

# IGBT - Field Stop, Trench

650 V, 40 A

## FGH40T65SHDF

### Description

Using novel field stop IGBT technology, ON Semiconductor's new series of field stop 3<sup>rd</sup> generation IGBTs offer superior conduction and switching performance and easy parallel operation. This device is well suited for the resonant or soft switching application such as induction heating and MWO.

### Features

- Maximum Junction Temperature:  $T_J = 175^{\circ}\text{C}$
- Positive Temperature Co-efficient for Easy Parallel Operating
- High Current Capability
- Low Saturation Voltage:  $V_{CE(sat)} = 1.45 \text{ V(Typ.) @ } I_C = 40 \text{ A}$
- 100% of the Parts Tested for  $I_{LM}$  (Note 1)
- High Input Impedance
- Fast Switching
- Tighten Parameter Distribution
- This Device is Pb-Free and is RoHS Compliant

### Applications

- Induction Heating, MWO



ON Semiconductor®

[www.onsemi.com](http://www.onsemi.com)

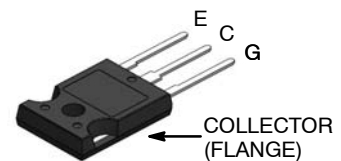
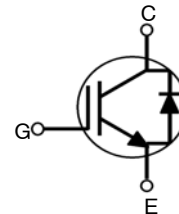

TO-247-3LD  
CASE 340CH

### MARKING DIAGRAM

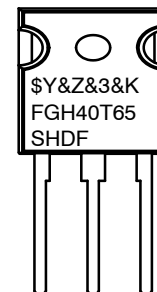

\$Y	= ON Semiconductor Logo
&Z	= Assembly Plant Code
&3	= Numeric Date Code
&K	= Lot Code
FGH40T65SHDF	= Specific Device Code

### ORDERING INFORMATION

See detailed ordering and shipping information in the package dimensions section on page 2 of this data sheet.

# FGH40T65SHDF

## ABSOLUTE MAXIMUM RATINGS

Description		Symbol	FGH40T65SHDF-F155	Unit
Collector to Emitter Voltage		$V_{CES}$	650	V
Gate to Emitter Voltage		$V_{GES}$	$\pm 20$	V
Transient Gate to Emitter Voltage			$\pm 30$	V
Collector Current	$T_C = 25^\circ\text{C}$	$I_C$	80	A
Collector Current	$T_C = 100^\circ\text{C}$		40	A
Pulsed Collector Current (Note 1)	$T_C = 25^\circ\text{C}$	$I_{LM}$	120	A
Pulsed Collector Current (Note 2)		$I_{CM}$	120	A
Diode Forward Current	$T_C = 25^\circ\text{C}$	$I_F$	40	A
Diode Forward Current	$T_C = 100^\circ\text{C}$		20	A
Pulsed Diode Maximum Forward Current		$I_{FM}$	60	A
Maximum Power Dissipation	$T_C = 25^\circ\text{C}$	$P_D$	268	W
Maximum Power Dissipation	$T_C = 100^\circ\text{C}$		134	W
Operating Junction Temperature		$T_J$	-55 to +175	$^\circ\text{C}$
Storage Temperature Range		$T_{stg}$	-55 to +175	$^\circ\text{C}$
Maximum Lead Temp. for Soldering Purposes, 1/8" from Case for 5 Seconds		$T_L$	300	$^\circ\text{C}$

Stresses exceeding those listed in the Maximum Ratings table may damage the device. If any of these limits are exceeded, device functionality should not be assumed, damage may occur and reliability may be affected.

- $V_{CC} = 400\text{ V}$ ,  $V_{GE} = 15\text{ V}$ ,  $I_C = 120\text{ A}$ ,  $R_G = 30\ \Omega$ , Inductive Load
- Repetitive Rating: Pulse width limited by max. junction temperature.

## THERMAL CHARACTERISTICS

Parameter	Symbol	FGH40T65SHDF-F155	Unit
Thermal Resistance, Junction to Case (IGBT)	$R_{\theta JC}$	0.56	$^\circ\text{C}/\text{W}$
Thermal Resistance, Junction to Case (Diode)	$R_{\theta JC}$	1.75	$^\circ\text{C}/\text{W}$
Thermal Resistance, Junction to Ambient	$R_{\theta JA}$	40	$^\circ\text{C}/\text{W}$

## PACKAGE MARKING AND ORDERING INFORMATION

Device Marking	Device	Package	Reel Size	Tape Width	Quantity
FGH40T65SHDF	FGH40T65SHDF-F155	TO-247-3LD	-	-	30

## ELECTRICAL CHARACTERISTICS OF THE IGBT ( $T_C = 25^\circ\text{C}$ unless otherwise noted)

Parameter	Symbol	Test Conditions	Min	Typ	Max	Unit
-----------	--------	-----------------	-----	-----	-----	------

### OFF CHARACTERISTICS

Collector to Emitter Breakdown Voltage	$BV_{CES}$	$V_{GE} = 0\text{ V}$ , $I_C = 1\text{ mA}$	650	-	-	V
Temperature Coefficient of Breakdown Voltage	$\Delta BV_{CES}/\Delta T_J$	$V_{GE} = 0\text{ V}$ , $I_C = 1\text{ mA}$		0.6		$\text{V}/^\circ\text{C}$
Collector Cut-Off Current	$I_{CES}$	$V_{CE} = V_{CES}$ , $V_{GE} = 0\text{ V}$	-	-	250	$\mu\text{A}$
G-E Leakage Current	$I_{GES}$	$V_{GE} = V_{GES}$ , $V_{CE} = 0\text{ V}$	-	-	$\pm 400$	nA

### ON CHARACTERISTICS

G-E Threshold Voltage	$V_{GE(th)}$	$I_C = 40\text{ mA}$ , $V_{CE} = V_{GE}$	3.5	5.5	7.5	V
Collector to Emitter Saturation Voltage	$V_{CE(sat)}$	$I_C = 40\text{ A}$ , $V_{GE} = 15\text{ V}$	-	1.45	1.85	V
		$I_C = 40\text{ A}$ , $V_{GE} = 15\text{ V}$ , $T_C = 175^\circ\text{C}$	-	1.8	-	V

# FGH40T65SHDF

## ELECTRICAL CHARACTERISTICS OF THE IGBT ( $T_C = 25^\circ\text{C}$ unless otherwise noted) (continued)

Parameter	Symbol	Test Conditions	Min	Typ	Max	Unit
<b>DYNAMIC CHARACTERISTICS</b>						
Input Capacitance	$C_{ies}$	$V_{CE} = 30\text{ V}, V_{GE} = 0\text{ V}, f = 1\text{ MHz}$	-	1982	-	pF
Output Capacitance	$C_{oes}$		-	70	-	pF
Reverse Transfer Capacitance	$C_{res}$		-	25	-	pF

## SWITCHING CHARACTERISTICS

Turn-On Delay Time	$T_{d(on)}$	$V_{CC} = 400\text{ V}, I_C = 40\text{ A},$ $R_G = 6\ \Omega, V_{GE} = 15\text{ V},$ Inductive Load, $T_C = 25^\circ\text{C}$	-	18	-	ns
Rise Time	$T_r$		-	27	-	ns
Turn-Off Delay Time	$T_{d(off)}$		-	64	-	ns
Fall Time	$T_f$		-	3	-	ns
Turn-On Switching Loss	$E_{on}$		-	1.22	-	mJ
Turn-Off Switching Loss	$E_{off}$		-	0.44	-	mJ
Total Switching Loss	$E_{ts}$		-	1.66	-	mJ
Turn-On Delay Time	$T_{d(on)}$	$V_{CC} = 400\text{ V}, I_C = 40\text{ A},$ $R_G = 6\ \Omega, V_{GE} = 15\text{ V},$ Inductive Load, $T_C = 175^\circ\text{C}$	-	18	-	ns
Rise Time	$T_r$		-	31	-	ns
Turn-Off Delay Time	$T_{d(off)}$		-	70	-	ns
Fall Time	$T_f$		-	56	-	ns
Turn-On Switching Loss	$E_{on}$		-	1.78	-	mJ
Turn-Off Switching Loss	$E_{off}$		-	0.78	-	mJ
Total Switching Loss	$E_{ts}$		-	2.56	-	mJ
Total Gate Charge	$Q_g$	$V_{CC} = 400\text{ V}, I_C = 40\text{ A},$ $V_{GE} = 15\text{ V}$	-	68	-	nC
Gate to Emitter Charge	$Q_{ge}$		-	12	-	nC
Gate to Collector Charge	$Q_{gc}$		-	25	-	nC

## ELECTRICAL CHARACTERISTICS OF THE DIODE ( $T_J = 25^\circ\text{C}$ unless otherwise noted)

Parameter	Symbol	Test Conditions	Min	Typ	Max	Unit	
Diode Forward Voltage	$V_{FM}$	$I_F = 20\text{ A}$	$T_C = 25^\circ\text{C}$	-	1.5	1.95	V
			$T_C = 175^\circ\text{C}$	-	1.37	-	
Reverse Recovery Energy	$E_{rec}$	$I_F = 20\text{ A},$ $di_F/dt = 200\text{ A}/\mu\text{s}$	$T_C = 175^\circ\text{C}$	-	153	-	$\mu\text{J}$
Diode Reverse Recovery Time	$T_{rr}$		$T_C = 25^\circ\text{C}$	-	101	-	ns
			$T_C = 175^\circ\text{C}$	-	238	-	
Diode Reverse Recovery Charge	$Q_{rr}$		$T_C = 25^\circ\text{C}$	-	343	-	nC
		$T_C = 175^\circ\text{C}$	-	1493	-		

Product parametric performance is indicated in the Electrical Characteristics for the listed test conditions, unless otherwise noted. Product performance may not be indicated by the Electrical Characteristics if operated under different conditions.

TYPICAL PERFORMANCE CHARACTERISTICS

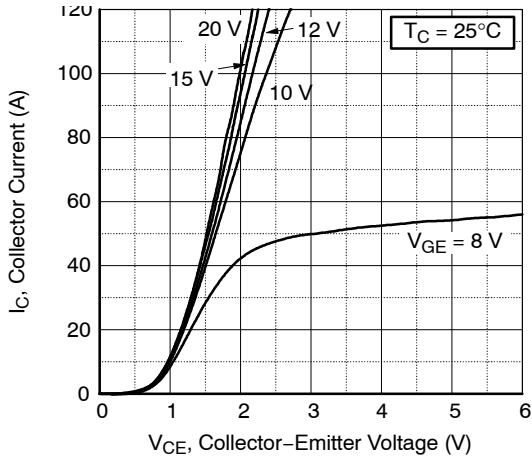

Figure 1. Typical Output Characteristics

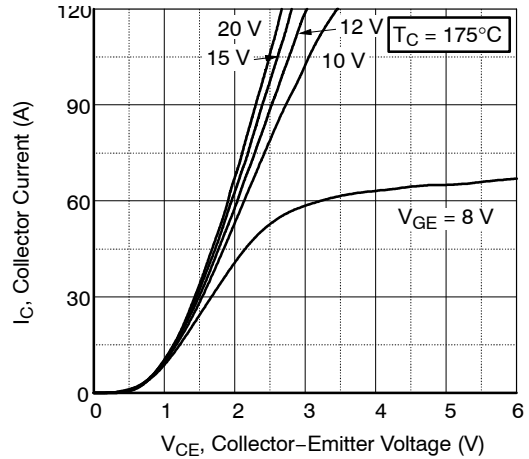

Figure 2. Typical Output Characteristics

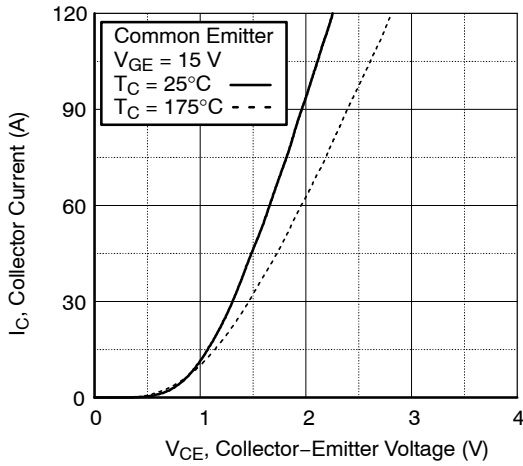

Figure 3. Typical Saturation Voltage Characteristics

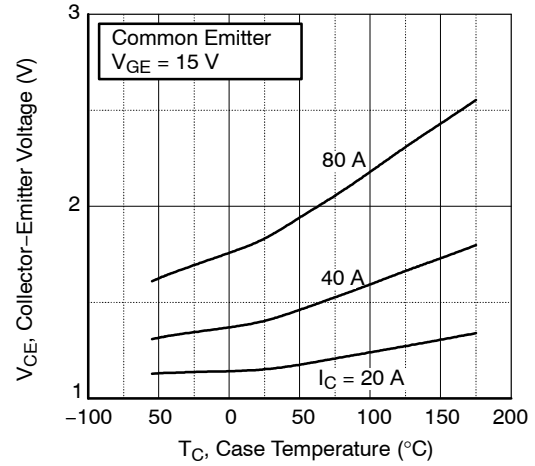

Figure 4. Saturation Voltage vs. Case Temperature at Variant Current Level

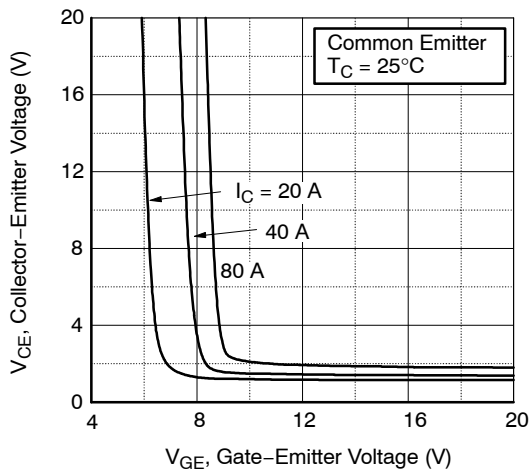

Figure 5. Saturation Voltage vs Vge

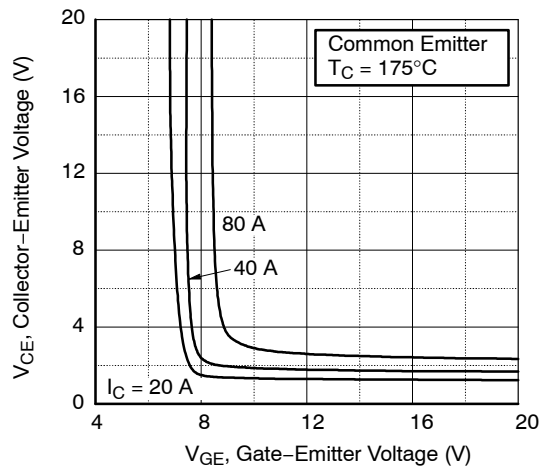

Figure 6. Saturation Voltage vs Vge

TYPICAL PERFORMANCE CHARACTERISTICS (continued)

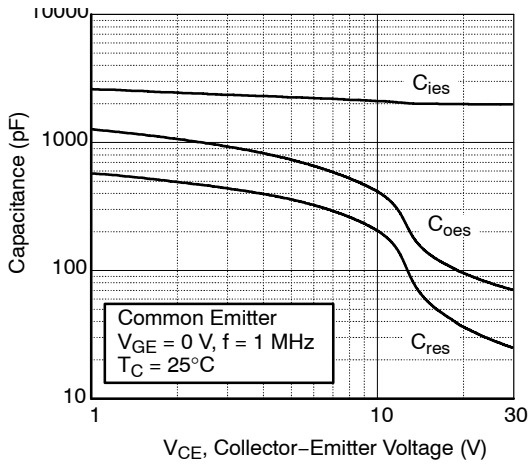

Figure 7. Capacitance Characteristics

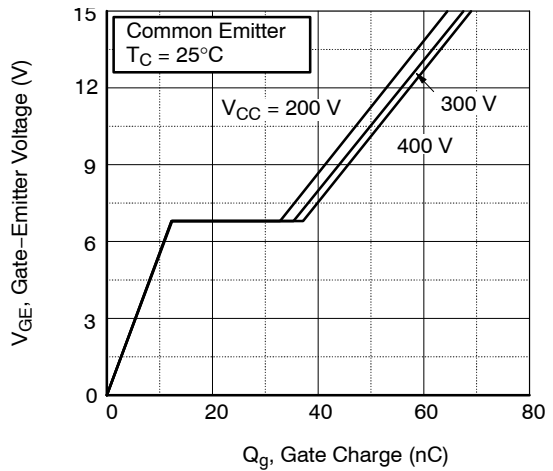

Figure 8. Gate Charge Characteristics

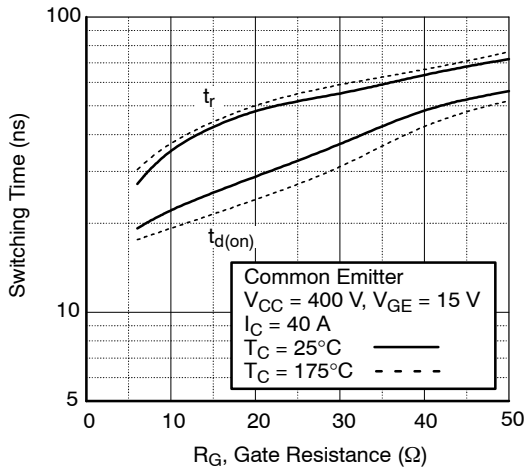

Figure 9. Turn-On Characteristics vs. Gate Resistance

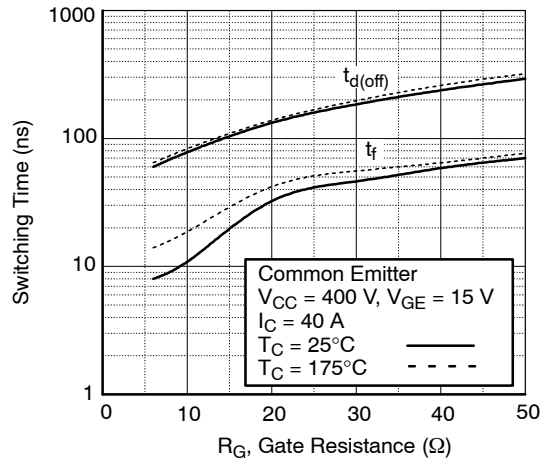

Figure 10. Turn-Off Characteristics vs. Gate Resistance

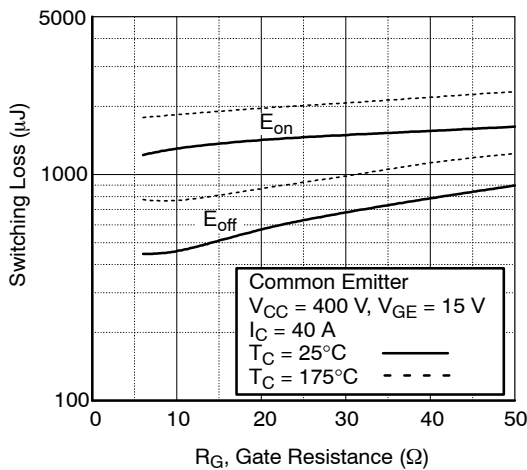

Figure 11. Switching Loss vs. Gate Resistance

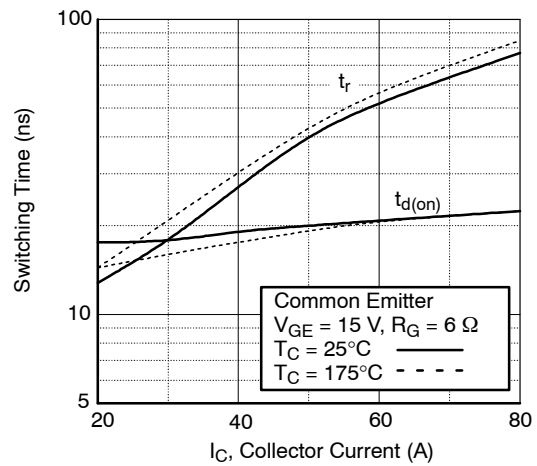

Figure 12. Turn-On Characteristics vs. Collector Current

TYPICAL PERFORMANCE CHARACTERISTICS (continued)

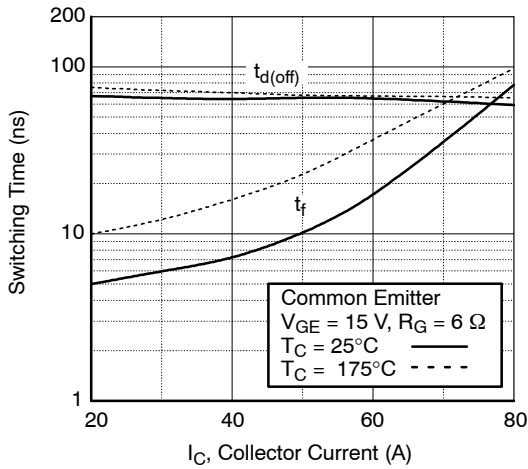

Figure 13. Turn-Off Characteristics vs. Collector Current

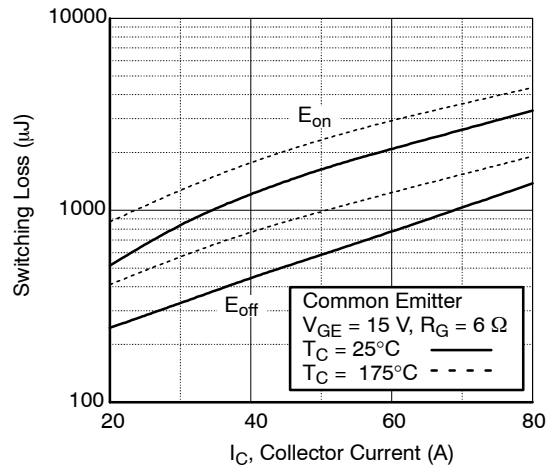

Figure 14. Switching Loss vs. Collector Current

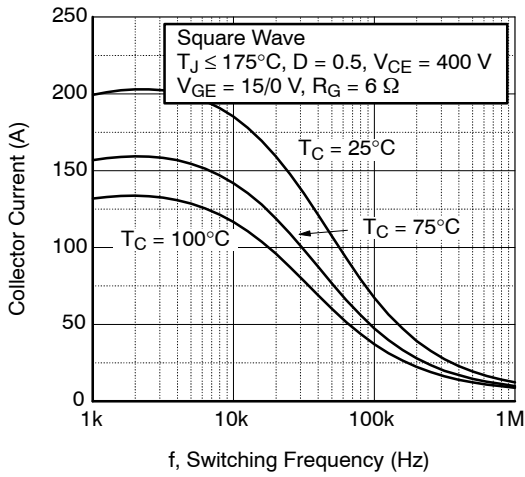

Figure 15. Load Current vs. Frequency

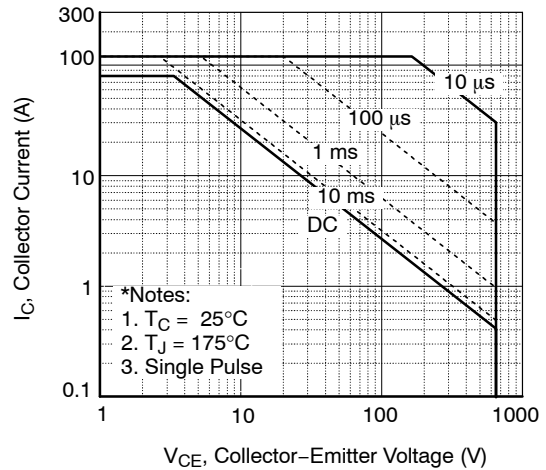

Figure 16. SOA Characteristics

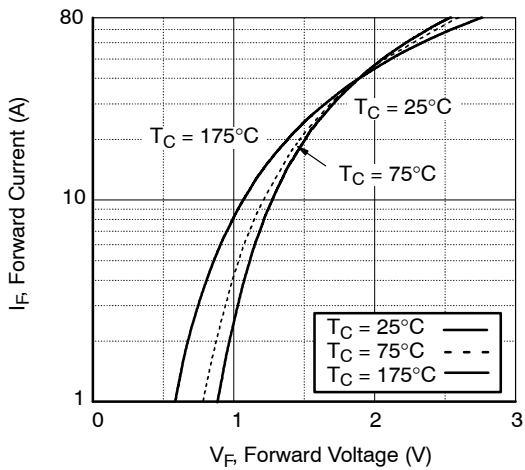

Figure 17. Forward Characteristics

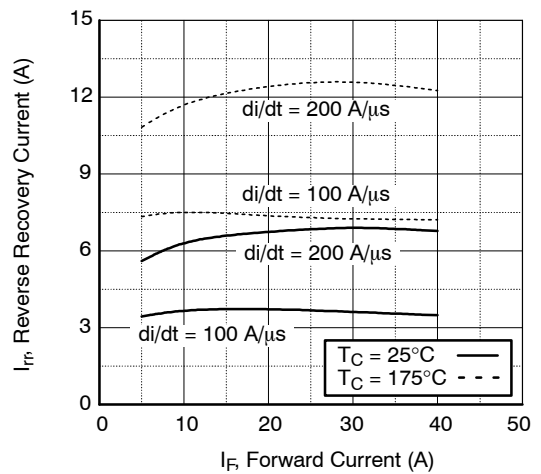

Figure 18. Reverse Recovery Current

# FGH40T65SHDF

## TYPICAL PERFORMANCE CHARACTERISTICS (continued)

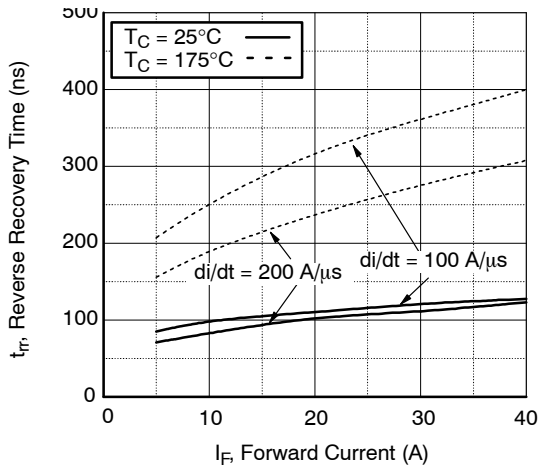

Figure 19. Reverse Recovery Time

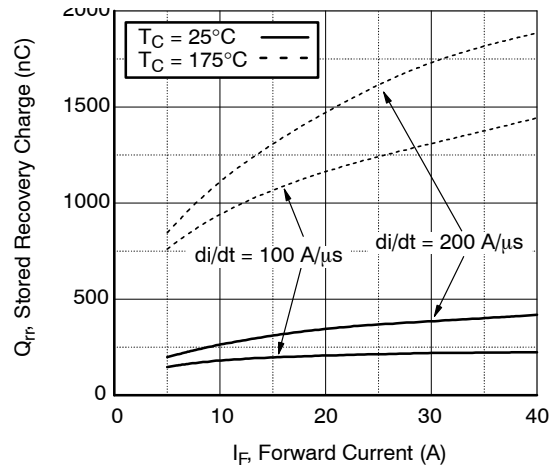

Figure 20. Stored Charge

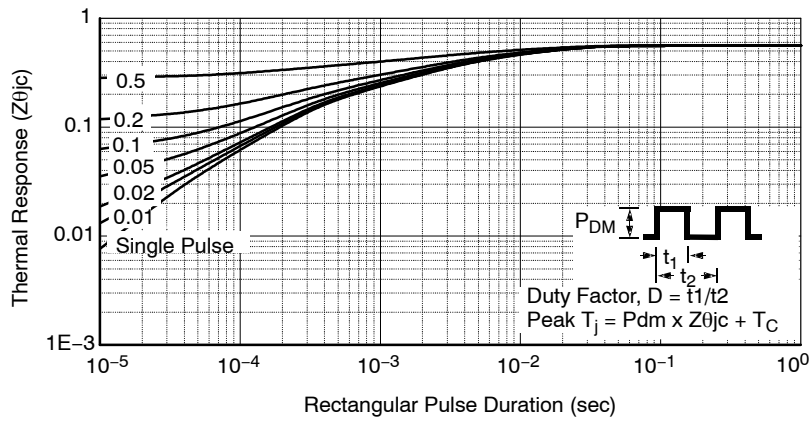

Figure 21. Transient Thermal Impedance of IGBT

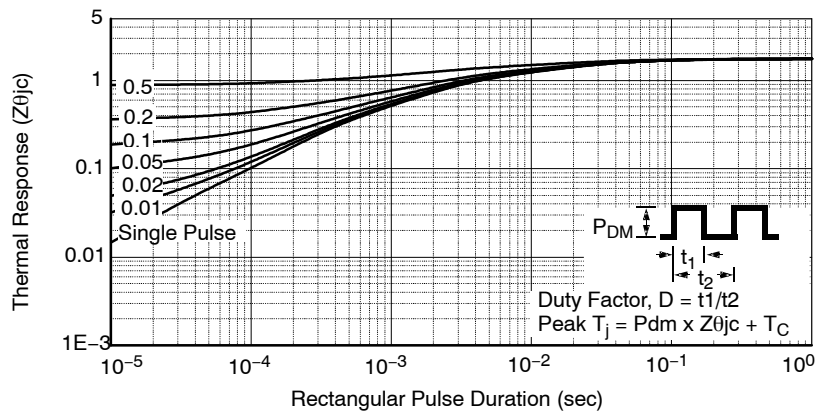
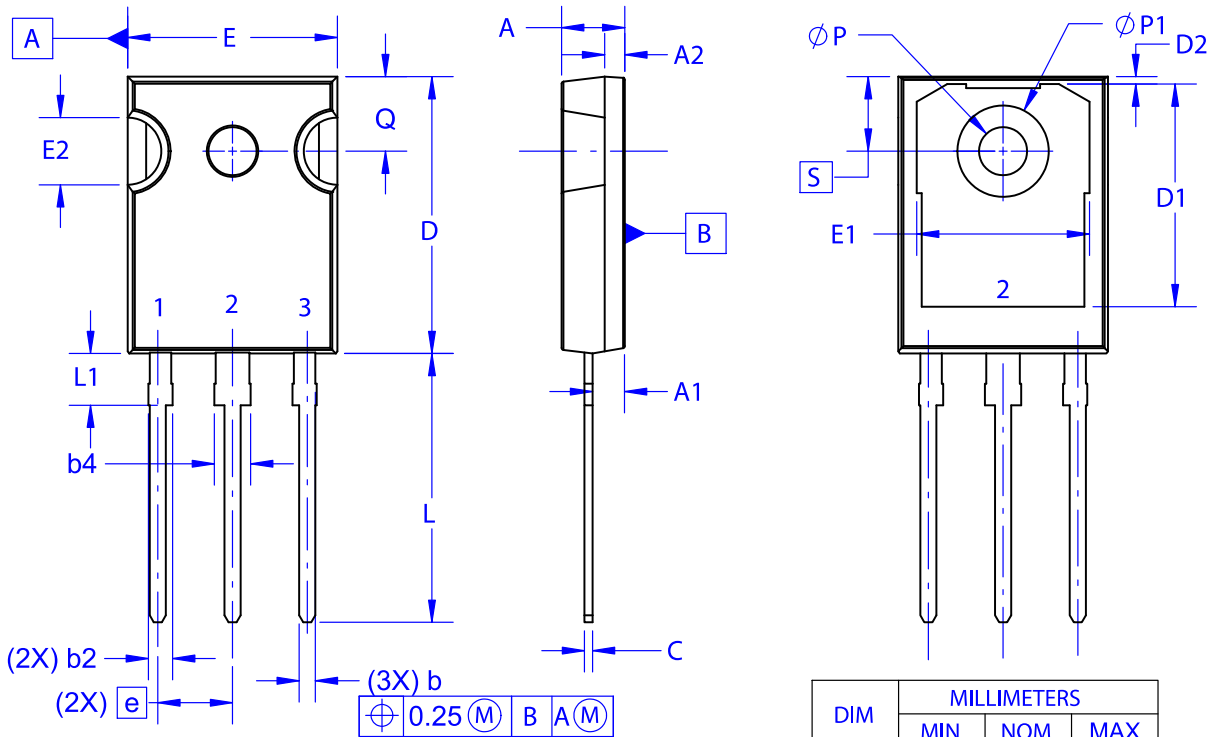

Figure 22. Transient Thermal Impedance of Diode

**TO-247-3LD  
CASE 340CH  
ISSUE A**

DATE 09 OCT 2019



NOTES: UNLESS OTHERWISE SPECIFIED.

- A. DIMENSIONS ARE EXCLUSIVE OF BURRS, MOLD FLASH, AND TIE BAR EXTRUSIONS.
- B. ALL DIMENSIONS ARE IN MILLIMETERS.
- C. DRAWING CONFORMS TO ASME Y14.5 - 2009.
- D. DIMENSION A1 TO BE MEASURED IN THE REGION DEFINED BY L1.
- E. LEAD FINISH IS UNCONTROLLED IN THE REGION DEFINED BY L1.

**GENERIC  
MARKING DIAGRAM\***

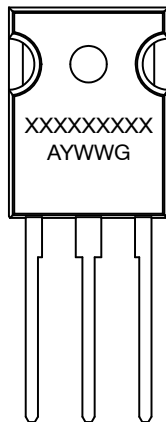

XXXX = Specific Device Code  
 A = Assembly Location  
 Y = Year  
 WW = Work Week  
 G = Pb-Free Package

\*This information is generic. Please refer to device data sheet for actual part marking. Pb-Free indicator, "G" or microdot "•", may or may not be present. Some products may not follow the Generic Marking.

DIM	MILLIMETERS		
	MIN	NOM	MAX
A	4.58	4.70	4.82
A1	2.29	2.475	2.66
A2	1.40	1.50	1.60
D	20.32	20.57	20.82
E	15.37	15.62	15.87
E2	4.96	5.08	5.20
e	~	5.56	~
L	19.75	20.00	20.25
L1	3.69	3.81	3.93
ØP	3.51	3.58	3.65
Q	5.34	5.46	5.58
S	5.34	5.46	5.58
b	1.17	1.26	1.35
b2	1.53	1.65	1.77
b4	2.42	2.54	2.66
c	0.51	0.61	0.71
D1	13.08	~	~
D2	0.51	0.93	1.35
E1	12.81	~	~
ØP1	6.61	6.73	6.85

<b>DOCUMENT NUMBER:</b>	<b>98AON13853G</b>	Electronic versions are uncontrolled except when accessed directly from the Document Repository. Printed versions are uncontrolled except when stamped "CONTROLLED COPY" in red.
<b>DESCRIPTION:</b>	<b>TO-247-3LD</b>	<b>PAGE 1 OF 1</b>

onsemi and Onsemi are trademarks of Semiconductor Components Industries, LLC dba onsemi or its subsidiaries in the United States and/or other countries. onsemi reserves the right to make changes without further notice to any products herein. onsemi makes no warranty, representation or guarantee regarding the suitability of its products for any particular purpose, nor does onsemi assume any liability arising out of the application or use of any product or circuit, and specifically disclaims any and all liability, including without limitation special, consequential or incidental damages. onsemi does not convey any license under its patent rights nor the rights of others.



**onsemi**, **Onsemi**, and other names, marks, and brands are registered and/or common law trademarks of Semiconductor Components Industries, LLC dba "**onsemi**" or its affiliates and/or subsidiaries in the United States and/or other countries. **onsemi** owns the rights to a number of patents, trademarks, copyrights, trade secrets, and other intellectual property. A listing of **onsemi**'s product/patent coverage may be accessed at [www.onsemi.com/site/pdf/Patent-Marking.pdf](http://www.onsemi.com/site/pdf/Patent-Marking.pdf). **onsemi** reserves the right to make changes at any time to any products or information herein, without notice. The information herein is provided "as-is" and **onsemi** makes no warranty, representation or guarantee regarding the accuracy of the information, product features, availability, functionality, or suitability of its products for any particular purpose, nor does **onsemi** assume any liability arising out of the application or use of any product or circuit, and specifically disclaims any and all liability, including without limitation special, consequential or incidental damages. Buyer is responsible for its products and applications using **onsemi** products, including compliance with all laws, regulations and safety requirements or standards, regardless of any support or applications information provided by **onsemi**. "Typical" parameters which may be provided in **onsemi** data sheets and/or specifications can and do vary in different applications and actual performance may vary over time. All operating parameters, including "Typicals" must be validated for each customer application by customer's technical experts. **onsemi** does not convey any license under any of its intellectual property rights nor the rights of others. **onsemi** products are not designed, intended, or authorized for use as a critical component in life support systems or any FDA Class 3 medical devices or medical devices with a same or similar classification in a foreign jurisdiction or any devices intended for implantation in the human body. Should Buyer purchase or use **onsemi** products for any such unintended or unauthorized application, Buyer shall indemnify and hold **onsemi** and its officers, employees, subsidiaries, affiliates, and distributors harmless against all claims, costs, damages, and expenses, and reasonable attorney fees arising out of, directly or indirectly, any claim of personal injury or death associated with such unintended or unauthorized use, even if such claim alleges that **onsemi** was negligent regarding the design or manufacture of the part. **onsemi** is an Equal Opportunity/Affirmative Action Employer. This literature is subject to all applicable copyright laws and is not for resale in any manner.

## ADDITIONAL INFORMATION

### TECHNICAL PUBLICATIONS:

Technical Library: [www.onsemi.com/design/resources/technical-documentation](http://www.onsemi.com/design/resources/technical-documentation)  
onsemi Website: [www.onsemi.com](http://www.onsemi.com)

### ONLINE SUPPORT: [www.onsemi.com/support](http://www.onsemi.com/support)

For additional information, please contact your local Sales Representative at [www.onsemi.com/support/sales](http://www.onsemi.com/support/sales)