



SGM8061/SGM8062/SGM8063 500MHz, Rail-to-Rail Output, CMOS Operational Amplifiers

GENERAL DESCRIPTION

The SGM8061 (single), SGM8062 (dual) and SGM8063 (single with shutdown) are high speed operational amplifiers, which can operate from 2.5V to 5.5V single supply. The SGM8061/2/3 feature an 8mV maximum input offset voltage and offer a low supply current of 8.2mA/amplifier.

The SGM8061/2/3 have excellent performance. They have a bandwidth and slew rate usually exist in current feedback amplifiers. They exhibit a wide bandwidth of 500MHz ($G=+1$) and a 0.1dB gain flatness of 130MHz ($G=+1$).

The SGM8061/2/3 provide wide input common mode voltage range and rail-to-rail output swing. The fast settling time and low distortion make the operational amplifiers appropriate for high speed ADC/DAC. The supply current of SGM8063 is 75 μ A in shutdown mode. The devices are suitable for use in portable instrumentation and battery-powered systems.

The single SGM8061 is available in Green SOT-23-5 and SOIC-8 packages. The dual SGM8062 is available in Green SOIC-8 and MSOP-8 packages. The single with shutdown SGM8063 is available in Green SOT-23-6 and SOIC-8 packages. They are specified over the extended -40°C to $+125^{\circ}\text{C}$ temperature range.

FEATURES

- **High Speed:**
 - 3dB Bandwidth ($G = +1$): 500MHz
 - Slew Rate: 420V/ μ s
 - Settling Time to 0.1% with 2V Step: 16ns
- **Excellent Video Performance ($R_L = 150\Omega$, $G = +2$):**
 - 0.1dB Gain Flatness: 80MHz
 - Diff Gain: 0.015%, Diff Phase: 0.05°
- **Input Offset Voltage: 8mV (MAX)**
- **Rail-to-Rail Output**
- **Supply Voltage Range: 2.5V to 5.5V**
- **Input Common Mode Voltage Range:**
 - 0.2V to 3.8V with $V_S = 5V$
- **Low Supply Current:**
 - 8.2mA/Amplifier (TYP)
 - 75 μ A Shutdown Current for SGM8063
- **-40°C to +125°C Operating Temperature Range**
- **Small Packaging:**
 - SGM8061 Available in Green SOT-23-5 and SOIC-8 Packages
 - SGM8062 Available in Green MSOP-8 and SOIC-8 Packages
 - SGM8063 Available in Green SOT-23-6 and SOIC-8 Packages

APPLICATIONS

ADC
DVD
Filter
Hand Set
Imaging
Base Station
Photodiode Preamp

PACKAGE/ORDERING INFORMATION

MODEL	PACKAGE DESCRIPTION	SPECIFIED TEMPERATURE RANGE	ORDERING NUMBER	PACKAGE MARKING	PACKING OPTION
SGM8061	SOT-23-5	-40°C to +125°C	SGM8061XN5/TR	8061	Tape and Reel, 3000
	SOIC-8	-40°C to +125°C	SGM8061XS/TR	SGM8061XS XXXXX	Tape and Reel, 2500
SGM8062	MSOP-8	-40°C to +125°C	SGM8062XMS/TR	SGM8062 XMS XXXXX	Tape and Reel, 3000
	SOIC-8	-40°C to +125°C	SGM8062XS/TR	SGM8062XS XXXXX	Tape and Reel, 2500
SGM8063	SOT-23-6	-40°C to +125°C	SGM8063XN6/TR	8063	Tape and Reel, 3000
	SOIC-8	-40°C to +125°C	SGM8063XS/TR	SGM8063XS XXXXX	Tape and Reel, 2500

MARKING INFORMATION

NOTE: XXXXX = Date Code and Vendor Code.

XXXXX

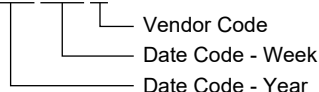

Green (RoHS & HSF): SG Micro Corp defines "Green" to mean Pb-Free (RoHS compatible) and free of halogen substances. If you have additional comments or questions, please contact your SGMICRO representative directly.

ABSOLUTE MAXIMUM RATINGS

- Supply Voltage, +V_S to -V_S.....6V
- Input Common Mode Voltage Range
..... (-V_S) - 0.3V to (+V_S) + 0.3V
- Package Thermal Resistance @ T_A = +25°C
- SOT-23-5, θ_{JA} 190°C/W
- SOT-23-6, θ_{JA} 190°C/W
- SOIC-8, θ_{JA} 125°C/W
- MSOP-8, θ_{JA} 155°C/W
- Junction Temperature+150°C
- Storage Temperature Range.....-65°C to +150°C
- Lead Temperature (Soldering, 10s)+260°C
- ESD Susceptibility
- HBM..... 1000V
- MM..... 400V

RECOMMENDED OPERATING CONDITIONS

- Operating Voltage Range.....2.5V to 5.5V
- Operating Temperature Range -40°C to +125°C

OVERSTRESS CAUTION

Stresses beyond those listed in Absolute Maximum Ratings may cause permanent damage to the device. Exposure to absolute maximum rating conditions for extended periods may affect reliability. Functional operation of the device at any conditions beyond those indicated in the Recommended Operating Conditions section is not implied.

ESD SENSITIVITY CAUTION

This integrated circuit can be damaged if ESD protections are not considered carefully. SGMICRO recommends that all integrated circuits be handled with appropriate precautions. Failure to observe proper handling and installation procedures can cause damage. ESD damage can range from subtle performance degradation to complete device failure. Precision integrated circuits may be more susceptible to damage because even small parametric changes could cause the device not to meet the published specifications.

DISCLAIMER

SG Micro Corp reserves the right to make any change in circuit design, or specifications without prior notice.

PIN CONFIGURATIONS

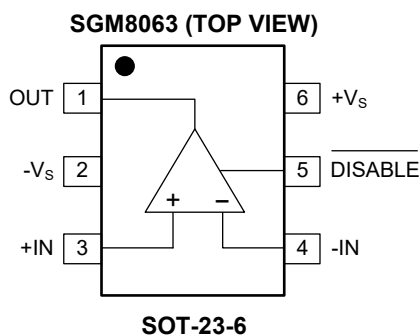
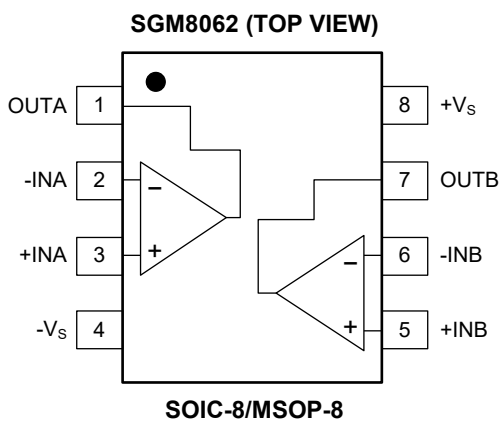
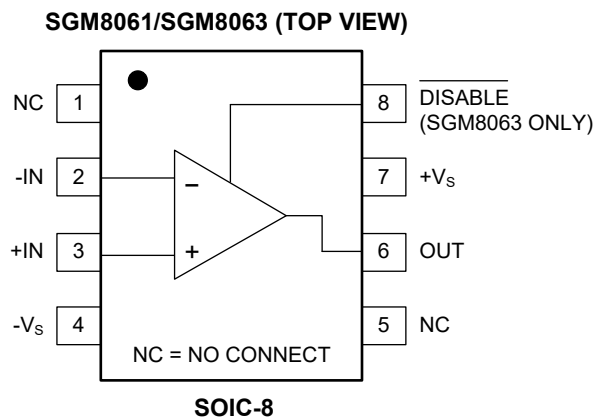
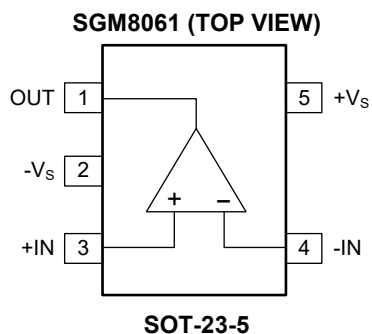

ELECTRICAL CHARACTERISTICS

(G = +2, R_F = 402Ω, R_L = 150Ω, unless otherwise noted.)

PARAMETER	CONDITIONS	SGM8061/2/3						UNITS	MIN /MAX
		TYP	MIN/MAX OVER TEMPERATURE						
		+25°C	+25°C	0°C to +70°C	-40°C to +85°C	-40°C to +125°C			
DYNAMIC PERFORMANCE									
-3dB Small-Signal Bandwidth	G = +1, V _{OUT} = 0.1V _{P-P} , R _F = 24Ω	500					MHz	TYP	
	G = +1, V _{OUT} = 0.1V _{P-P} , R _F = 24Ω, R _L = 1kΩ	550					MHz	TYP	
	G = +2, V _{OUT} = 0.1V _{P-P} , R _L = 50Ω	130					MHz	TYP	
	G = +2, V _{OUT} = 0.1V _{P-P} , R _L = 150Ω	210					MHz	TYP	
	G = +2, V _{OUT} = 0.1V _{P-P} , R _L = 1kΩ	250					MHz	TYP	
	G = +2, V _{OUT} = 0.1V _{P-P} , R _L = 10kΩ	420					MHz	TYP	
Gain-Bandwidth Product	G = +10, R _L = 150Ω	200					MHz	TYP	
	G = +10, R _L = 1kΩ	230					MHz	TYP	
Bandwidth for 0.1dB Flatness	G = +1, V _{OUT} = 0.1V _{P-P} , R _F = 24Ω	130					MHz	TYP	
	G = +2, V _{OUT} = 0.1V _{P-P} , R _F = 330Ω	80					MHz	TYP	
Slew Rate	G = +1, 2V Output Step	320/370					V/μs	TYP	
	G = +2, 2V Output Step	350/320					V/μs	TYP	
	G = +2, 4V Output Step	420/390					V/μs	TYP	
Rise-and-Fall Time	G = +2, V _{OUT} = 0.2V _{P-P} , 10% to 90%	4					ns	TYP	
	G = +2, V _{OUT} = 2V _{P-P} , 10% to 90%	4.5					ns	TYP	
Settling Time to 0.1%	G = +2, 2V Output Step	16					ns	TYP	
Overload Recovery Time	V _{IN} G = +V _S	6.2					ns	TYP	
NOISE/DISTORTION PERFORMANCE									
Input Voltage Noise Density	f = 1MHz	5.6					nV/√Hz	TYP	
Differential Gain Error (NTSC)	G = +2, R _L = 150Ω	0.015					%	TYP	
Differential Phase Error (NTSC)	G = +2, R _L = 150Ω	0.05					degree	TYP	
DC PERFORMANCE									
Input Offset Voltage (V _{OS})		±2	±8	±8.5	±9	±9.3	mV	MAX	
Input Offset Voltage Drift		3					μV/°C	TYP	
Input Bias Current (I _B)		6					pA	TYP	
Input Offset Current (I _{OS})		2					pA	TYP	
Open-Loop Gain (A _{OL})	V _{OUT} = 0.3V to 4.7V, R _L = 150Ω	80	75	75	74	70	dB	MIN	
	V _{OUT} = 0.2V to 4.8V, R _L = 1kΩ	104	90	90	89	80	dB	MIN	
INPUT CHARACTERISTICS									
Input Common Mode Voltage Range (V _{CM})		-0.2 to 3.8					V	TYP	
Common Mode Rejection Ratio (CMRR)	V _{CM} = -0.1V to 3.5V	80	66	65	64	62	dB	MIN	
OUTPUT CHARACTERISTICS									
Output Voltage Swing from Rail	R _L = 150Ω	0.12					V	TYP	
	R _L = 1kΩ	0.03					V	TYP	
Output Current		120	100	98	93	87	mA	MIN	
Closed-Loop Output Impedance	f < 100kHz	0.015					Ω	TYP	
POWER-DOWN DISABLE (SGM8063 ONLY)									
Turn-On Time		50					ns	TYP	
Turn-Off Time		44					ns	TYP	
DISABLE Voltage-Off			0.8				V	MAX	
DISABLE Voltage-On			2				V	MIN	
POWER SUPPLY									
Operating Voltage Range			2.5	2.7	2.7	2.7	V	MIN	
			5.5	5.5	5.5	5.5	V	MAX	
Quiescent Current/Amplifier		8.2	10	10.3	10.5	11	mA	MAX	
Supply Current when Disabled (SGM8063 only)		75	120	127	130	139	μA	MAX	
Power Supply Rejection Ratio (PSRR)	ΔV _S = 2.7V to 5.5V, V _{CM} = (-V _S) + 0.5V	80	66	66	65	63	dB	MIN	

TYPICAL PERFORMANCE CHARACTERISTICS

At $T_A = +25^\circ\text{C}$, $V_S = 5\text{V}$, $G = +2$, $R_F = 402\Omega$, $R_G = 402\Omega$, and $R_L = 150\Omega$ connected to $V_S/2$, unless otherwise noted.

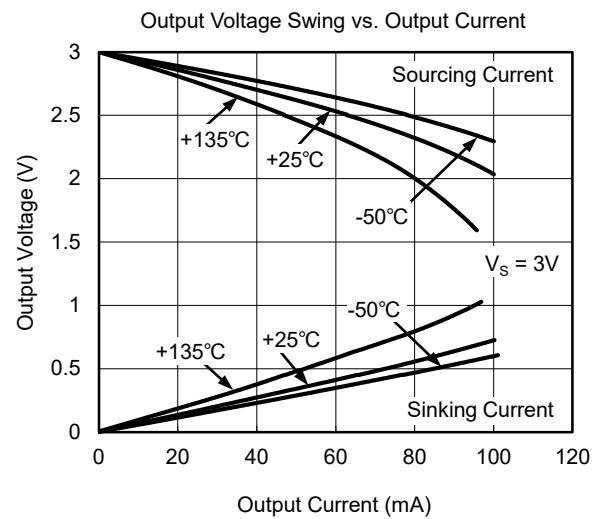
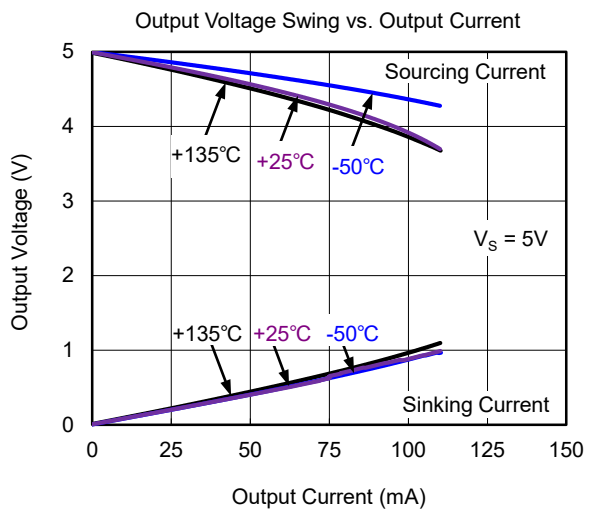
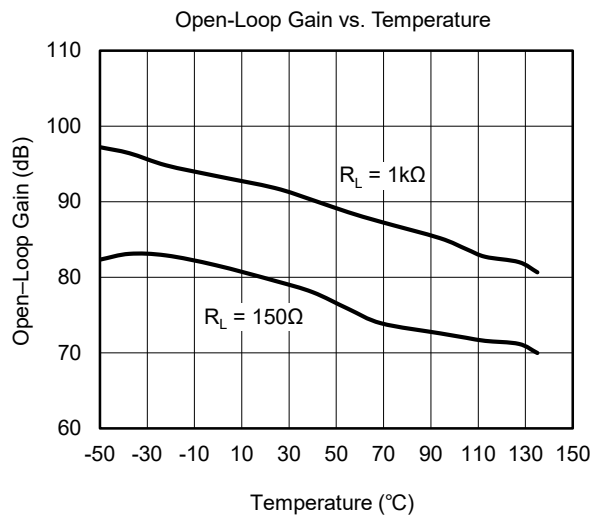
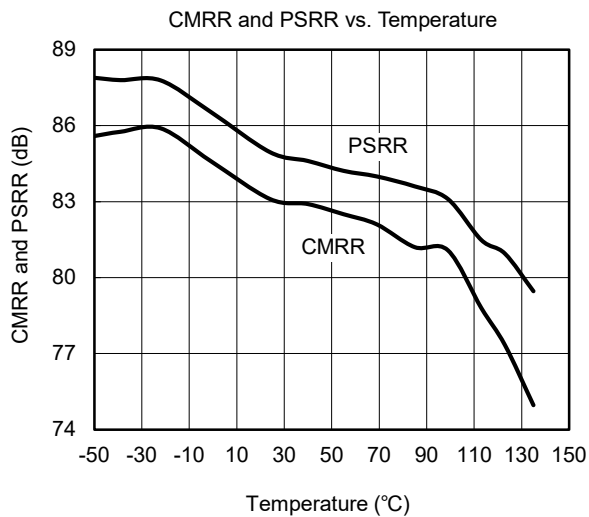
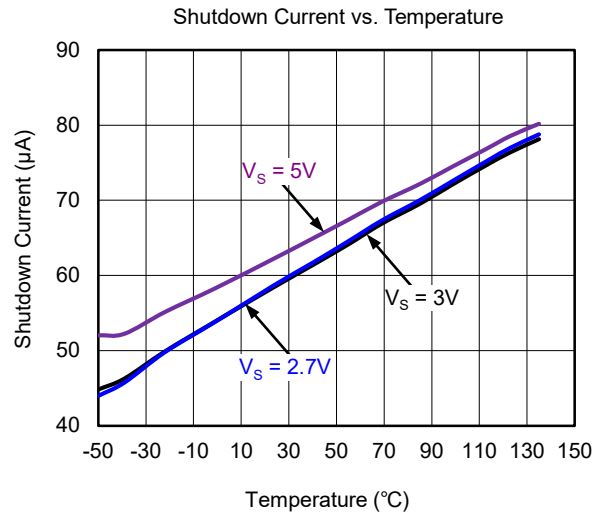
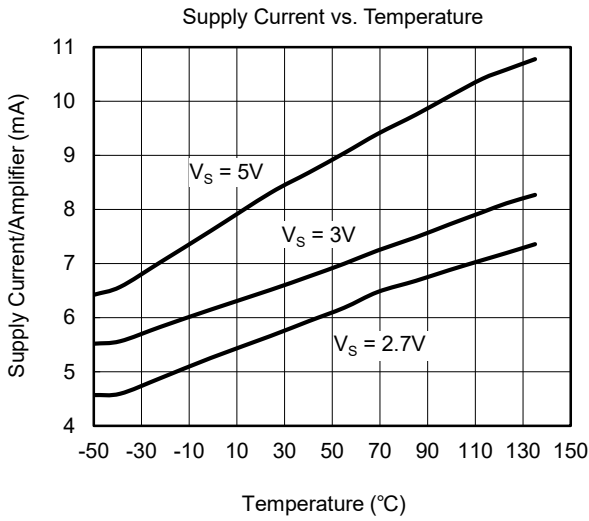

TYPICAL PERFORMANCE CHARACTERISTICS (continued)

At $T_A = +25^\circ\text{C}$, $V_S = 5\text{V}$, $G = +2$, $R_F = 402\Omega$, $R_G = 402\Omega$, and $R_L = 150\Omega$ connected to $V_S/2$, unless otherwise noted.

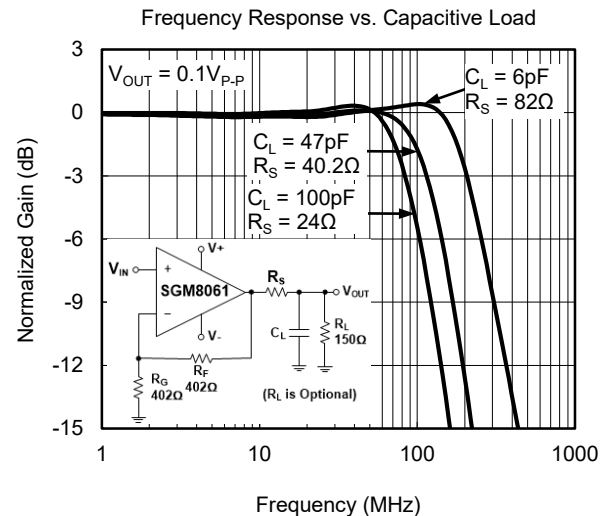
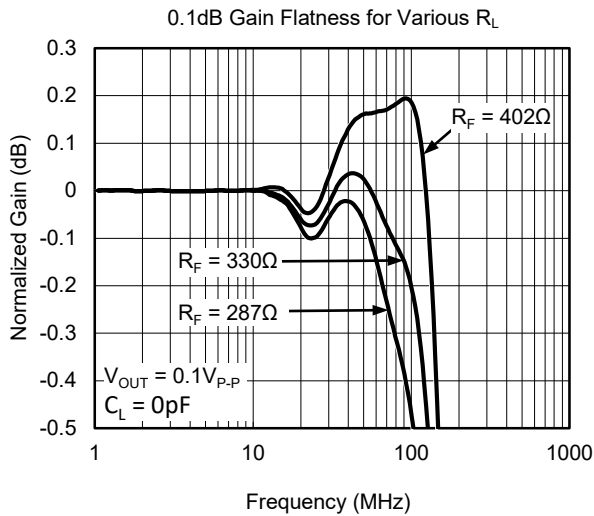
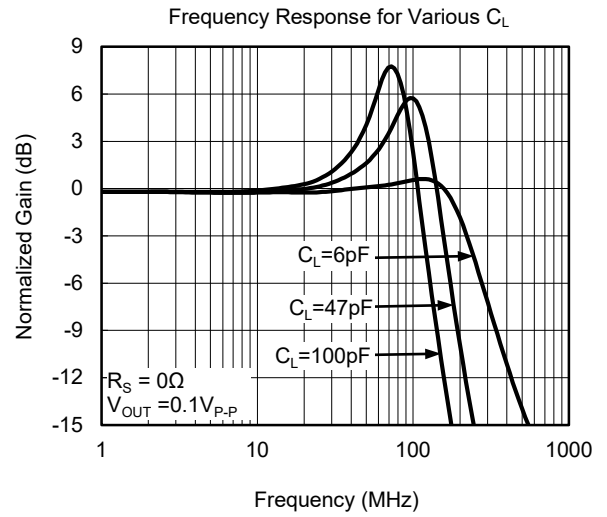
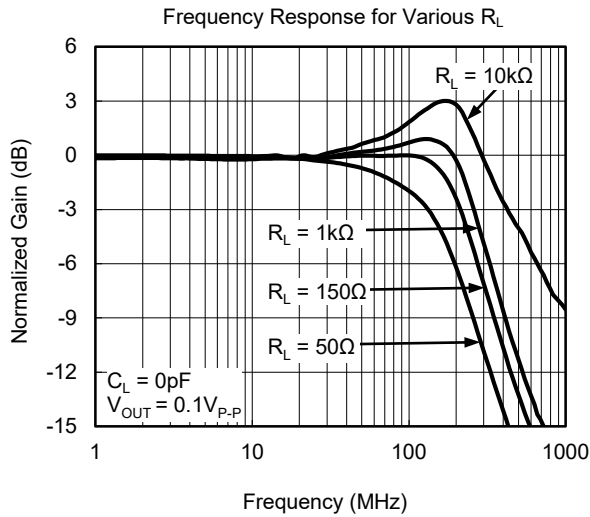
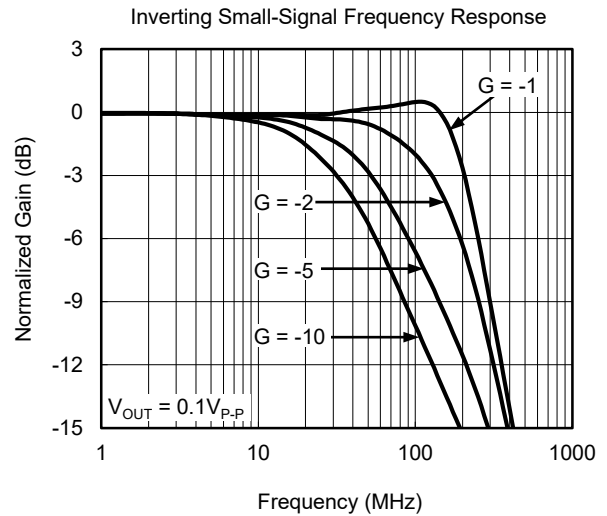
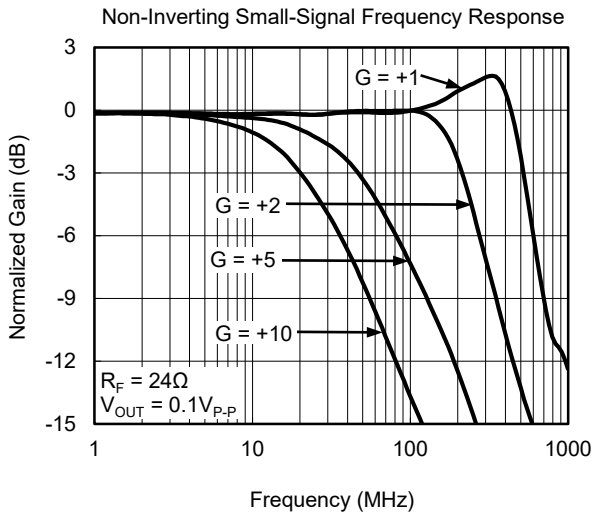

TYPICAL PERFORMANCE CHARACTERISTICS (continued)

At $T_A = +25^\circ\text{C}$, $V_S = 5\text{V}$, $G = +2$, $R_F = 402\Omega$, $R_G = 402\Omega$, and $R_L = 150\Omega$ connected to $V_S/2$, unless otherwise noted.

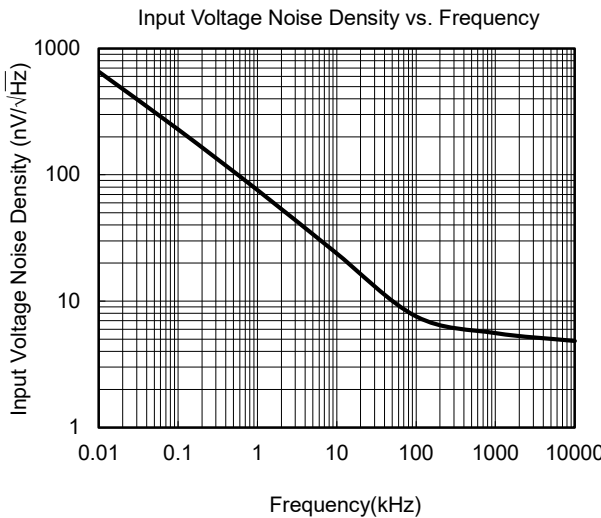
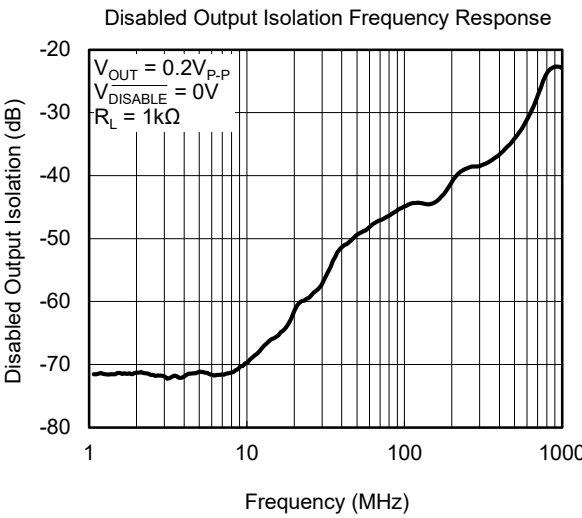
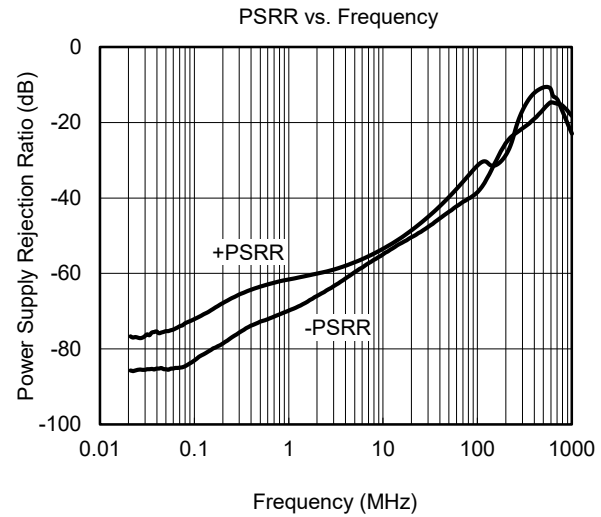
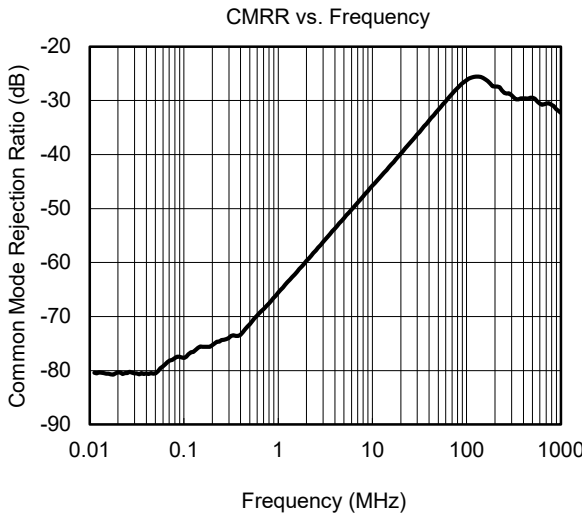
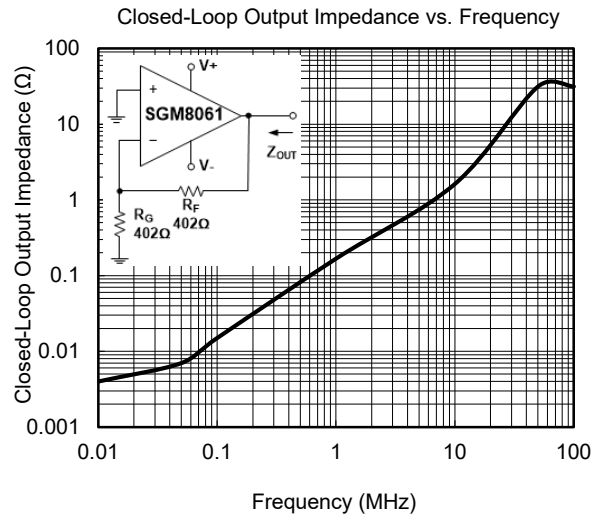
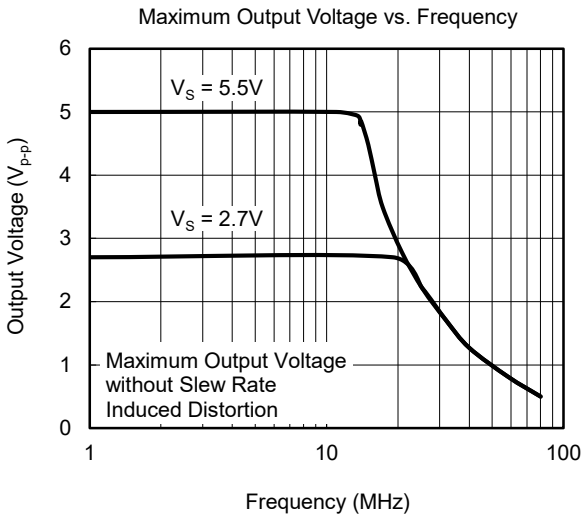

TYPICAL PERFORMANCE CHARACTERISTICS (continued)

At $T_A = +25^\circ\text{C}$, $V_S = 5\text{V}$, $G = +2$, $R_F = 402\Omega$, $R_G = 402\Omega$, and $R_L = 150\Omega$ connected to $V_S/2$, unless otherwise noted.

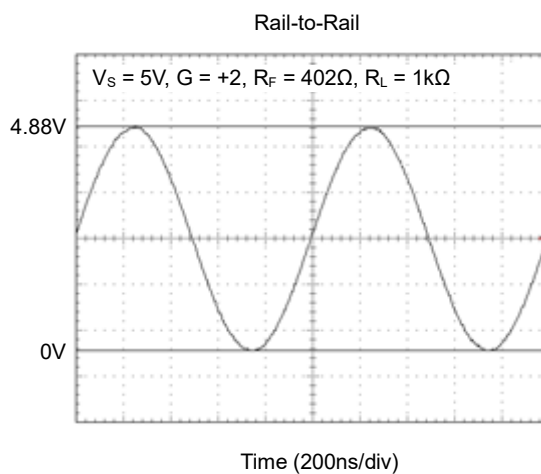
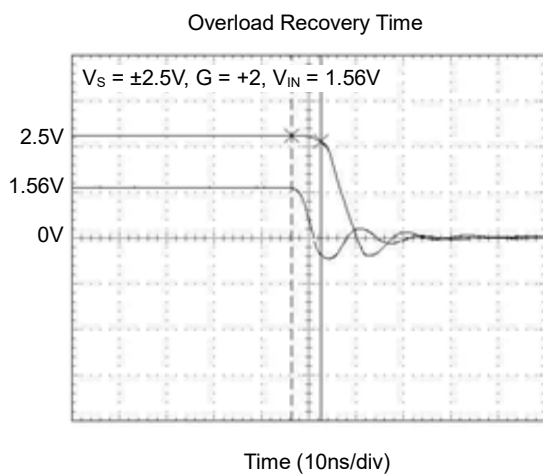
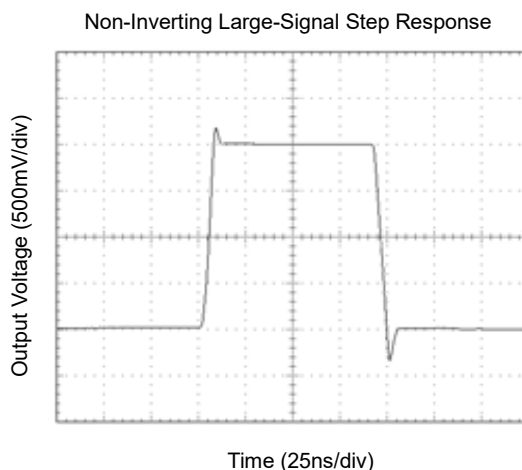
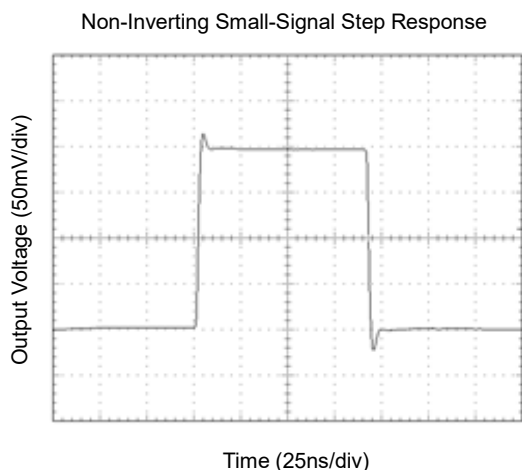
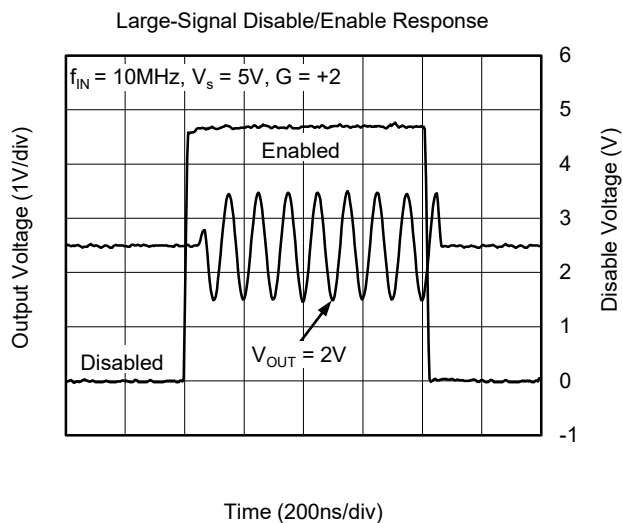
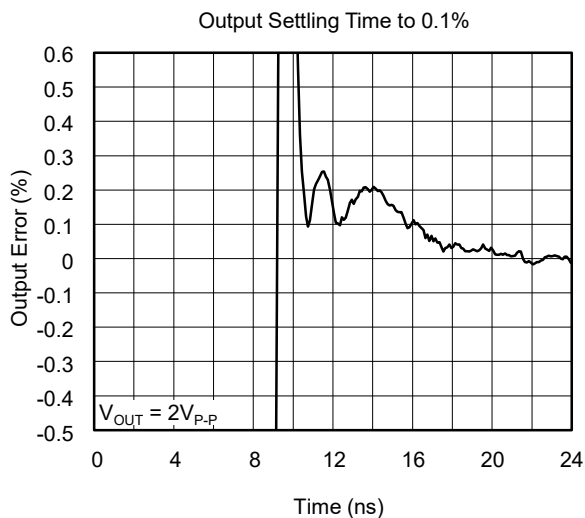

TYPICAL PERFORMANCE CHARACTERISTICS (continued)

At $T_A = +25^\circ\text{C}$, $V_S = 5\text{V}$, $G = +2$, $R_F = 402\Omega$, $R_G = 402\Omega$, and $R_L = 150\Omega$ connected to $V_S/2$, unless otherwise noted.

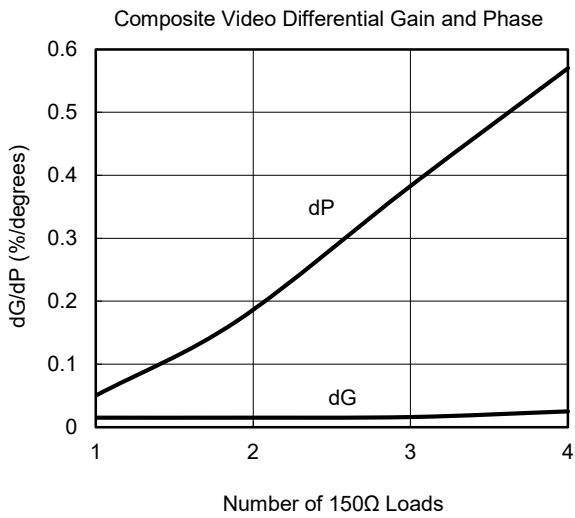

REVISION HISTORY

NOTE: Page numbers for previous revisions may differ from page numbers in the current version.

JANUARY 2019 – REV.A.1 to REV.A.2	Page
Added MSOP-8 Package.....	All
Changed Absolute Maximum Ratings section.....	2
Changed Driving Capacitive Loads section.....	10

MAY 2011 – REV.A to REV.A.1	Page
Changed Package name	All

Changes from Original (NOVEMBER 2006) to REV.A	Page
Changed from product preview to production data.....	All

PACKAGE OUTLINE DIMENSIONS

SOT-23-5



RECOMMENDED LAND PATTERN (Unit: mm)



Symbol	Dimensions In Millimeters		Dimensions In Inches	
	MIN	MAX	MIN	MAX
A	1.050	1.250	0.041	0.049
A1	0.000	0.100	0.000	0.004
A2	1.050	1.150	0.041	0.045
b	0.300	0.500	0.012	0.020
c	0.100	0.200	0.004	0.008
D	2.820	3.020	0.111	0.119
E	1.500	1.700	0.059	0.067
E1	2.650	2.950	0.104	0.116
e	0.950 BSC		0.037 BSC	
e1	1.900 BSC		0.075 BSC	
L	0.300	0.600	0.012	0.024
θ	0°	8°	0°	8°

PACKAGE OUTLINE DIMENSIONS

SOT-23-6

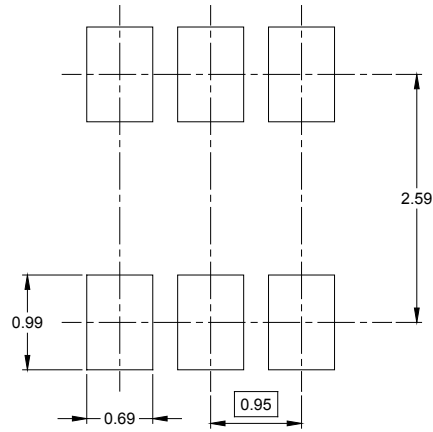
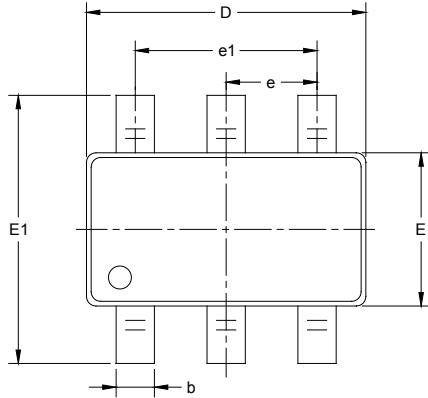

RECOMMENDED LAND PATTERN (Unit: mm)

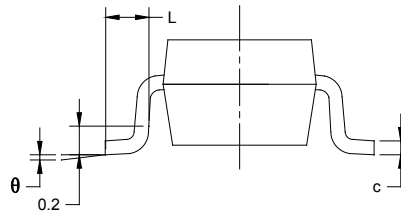
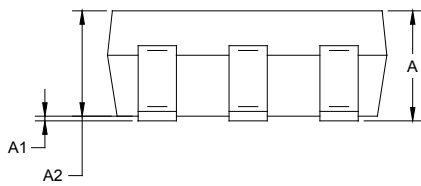

Symbol	Dimensions In Millimeters		Dimensions In Inches	
	MIN	MAX	MIN	MAX
A	1.050	1.250	0.041	0.049
A1	0.000	0.100	0.000	0.004
A2	1.050	1.150	0.041	0.045
b	0.300	0.500	0.012	0.020
c	0.100	0.200	0.004	0.008
D	2.820	3.020	0.111	0.119
E	1.500	1.700	0.059	0.067
E1	2.650	2.950	0.104	0.116
e	0.950 BSC		0.037 BSC	
e1	1.900 BSC		0.075 BSC	
L	0.300	0.600	0.012	0.024
θ	0°	8°	0°	8°

PACKAGE OUTLINE DIMENSIONS

MSOP-8



RECOMMENDED LAND PATTERN (Unit: mm)

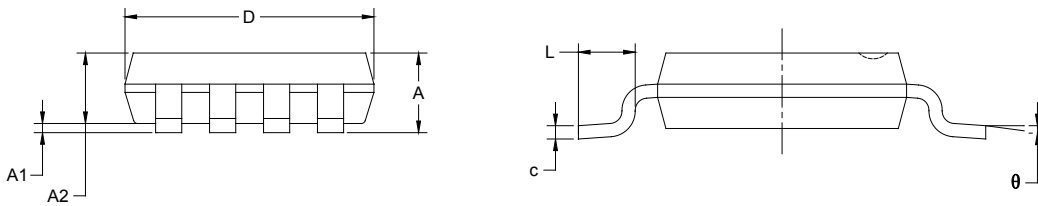

Symbol	Dimensions In Millimeters		Dimensions In Inches	
	MIN	MAX	MIN	MAX
A	0.820	1.100	0.032	0.043
A1	0.020	0.150	0.001	0.006
A2	0.750	0.950	0.030	0.037
b	0.250	0.380	0.010	0.015
c	0.090	0.230	0.004	0.009
D	2.900	3.100	0.114	0.122
E	2.900	3.100	0.114	0.122
E1	4.750	5.050	0.187	0.199
e	0.650 BSC		0.026 BSC	
L	0.400	0.800	0.016	0.031
θ	0°	6°	0°	6°

PACKAGE OUTLINE DIMENSIONS

SOIC-8

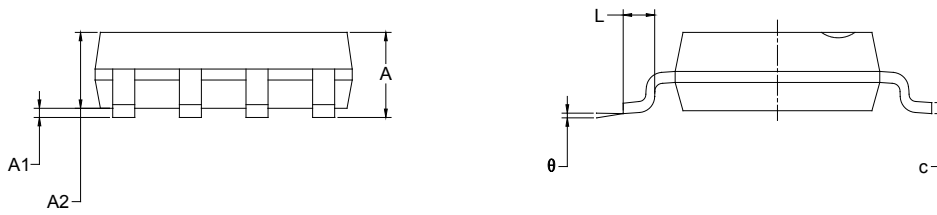
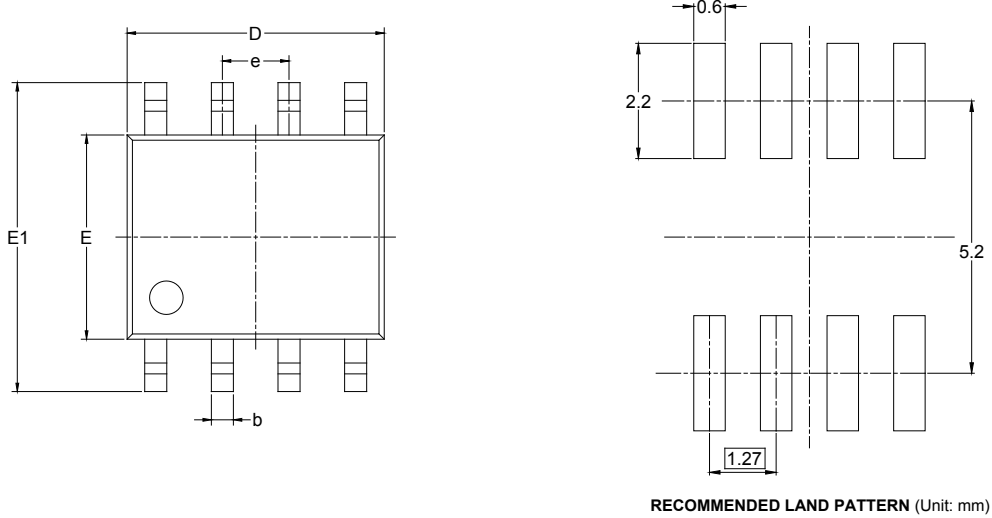

Symbol	Dimensions In Millimeters		Dimensions In Inches	
	MIN	MAX	MIN	MAX
A	1.350	1.750	0.053	0.069
A1	0.100	0.250	0.004	0.010
A2	1.350	1.550	0.053	0.061
b	0.330	0.510	0.013	0.020
c	0.170	0.250	0.006	0.010
D	4.700	5.100	0.185	0.200
E	3.800	4.000	0.150	0.157
E1	5.800	6.200	0.228	0.244
e	1.27 BSC		0.050 BSC	
L	0.400	1.270	0.016	0.050
θ	0°	8°	0°	8°

PACKAGE INFORMATION

TAPE AND REEL INFORMATION

REEL DIMENSIONS



TAPE DIMENSIONS



NOTE: The picture is only for reference. Please make the object as the standard.

KEY PARAMETER LIST OF TAPE AND REEL

Package Type	Reel Diameter	Reel Width W1 (mm)	A0 (mm)	B0 (mm)	K0 (mm)	P0 (mm)	P1 (mm)	P2 (mm)	W (mm)	Pin1 Quadrant
SOT-23-5	7"	9.5	3.20	3.20	1.40	4.0	4.0	2.0	8.0	Q3
SOT-23-6	7"	9.5	3.17	3.23	1.37	4.0	4.0	2.0	8.0	Q3
MSOP-8	13"	12.4	5.20	3.30	1.50	4.0	8.0	2.0	12.0	Q1
SOIC-8	13"	12.4	6.40	5.40	2.10	4.0	8.0	2.0	12.0	Q1

DD0001

PACKAGE INFORMATION

CARTON BOX DIMENSIONS



NOTE: The picture is only for reference. Please make the object as the standard.

KEY PARAMETER LIST OF CARTON BOX

Reel Type	Length (mm)	Width (mm)	Height (mm)	Pizza/Carton
7" (Option)	368	227	224	8
7"	442	410	224	18
13"	386	280	370	5

DD0002