

WS2 SERIES SNAP ACTION SWITCH

ANTI-VANDAL SWITCHES
 DETECTOR SWITCHES
 DIP SWITCHES
 KEYLOCK SWITCHES
 NAVIGATION SWITCHES
 PUSHBUTTON SWITCHES
 ROCKER SWITCHES
 ROTARY SWITCHES
 SLIDE SWITCHES
SNAP ACTION SWITCHES
 TACTILE SWITCHES
 TOGGLE SWITCHES
 CAP OPTIONS

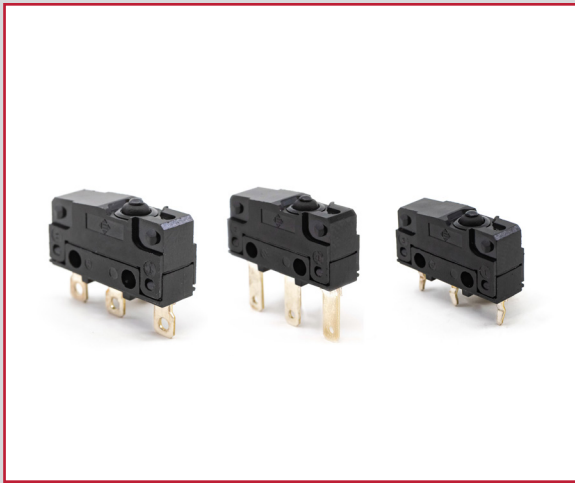

APPLICATIONS / MARKETS



RoHS

SPECIFICATIONS

Contact Rating: 01 = 2A @ 30VDC
 2A @ 250VAC
Contact Resistance: 50mΩ MAX. (Initial)
Insulation Resistance: 100MΩ MIN. @ 500VDC
Dielectric Strength: 500VAC for 1 minute
Electrical Life: 100,000 Cycles MIN.
Mechanical Life: 500,000 Cycles MIN.
Operating Temperature: -25°C to 85°C
Operating Force: 183 gf MAX.
Circuit: SPDT
Moisture Protection: IP67
Agency Approvals: cURus

FEATURES & BENEFITS

- Multiple termination options
- Long cycle life
- IP67 rated
- UL Certified

PART NUMBER CONFIGURATOR

Series	Operating Temperature	Current Rating	Actuator	Operating Force	Termination	Circuit
WS2	085 - 85°C	01 - 2A @ 30VDC 2A @ 250VAC	00 - Pin Plunger	F183 - 183 gf	S1 - Solder Lug C1 - 0.110" Quick Connect P1 - PCB Pin	A - SPDT

Specifications subject to change without notice 8.3.2022



E-SWITCH®

www.e-switch.com

800.867.2717

1

WS2 SERIES SNAP ACTION SWITCH

BODY DIMENSIONS - SOLDER LUG

O.P. (MM)	F.P. (MM)
8.10~8.70	9.30 MAX

O.P. = OPERATING POINT
F.P. = FREE-POSITION

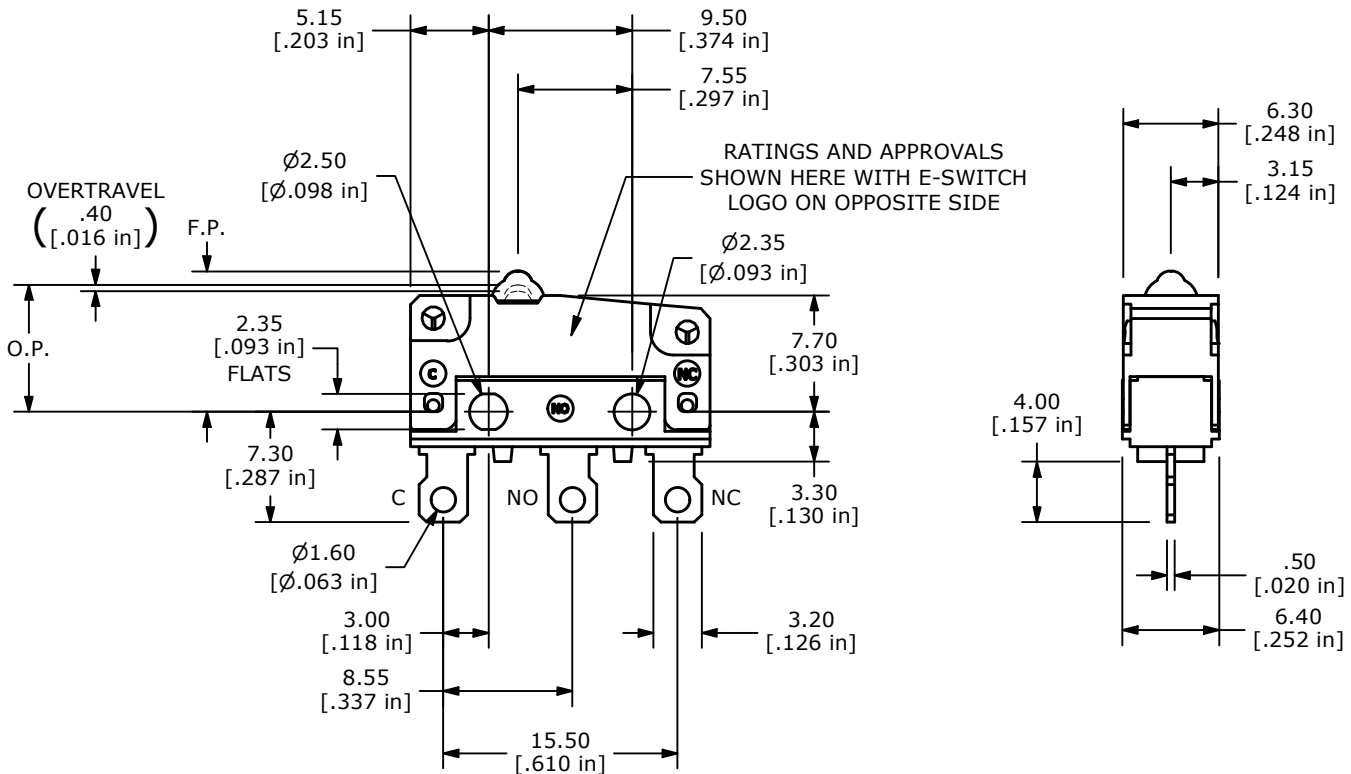
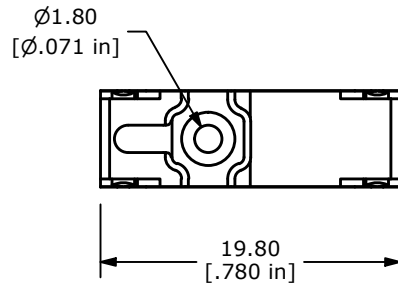
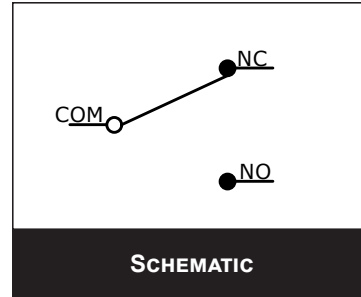

WS2 SERIES SNAP ACTION SWITCH

BODY DIMENSIONS - PCB PIN

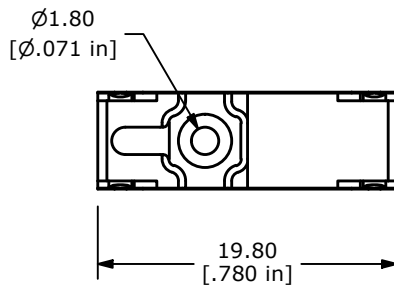
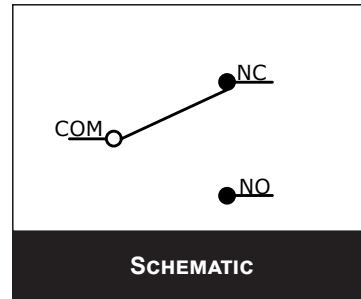
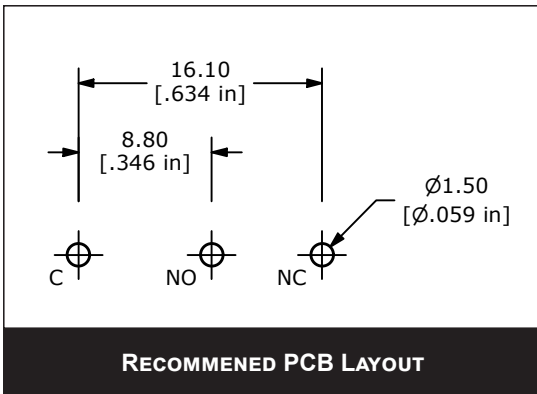

O.P. (MM)	F.P. (MM)
8.10~8.70	9.30 MAX

O.P. = OPERATING POINT
F.P. = FREE-POSITION

