

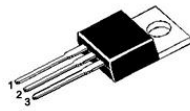

SBT20V100CT/FCT/DC/CS/CR

VERY LOW VF SCHOTTKY RECTIFIER



TO-220AB/CT

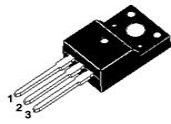

TO-220F/FCT

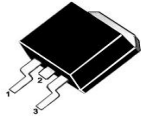

TO-263/DC



TO-252/CS



TO-262/CR

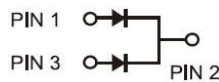

FEATURES

- Very low forward voltage
- High current capability
- High forward surge capability
- Low power losses. High efficiency
- Guarding for over voltage protection



APPLICATIONS

Low VF Schottky barrier rectifier are designed for high frequency, miniature switched mode power supplies such as adapters ,lighting and on-board DC/DC conerters

Primary Characteristic

I_O	2*10A
V_{RRM}	100V
I_{FSM}	280A
V_F	0.62V
$T_{j,max}$	150°C

MECHANICAL DATA

- **Case:** Molded plastic
- **Polarity:** As marked
- **Mounting Position:** Any
- **Molded Plastic:** UL Flammability Classification Rating 94V-0
- Lead free in compliance with EU RoHS 2011/65/EU directive
- Solder bath temperature 275°C maximum,10s per JESD 22-B106

Maximum Ratings (Per Leg) at Ta=25°C unless otherwise specified

Characteristics	Symbol	Value	Unit
Maximum Repetitive Peak Reverse Voltage	V_{RRM}	100	V
Working Peak Reverse Voltage	V_{RWM}	100	V
Maximum DC Blocking Voltage	V_{DC}	100	V
Maximum Average Forward Rectified Current	Per Leg	10	A
	Total	20	
Peak Forward Surge Current,8.3 ms Single Half Sine-wave Superimposed on Rated Load (JEDEC method)	I_{FSM}	280	A
Operating Temperature Range	T_J	-50 to +150	°C
Storage Temperature Range	T_{STG}	-50 to +150	°C
Typical Thermal Resistance (Note1)	$R_{\theta_{JC}}$	2	°C/W
TO-220AB,TO-263,TO-252,TO-262 TO-220F			

Note1: Thermal resistance from Junction to case per leg mounted on heatsink.

Electrical Characteristics (Per Leg) unless otherwise specified

Characteristics	Symbol	Value	Unit
Forward Voltage Drop(Note2)		Typ.	Max.
at $I_F=3A$	V_F	TA=25°C	-
		TA=125°C	-
at $I_F=5A$	V_F	TA=25°C	0.58
		TA=125°C	-
at $I_F=10A$	V_F	TA=25°C	0.70
		TA=125°C	-
Maximum Reverse Current at $V_R=100V$	I_R	TA=25°C	50
		TA=125°C	-
		5	μA
		4	mA

Note2:Pulse test: 300 μs pulse width, 1 % duty cycle



RATINGS AND CHARACTERISTIC CURVES

FIG. 1 MAXIMUM FORWARD CURRENT DERATING CURVE

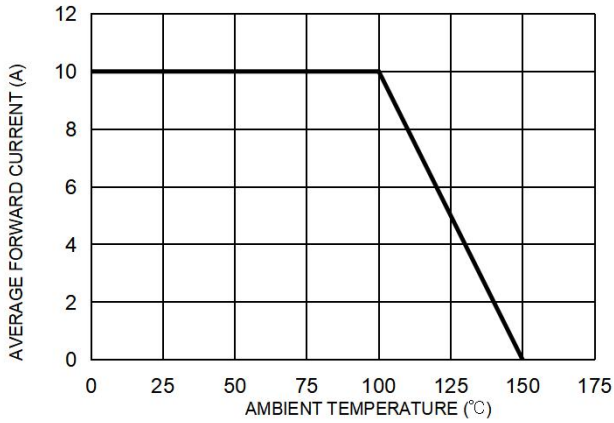

FIG. 2 MAXIMUM NON-REPETITIVE FORWARD SURGE CURRENT PER LEG

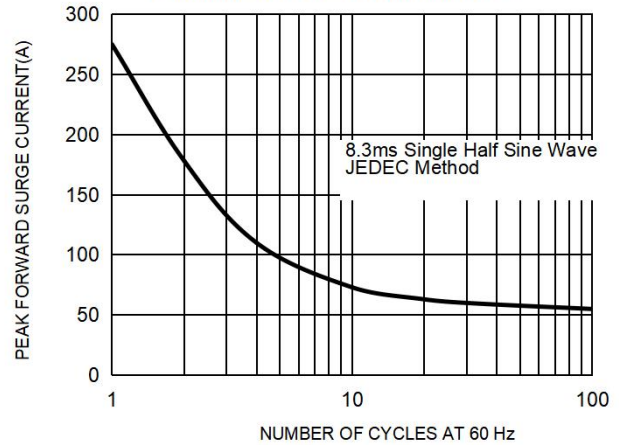

FIG. 3 TYPICAL FORWARD CHARACTERISTICS PER LEG

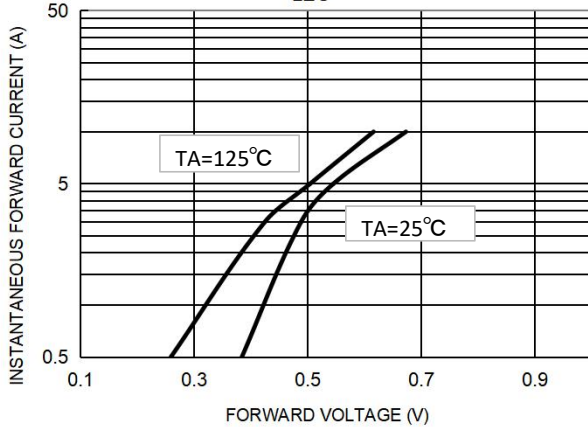
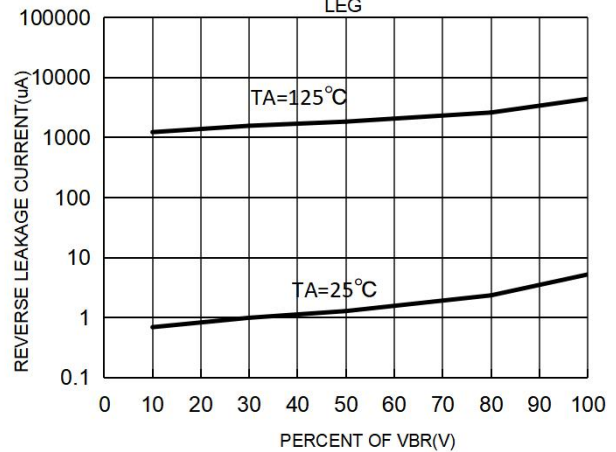

FIG. 4 TYPICAL REVERSE CHARACTERISTICS PER LEG





Package Outline Dimensions millimeters

TO-220AB

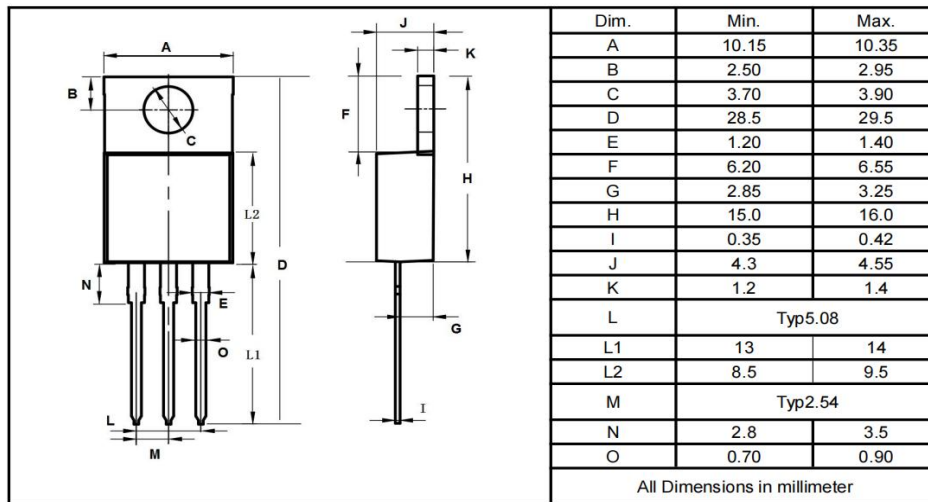

TO-220F

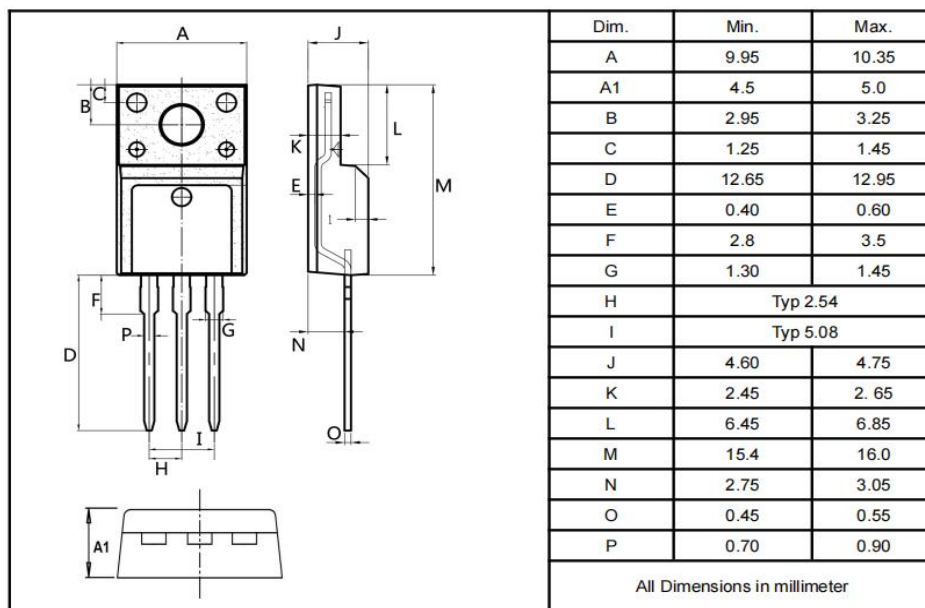

TO-263

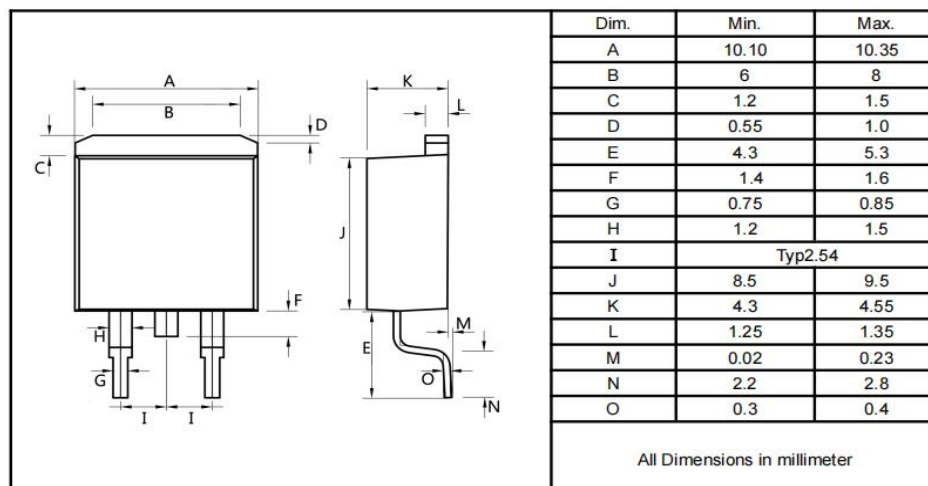



Package Outline Dimensions millimeters

TO-252

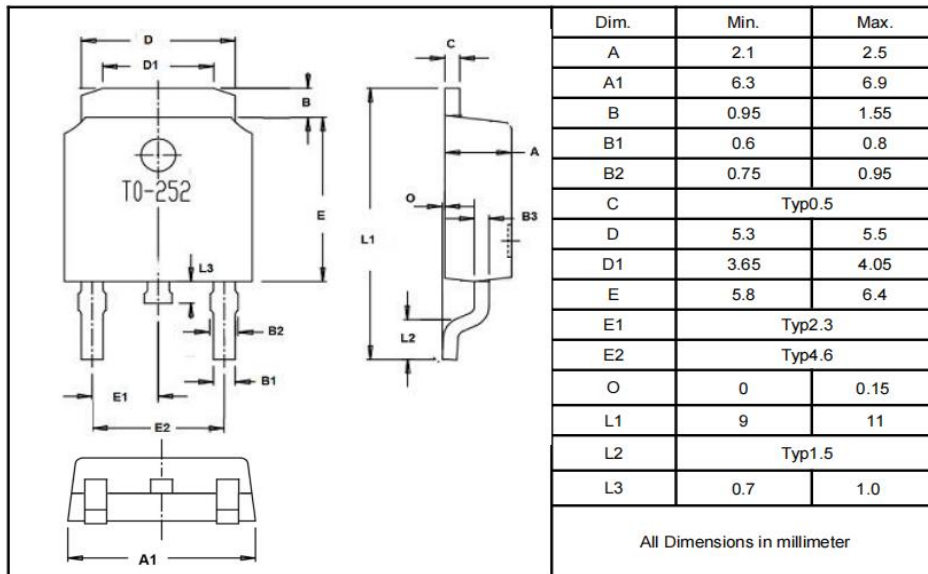

TO-262

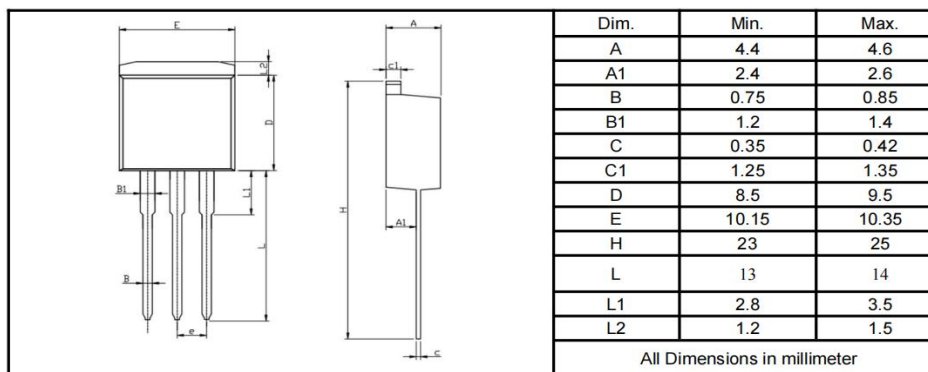



SBT20V100CT/FCT/DC/CS/CR

Marking on the body

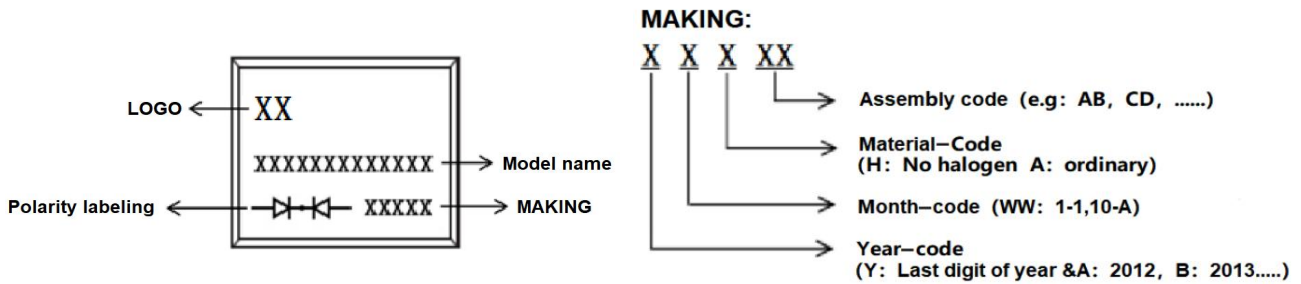

Ordering information

Part Number	Package	Unit Weight	Base Quantity	Delivery mode
SBT20V100CT	TO-220AB	0.07oz(1.96g)	50 pcs / tube	1000pcs/box 5000pcs/carton
SBT20V100FCT	TO-220F	0.06oz(1.74g)	50 pcs / tube	1000pcs/box 5000pcs/carton
SBT20V100DC	TO-263	0.04oz(1.16g)	50 pcs / tube	1000pcs/box 5000pcs/carton
SBT20V100DC-R	TO-263	0.04oz(1.16g)	800 pcs / reel	1600pcs/box 8000pcs/carton
SBT20V100CS	TO-252	0.011oz(0.32g)	2500 pcs / reel	5000pcs/box 25000pcs/carton
SBT20V100CR	TO-262	0.04oz(1.16g)	50 pcs / tube	1000pcs/box 5000pcs/carton

Note: For Halogen Free molding compound, add "H" suffix to part number above.

packing instruction

PKG	最小包装	内盒	外箱
TO-220AB TO-220F TO-263 TO-262			
	50pcs/管	1000pcs/盒	5000pcs/箱
TO-263-R			
	800pcs/盘	1600pcs/盒	8000pcs/箱
TO-252			
	2500pcs/盘	5000pcs/盒	25000pcs/箱

Notice

- All product, product specifications and data are subject to change without notice to improve. The right to explain is owned by LINGXUN electronics company.
- Confirm that operation temperature is within the specified range described in the product specification. Avoid applying power exceeding normal rated power; exceeding the power rating under steady-state loading condition may negatively affect product performance and reliability.
- LINGXUN electronics shall not be in any way responsible or liable for failure induced under deviant condition from what is defined in this document.