

## ANGELA-S-B

~10° spot beam compatible with BJB and B+W connectors

### SPECIFICATION:

Dimensions	Ø 119.5 mm
Height	74.5 mm
Fastening	socket
ROHS compliant	yes ⓘ



### MATERIALS:

Component	Type	Material	Colour	Finish	Coating
ANGELA-S-B	Reflector	PC	metal		HMDS

### ORDERING INFORMATION:

Component	Qty in box	MOQ	MPQ	Box weight (kg)
F13662_ANGELA-S-B » Box size: 398 x 298 x 265 mm	180	90	45	8.6

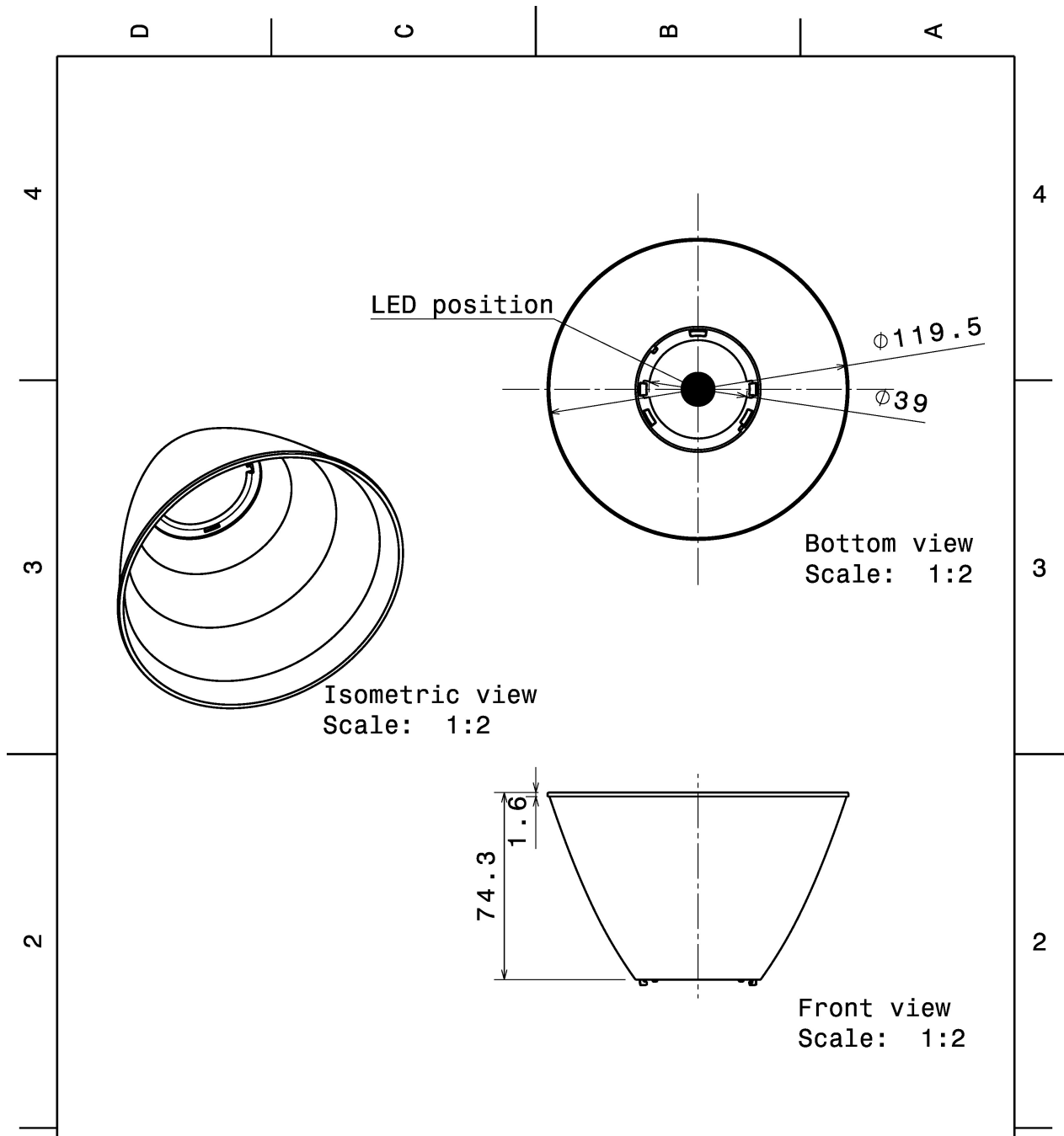

Tolerances if not otherwise shown  
According to DIN ISO 2768-1  
Linear measures:  
Up to 30mm class F, otherwise class M.  
According to DIN ISO 2768-2  
Form and position: class K

**LEDiL** Ledil Oy  
Salorankatu 10  
FIN 24240 SALO  
Finland

THIRD ANGLE PROJECTION:

DRAWING TITLE  
**ANGELA - X - B**

This drawing is the property of LEDiL Oy. It may not be reproduced, copied or communicated without a written agreement with LEDiL Oy."

SIZE	PART NUMBER	
<b>A4</b>	F13662_ANGELA-S-B	F13664_ANGELA-W-B
	F13663_ANGELA-M-B	F13841_ANGELA-XW-B

SCALE	1:2	WEIGHT	-	SHEET	1/1
-------	-----	--------	---	-------	-----

See also our general installation guide: [www.ledil.com/installation\\_guide](http://www.ledil.com/installation_guide)

#### OPTICAL RESULTS (MEASURED):

bridgelux

LED BXRA ES Rectangle  
 FWHM / FWTM 8.0° / 16.0°  
 Efficiency 94 %  
 Peak intensity 20.7 cd/lm  
 LEDs/each optic 1  
 Light colour/type White  
 Required components:  
 BJB: 47.319.2040

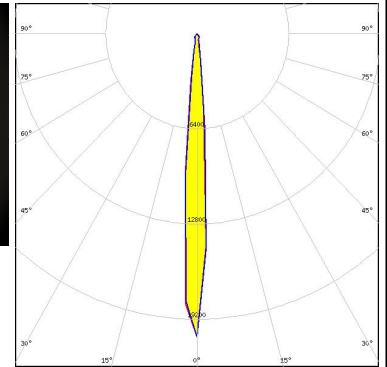
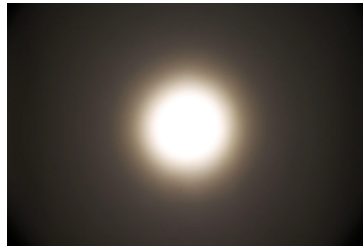

Light distribution files

bridgelux

LED V15 Gen6  
 FWHM / FWTM 11.0° / 20.0°  
 Efficiency 89 %  
 Peak intensity 13 cd/lm  
 LEDs/each optic 1  
 Light colour/type White  
 Required components:  
 BJB: 47.319.2224

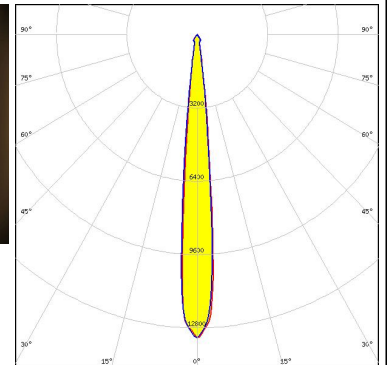

Light distribution files

bridgelux

LED V15 Gen6  
 FWHM / FWTM 11.0° / 25.0°  
 Efficiency 86 %  
 Peak intensity 9.9 cd/lm  
 LEDs/each optic 1  
 Light colour/type White  
 Required components:  
 F13671\_ANGE-RZ-LENS  
 BJB: 47.319.2274

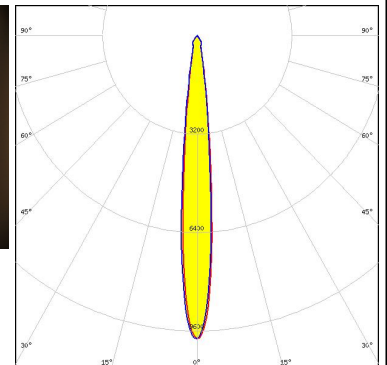

Light distribution files

### OPTICAL RESULTS (MEASURED):



**LED** V18 Gen6  
**FWHM / FWTM** 13.0° / 28.0°  
**Efficiency** 86 %  
**Peak intensity** 8.2 cd/lm  
**LEDs/each optic** 1  
**Light colour/type** White  
**Required components:**  
 F13671\_ANGE-RZ-LENS  
 BJB: 47.319.2274

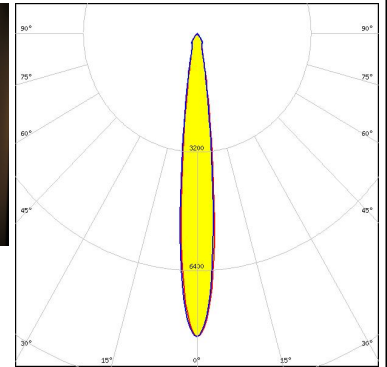

Light distribution files



**LED** V18 Gen6  
**FWHM / FWTM** 12.0° / 23.0°  
**Efficiency** 89 %  
**Peak intensity** 10 cd/lm  
**LEDs/each optic** 1  
**Light colour/type** White  
**Required components:**  
 BJB: 47.319.2274

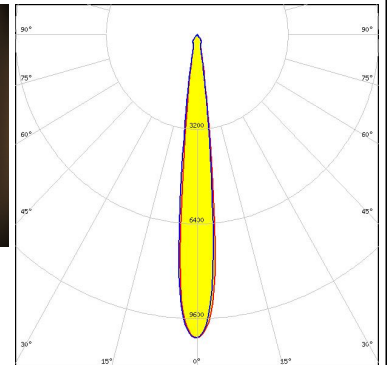

Light distribution files



**LED** V18 Gen7  
**FWHM / FWTM** 12.0° / 24.0°  
**Efficiency** 91 %  
**Peak intensity** 10.2 cd/lm  
**LEDs/each optic** 1  
**Light colour/type** White  
**Required components:**  
 BJB: 47.319.2350

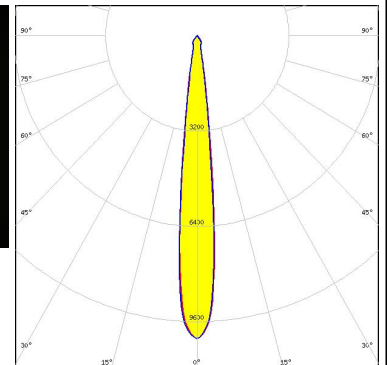

Light distribution files



#### OPTICAL RESULTS (MEASURED):



LED V22 Gen6  
 FWHM / FWTM 15.0° / 30.0°  
 Efficiency 88 %  
 Peak intensity 7 cd/lm  
 LEDs/each optic 1  
 Light colour/type White  
 Required components:  
 A.A.G. STUCCHI: 8102-G2

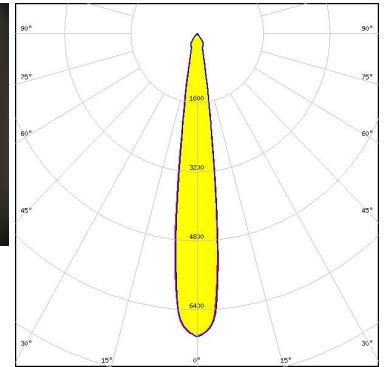

Light distribution files



LED V22 Gen6  
 FWHM / FWTM 15.0° / 35.0°  
 Efficiency 84 %  
 Peak intensity 5.8 cd/lm  
 LEDs/each optic 1  
 Light colour/type White  
 Required components:  
 F13671\_ANGE-RZ-LENS  
 A.A.G. STUCCHI: 8102-G2

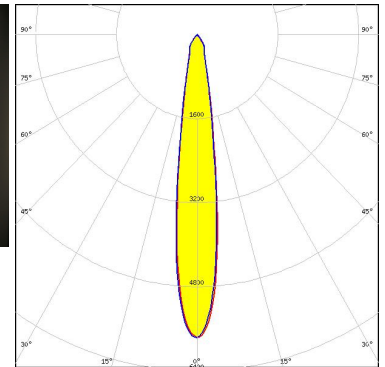

Light distribution files

## CITIZEN

LED CLL03x/CLU03x  
 FWHM / FWTM 10.0° / 23.0°  
 Efficiency 86 %  
 Peak intensity 10.8 cd/lm  
 LEDs/each optic 1  
 Light colour/type White  
 Required components:  
 F13671\_ANGE-RZ-LENS  
 A.A.G. STUCCHI: 8101-G2

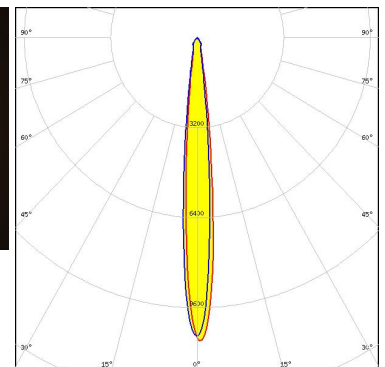
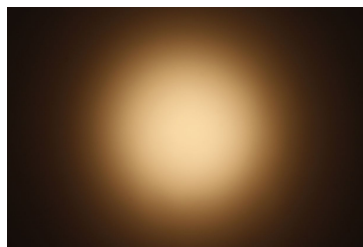

Light distribution files

#### OPTICAL RESULTS (MEASURED):

### CITIZEN

LED CLL03x/CLU03x  
 FWHM / FWTM 10.0° / 18.0°  
 Efficiency 93 %  
 Peak intensity 15.4 cd/lm  
 LEDs/each optic 1  
 Light colour/type White  
 Required components:  
 A.A.G. STUCCHI: 8101-G2

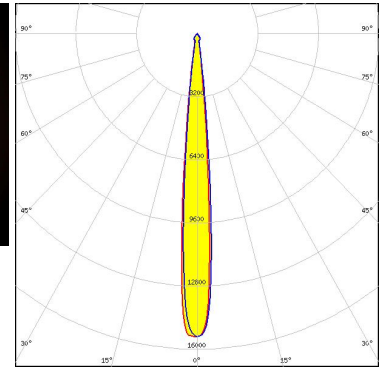
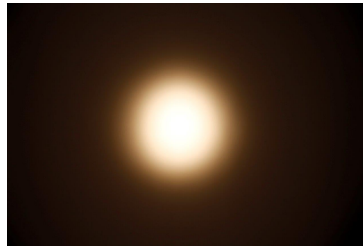

Light distribution files

### CITIZEN

LED CLL03x/CLU03x  
 FWHM / FWTM 9.0° / 17.0°  
 Efficiency 94 %  
 Peak intensity 18.3 cd/lm  
 LEDs/each optic 1  
 Light colour/type White  
 Required components:  
 BJB: 47.319.2021

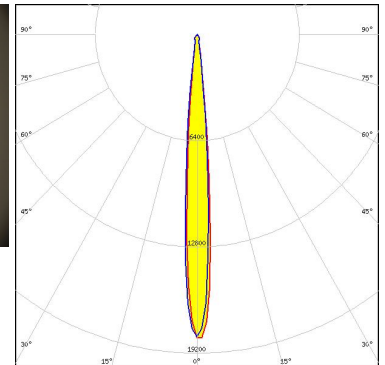

Light distribution files

### CITIZEN

LED CLL04x/CLU04x  
 FWHM / FWTM 15.0° / 30.0°  
 Efficiency 92 %  
 Peak intensity 6.9 cd/lm  
 LEDs/each optic 1  
 Light colour/type White  
 Required components:  
 A.A.G. STUCCHI: 8102-G2

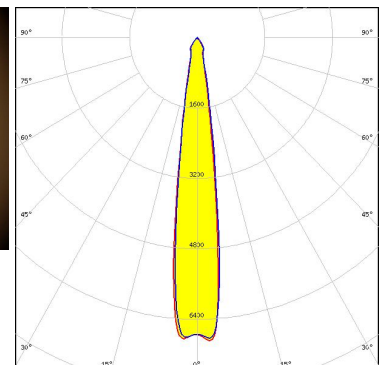
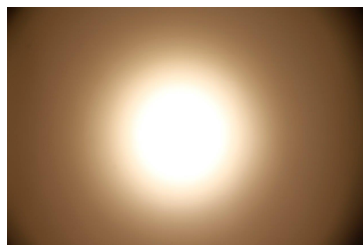

Light distribution files

#### OPTICAL RESULTS (MEASURED):

### CITIZEN

LED CLL04x/CLU04x  
 FWHM / FWTM 15.0° / 29.0°  
 Efficiency 92 %  
 Peak intensity 7.3 cd/lm  
 LEDs/each optic 1  
 Light colour/type White  
 Required components:  
 BJB: 47.319.2030

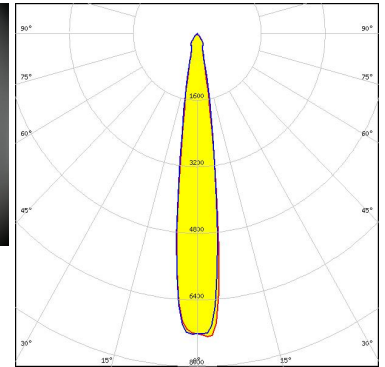

Light distribution files

### CITIZEN

LED CLL04x/CLU04x  
 FWHM / FWTM 15.0° / 35.0°  
 Efficiency 86 %  
 Peak intensity 5.9 cd/lm  
 LEDs/each optic 1  
 Light colour/type White  
 Required components:  
 F13671\_ANGE-RZ-LENS  
 A.A.G. STUCCHI: 8102-G2

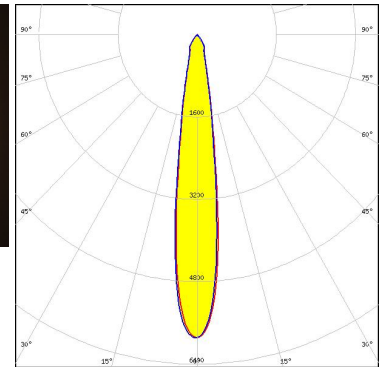
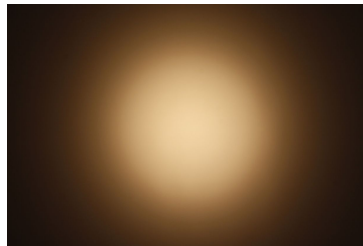

Light distribution files

### CITIZEN

LED CLU720/721/723  
 FWHM / FWTM 7.0° / 14.0°  
 Efficiency 94 %  
 Peak intensity 25 cd/lm  
 LEDs/each optic 1  
 Light colour/type White  
 Required components:  
 A.A.G. STUCCHI: 8101-G2

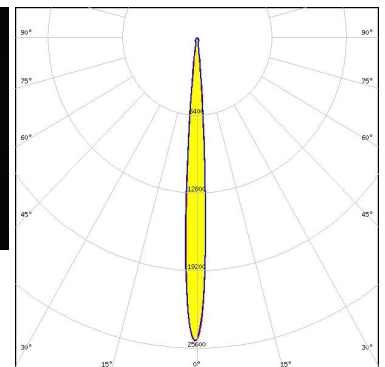
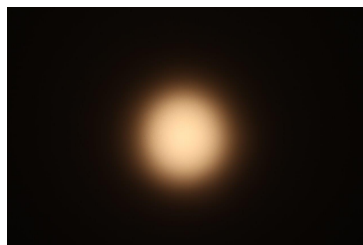

Light distribution files

#### OPTICAL RESULTS (MEASURED):

### CITIZEN

LED CLU720/721/723  
 FWHM / FWTM 7.0° / 14.0°  
 Efficiency 94 %  
 Peak intensity 25.3 cd/lm  
 LEDs/each optic 1  
 Light colour/type White  
 Required components:  
 BJB: 47.319.2021

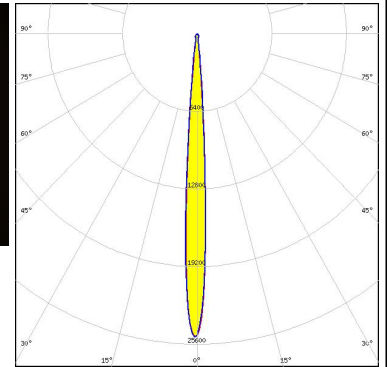

Light distribution files



LED CXA/B 25xx  
 FWHM / FWTM 13.0° / 25.0°  
 Efficiency 89 %  
 Peak intensity 9.3 cd/lm  
 LEDs/each optic 1  
 Light colour/type White  
 Required components:  
 BJB: 47.319.2141

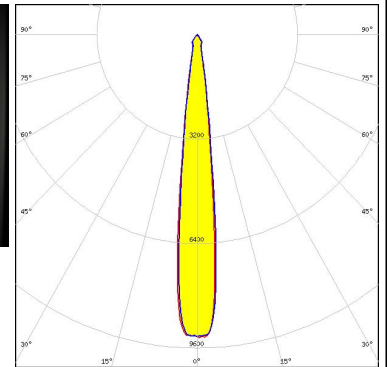

Light distribution files



LED CXA/B 25xx  
 FWHM / FWTM 11.0° / 22.0°  
 Efficiency 92 %  
 Peak intensity 11.6 cd/lm  
 LEDs/each optic 1  
 Light colour/type White  
 Required components:  
 A.A.G. STUCCHI: 8401-G2

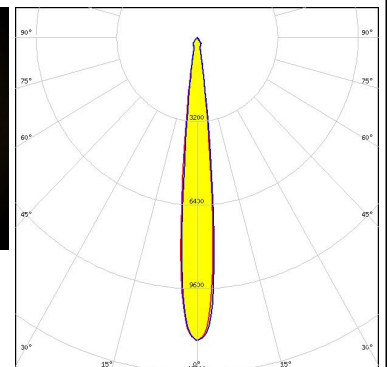
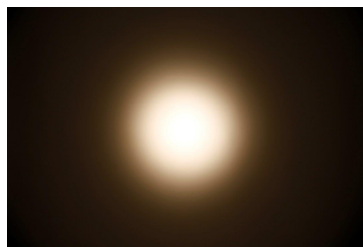

Light distribution files

#### OPTICAL RESULTS (MEASURED):



LED CXA/B 25xx  
 FWHM / FWTM 13.0° / 30.0°  
 Efficiency 86 %  
 Peak intensity 7.5 cd/lm  
 LEDs/each optic 1  
 Light colour/type White  
 Required components:  
 F13671\_ANGE-RZ-LENS  
 BJB: 47.319.2141

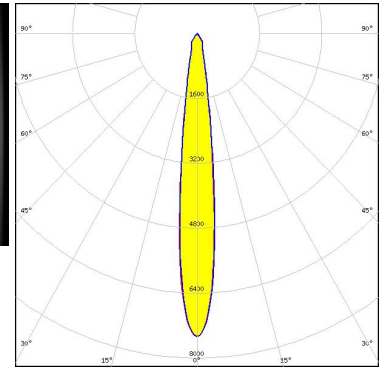

Light distribution files



LED CXA/B 30xx  
 FWHM / FWTM 15.0° / 30.0°  
 Efficiency 91 %  
 Peak intensity 7.2 cd/lm  
 LEDs/each optic 1  
 Light colour/type White  
 Required components:  
 A.A.G. STUCCHI: 8404-G2

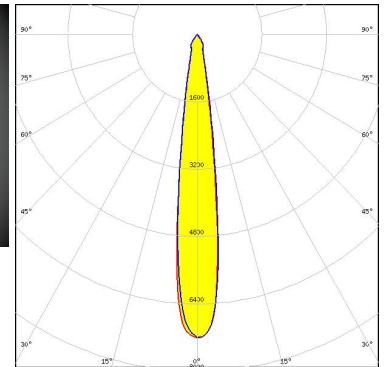
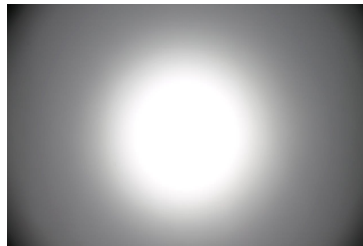

Light distribution files



LED LUXEON CoB 1204/1205  
 FWHM / FWTM 9.0° / 16.0°  
 Efficiency 93 %  
 Peak intensity 19.2 cd/lm  
 LEDs/each optic 1  
 Light colour/type White  
 Required components:  
 A.A.G. STUCCHI: 8301-G2

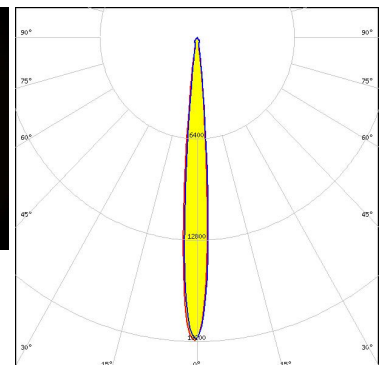
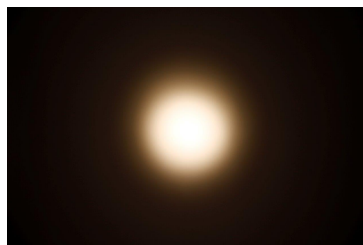

Light distribution files

#### OPTICAL RESULTS (MEASURED):



**LED** LUXEON CoB 1208  
**FWHM / FWTM** 11.0° / 24.0°  
**Efficiency** 86 %  
**Peak intensity** 10 cd/lm  
**LEDs/each optic** 1  
**Light colour/type** White  
**Required components:**  
 F13671\_ANGE-RZ-LENS  
 A.A.G. STUCCHI: 8301-G2

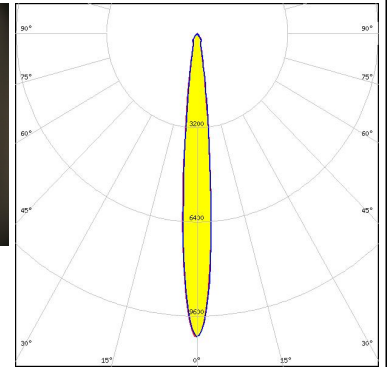

Light distribution files



**LED** LUXEON CoB 1208  
**FWHM / FWTM** 10.0° / 19.0°  
**Efficiency** 94 %  
**Peak intensity** 14.8 cd/lm  
**LEDs/each optic** 1  
**Light colour/type** White  
**Required components:**  
 A.A.G. STUCCHI: 8301-G2

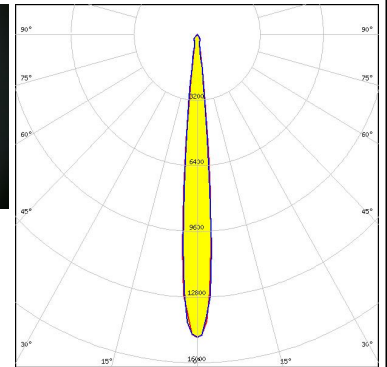

Light distribution files



**LED** LUXEON CoB 1211  
**FWHM / FWTM** 13.0° / 25.0°  
**Efficiency** 90 %  
**Peak intensity** 9.4 cd/lm  
**LEDs/each optic** 1  
**Light colour/type** White  
**Required components:**  
 BJB: 47.319.2030

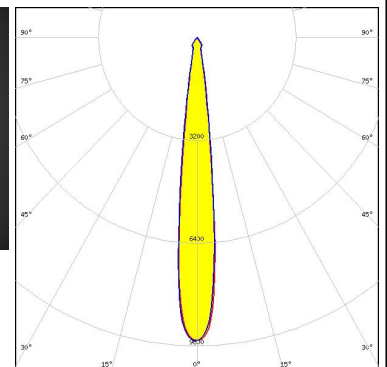

Light distribution files



### OPTICAL RESULTS (MEASURED):



LED LUXEON CoB 1211  
FWHM / FWTM 13.0° / 24.0°  
Efficiency 91 %  
Peak intensity 9.5 cd/m  
LEDs/each optic 1  
Light colour/type White  
Required components:  
A.A.G. STUCCHI: 8102-G2

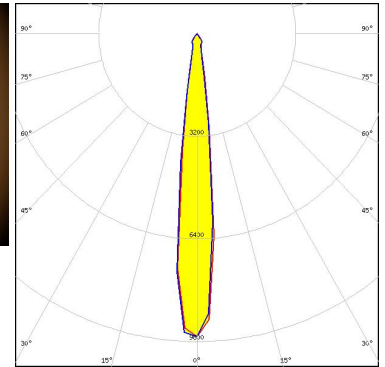

Light distribution files



LED LUXEON CoB 1213/1216/1812  
FWHM / FWTM 16.0° / 37.0°  
Efficiency 85 %  
Peak intensity 5.5 cd/m  
LEDs/each optic 1  
Light colour/type White  
Required components:  
F13671\_ANGE-RZ-LENS  
BJB: 47.319.2030

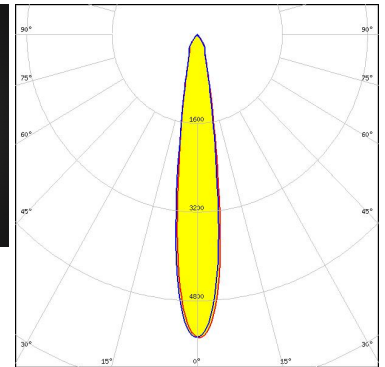
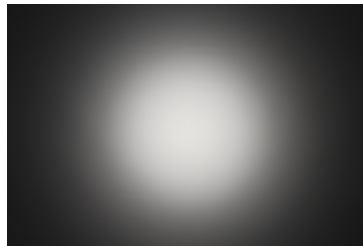

Light distribution files



LED LUXEON CoB 1213/1216/1812  
FWHM / FWTM 15.0° / 31.0°  
Efficiency 89 %  
Peak intensity 6.6 cd/m  
LEDs/each optic 1  
Light colour/type White  
Required components:  
BJB: 47.319.2030

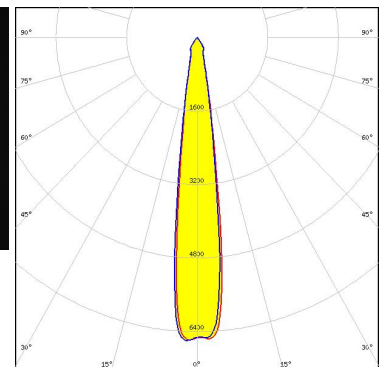

Light distribution files



#### OPTICAL RESULTS (MEASURED):

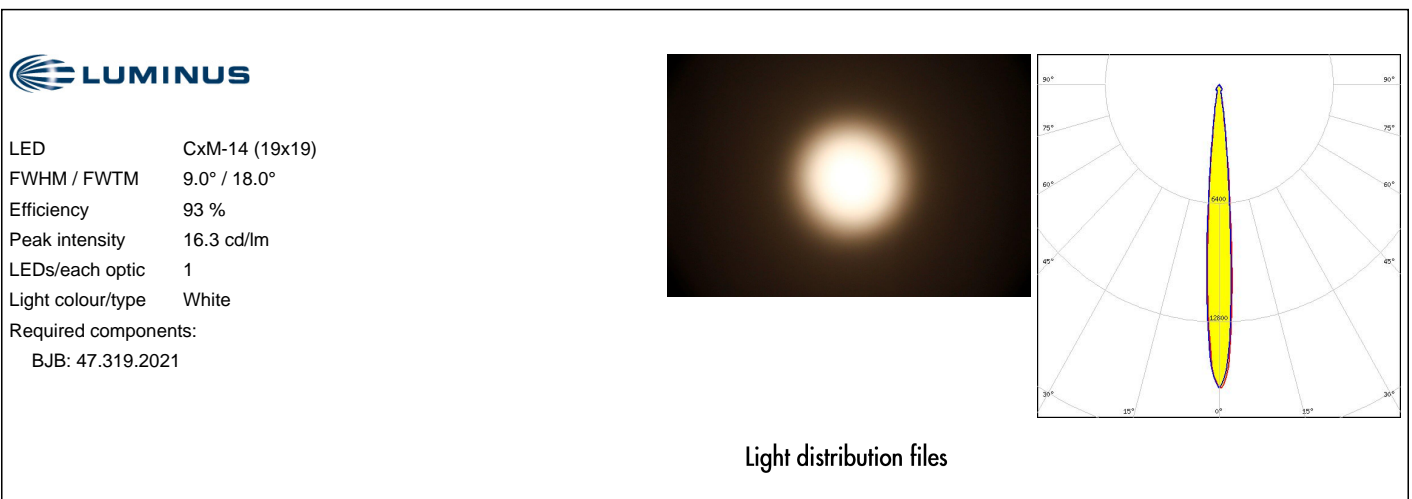
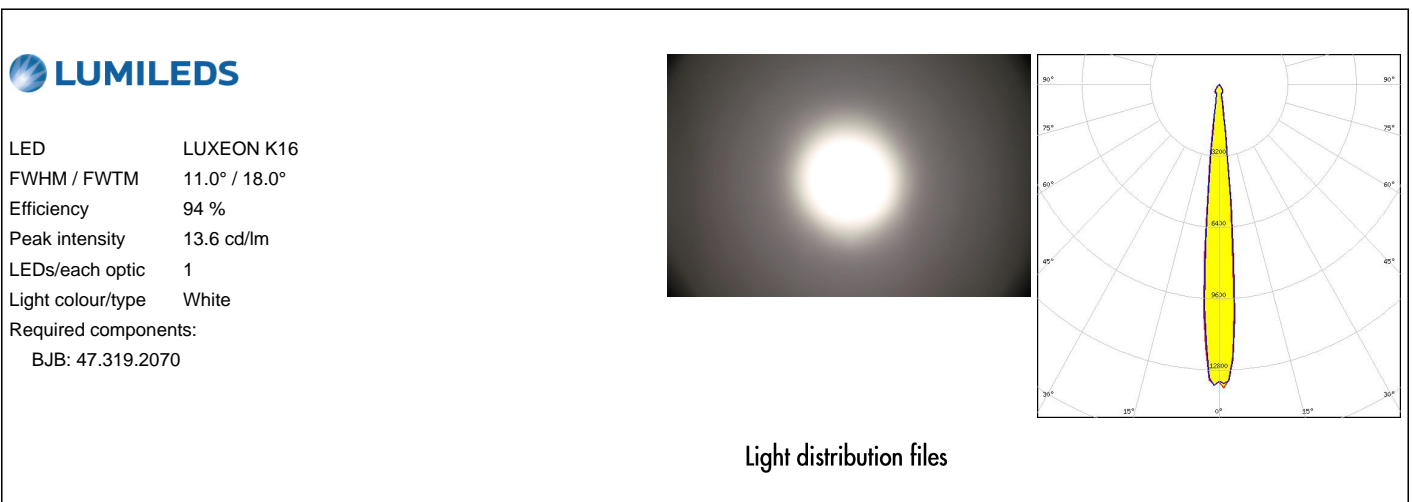
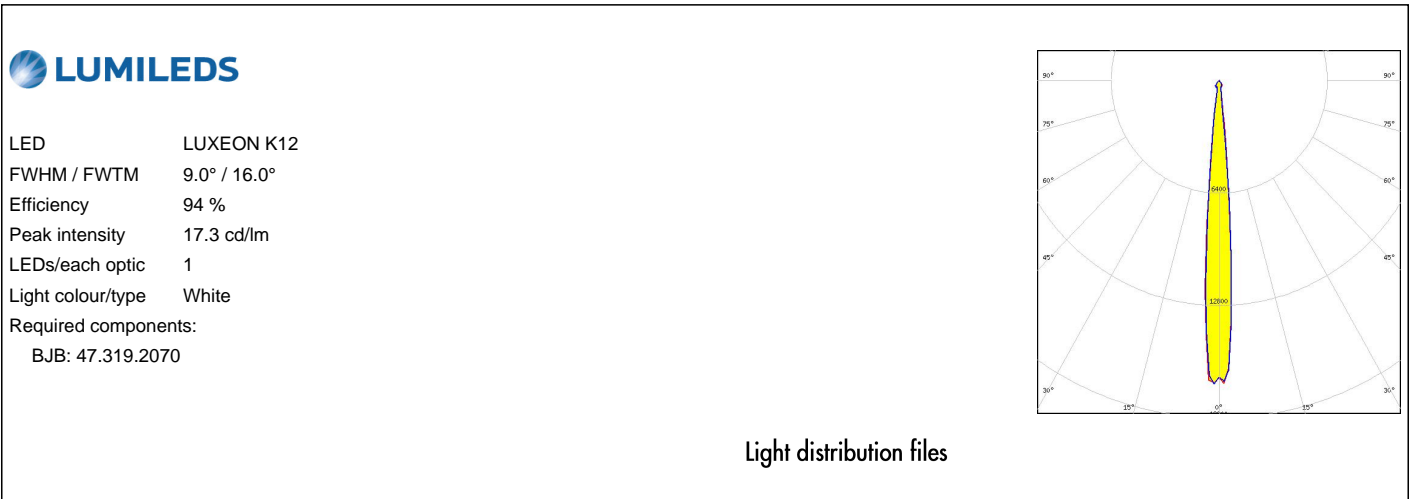

### OPTICAL RESULTS (MEASURED):

**OSRAM**  
Opto Semiconductors

LED Soleriq S13  
FWHM / FWTM 8.0° / 15.0°  
Efficiency 94 %  
Peak intensity 21.6 cd/lm  
LEDs/each optic 1  
Light colour/type White  
Required components:  
A.A.G. STUCCHI: 8502-G2

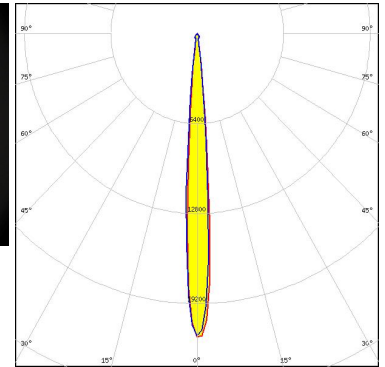

Light distribution files

**OSRAM**  
Opto Semiconductors

LED Soleriq S13 19x19  
FWHM / FWTM 8.5° / 160.0°  
Efficiency 89 %  
Peak intensity 19.7 cd/lm  
LEDs/each optic 1  
Light colour/type White  
Required components:  
BJB: 47.319.2021

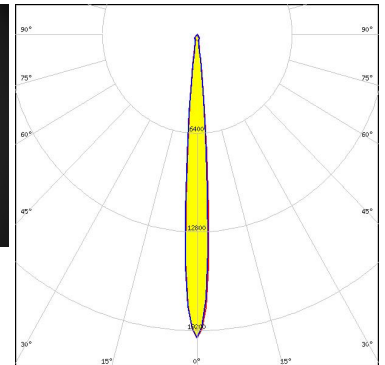

Light distribution files

**OSRAM**  
Opto Semiconductors

LED Soleriq S19  
FWHM / FWTM 11.0° / 20.0°  
Efficiency 93 %  
Peak intensity 13.1 cd/lm  
LEDs/each optic 1  
Light colour/type White  
Required components:  
BJB: 47.319.2170

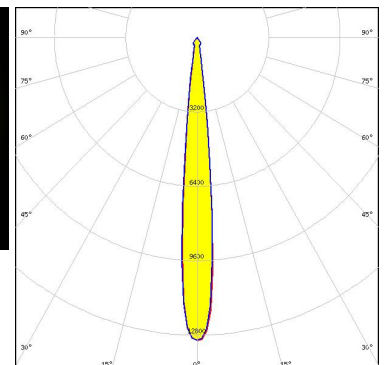
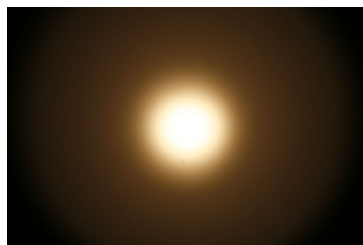

Light distribution files

#### OPTICAL RESULTS (MEASURED):

### PHILIPS

LED Fortimo SLM L19 CoB  
 FWHM / FWTM 13.0° / 25.0°  
 Efficiency 91 %  
 Peak intensity 9.3 cd/lm  
 LEDs/each optic 1  
 Light colour/type White  
 Required components:  
 BJB: 47.319.2030

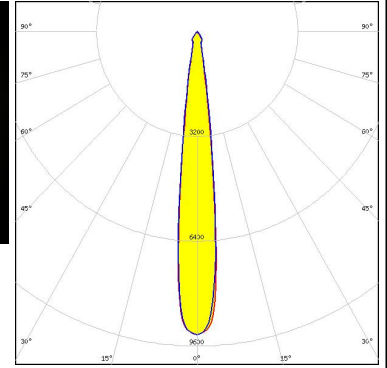
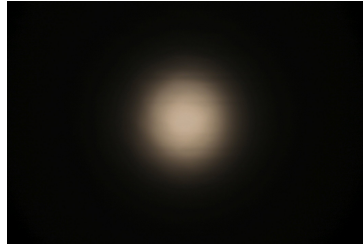

Light distribution files

### PHILIPS

LED Fortimo SLM L19 CoB  
 FWHM / FWTM 13.0° / 29.0°  
 Efficiency 86 %  
 Peak intensity 7.5 cd/lm  
 LEDs/each optic 1  
 Light colour/type White  
 Required components:  
 F13671\_ANGE-RZ-LENS  
 BJB: 47.319.2030

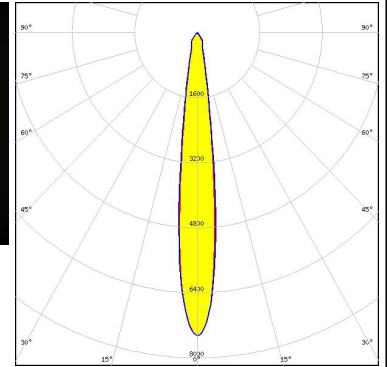

Light distribution files

### PHILIPS

LED Fortimo SLM L23 CoB  
 FWHM / FWTM 16.0° / 37.0°  
 Efficiency 86 %  
 Peak intensity 5.6 cd/lm  
 LEDs/each optic 1  
 Light colour/type White  
 Required components:  
 F13671\_ANGE-RZ-LENS  
 BJB: 47.319.2030

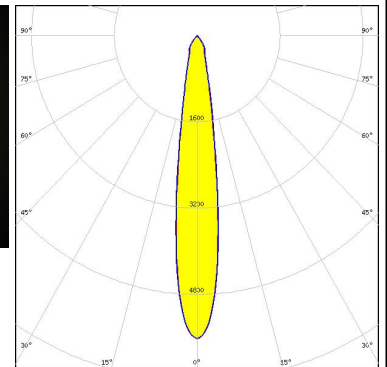
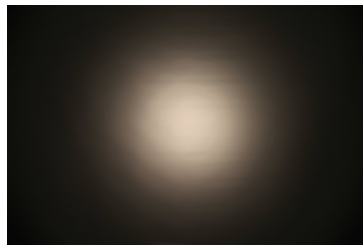

Light distribution files

#### OPTICAL RESULTS (MEASURED):

### PHILIPS

LED Fortimo SLM L23 CoB  
 FWHM / FWTM 15.0° / 32.0°  
 Efficiency 91 %  
 Peak intensity 6.7 cd/lm  
 LEDs/each optic 1  
 Light colour/type White  
 Required components:  
 BJB: 47.319.2030

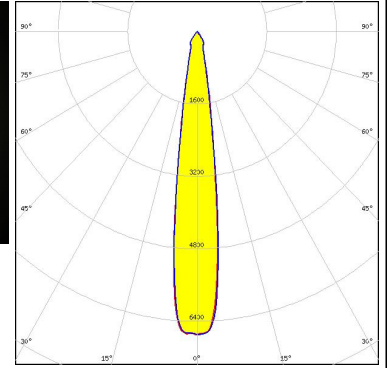

Light distribution files

### SAMSUNG

LED LC016D / LC019D / LC026D / LC033D  
 FWHM / FWTM 10.0° / 19.0°  
 Efficiency 91 %  
 Peak intensity 15.2 cd/lm  
 LEDs/each optic 1  
 Light colour/type White  
 Required components:  
 A.A.G. STUCCHI: 8101-G2

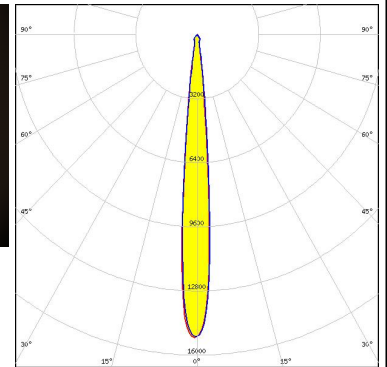

Light distribution files

### SAMSUNG

LED LC016D / LC019D / LC026D / LC033D  
 FWHM / FWTM 11.0° / 23.0°  
 Efficiency 87 %  
 Peak intensity 11 cd/lm  
 LEDs/each optic 1  
 Light colour/type White  
 Required components:  
 F13671\_ANGE-RZ-LENS  
 BJB: 47.319.2021

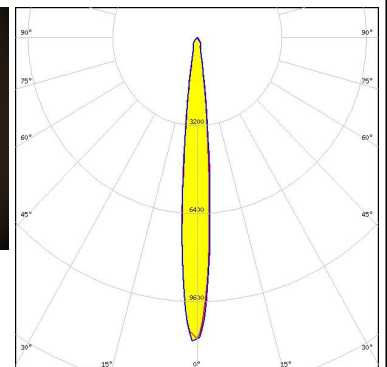

Light distribution files

#### OPTICAL RESULTS (MEASURED):

### SAMSUNG

LED LC016D / LC019D / LC026D / LC033D  
 FWHM / FWTM 10.0° / 19.0°  
 Efficiency 91 %  
 Peak intensity 15.2 cd/lm  
 LEDs/each optic 1  
 Light colour/type White  
 Required components:  
 BJB: 47.319.2021

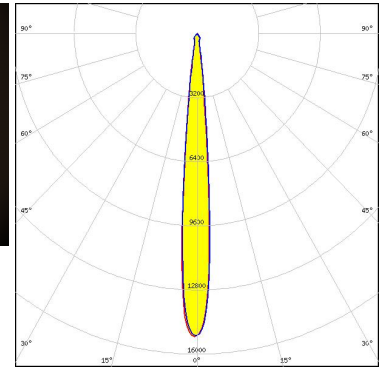

Light distribution files

### SAMSUNG

LED LC016D / LC019D / LC026D / LC033D  
 FWHM / FWTM 11.0° / 23.0°  
 Efficiency 87 %  
 Peak intensity 11 cd/lm  
 LEDs/each optic 1  
 Light colour/type White  
 Required components:  
 F13671\_ANGE-RZ-LENS  
 A.A.G. STUCCHI: 8101-G2

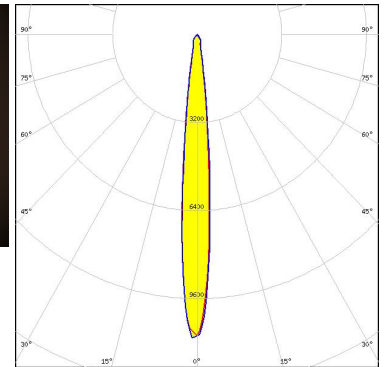

Light distribution files



LED ZC12/18  
 FWHM / FWTM 9.0° / 17.0°  
 Efficiency 93 %  
 Peak intensity 18.4 cd/lm  
 LEDs/each optic 1  
 Light colour/type White  
 Required components:  
 A.A.G. STUCCHI: 8101-G2

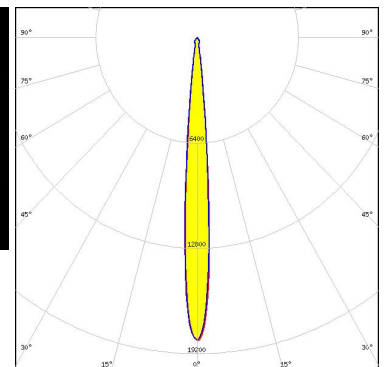
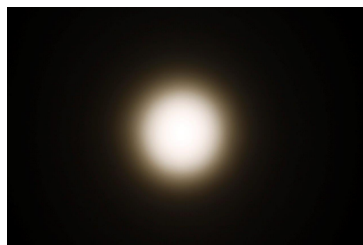

Light distribution files

### OPTICAL RESULTS (MEASURED):

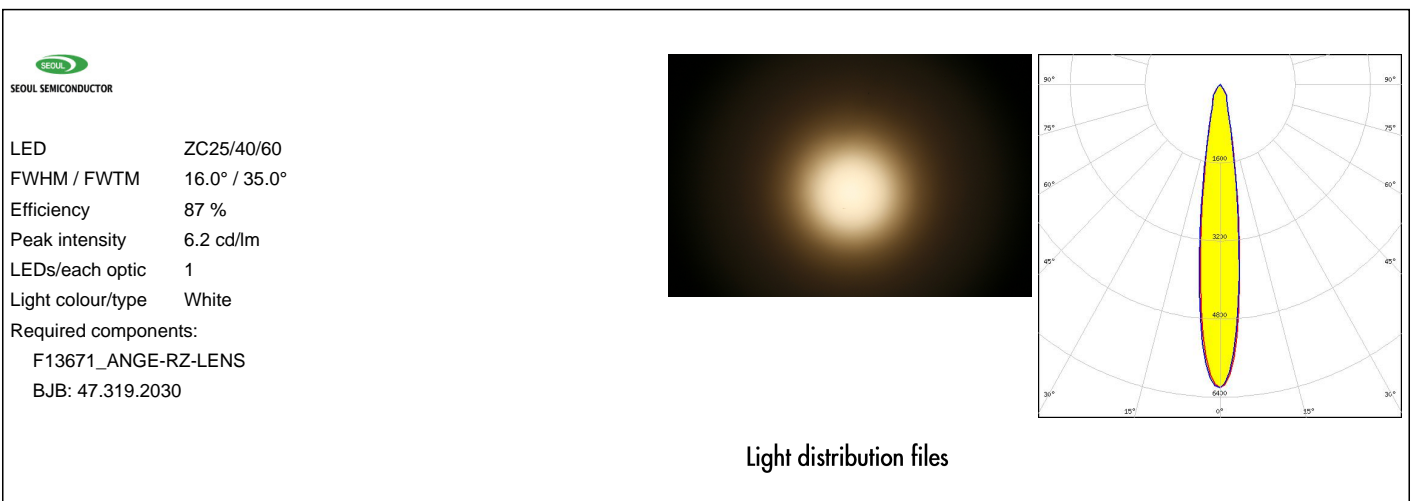
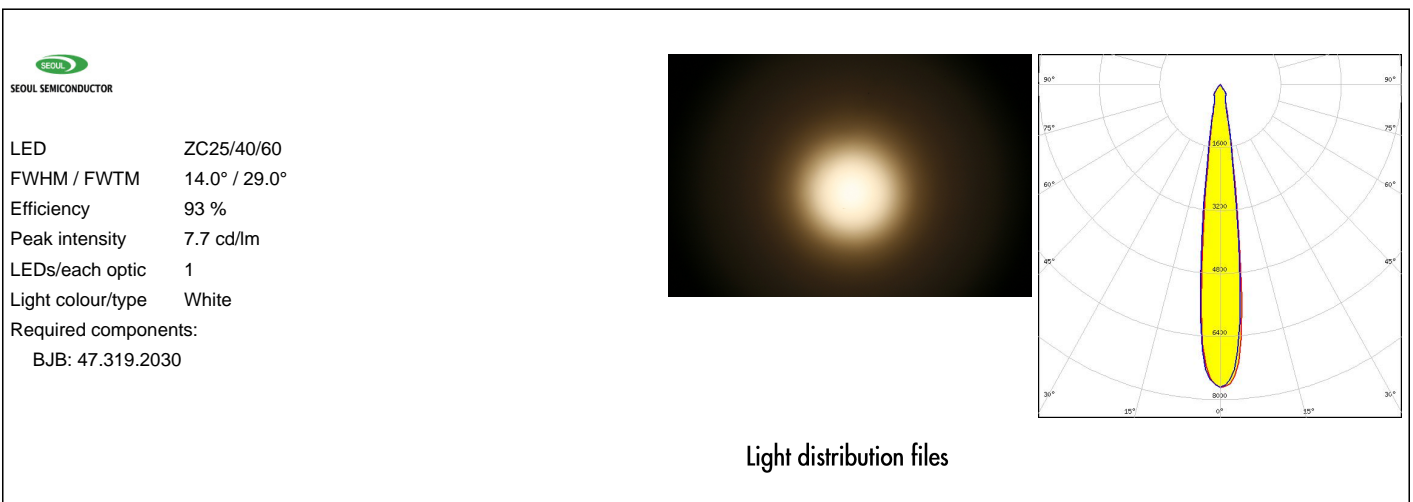
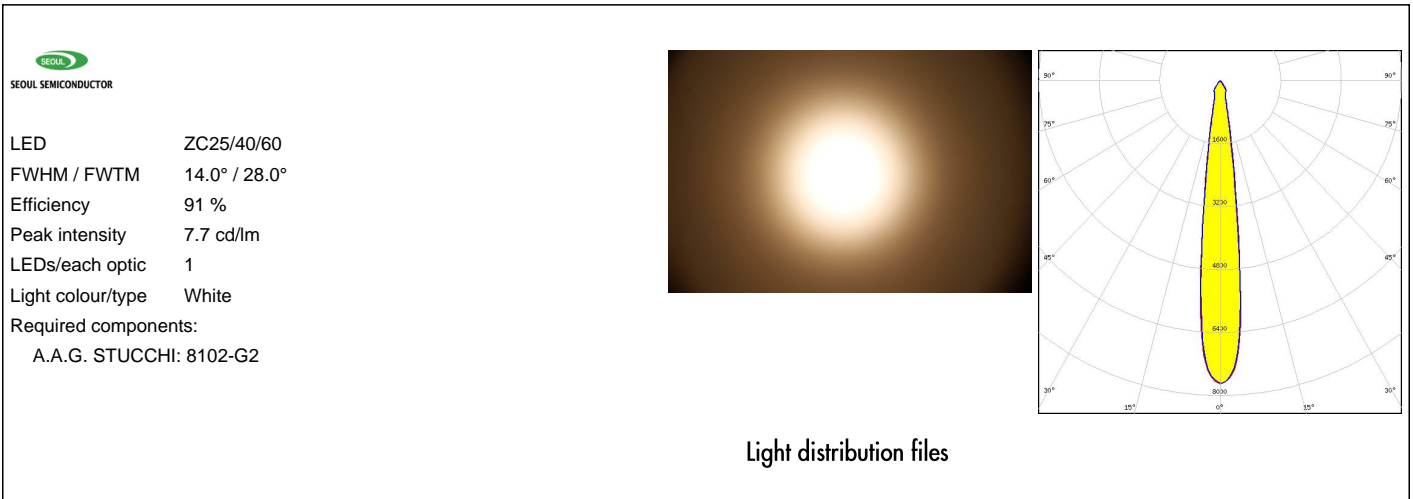



### OPTICAL RESULTS (MEASURED):

#### SHARP

LED Mega Zenigata (GW6DME)  
FWHM / FWTM 10.0° / 18.0°  
Efficiency 94 %  
Peak intensity 16.1 cd/lm  
LEDs/each optic 1  
Light colour/type White  
Required components:  
BJB: 47.319.2011

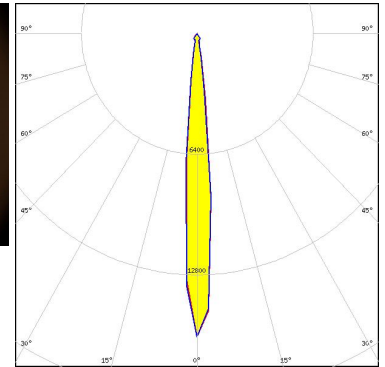

Light distribution files

#### SHARP

LED Mega Zenigata (GW6DME)  
FWHM / FWTM 10.0° / 18.0°  
Efficiency 94 %  
Peak intensity 15.5 cd/lm  
LEDs/each optic 1  
Light colour/type White  
Required components:  
A.A.G. STUCCHI: 8301-G2

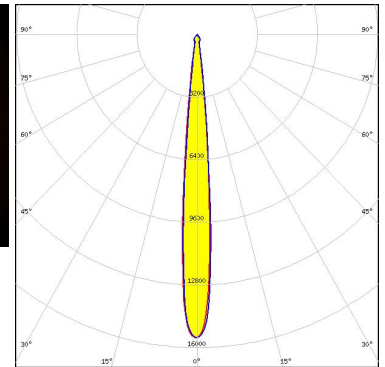
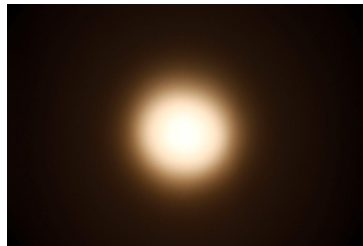

Light distribution files

#### TRIDONIC

LED SLE G7 LES17 H  
FWHM / FWTM 11.0° / 23.0°  
Efficiency 90 %  
Peak intensity 10.9 cd/lm  
LEDs/each optic 1  
Light colour/type White  
Required components:

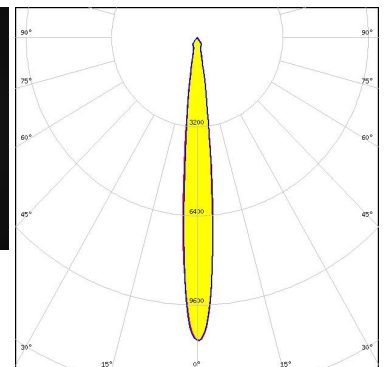
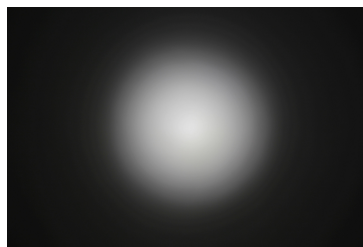

Light distribution files



#### OPTICAL RESULTS (MEASURED):

### TRIDONIC

LED SLE G7 LES21 H  
 FWHM / FWTM 14.0° / 29.0°  
 Efficiency 90 %  
 Peak intensity 7.7 cd/lm  
 LEDs/each optic 1  
 Light colour/type White  
 Required components:

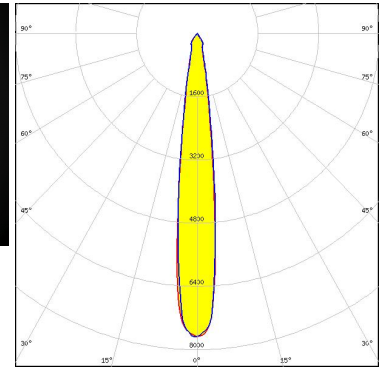

Light distribution files

### XICATO

LED XOB 14.5 mm  
 FWHM / FWTM 9.0° / 18.0°  
 Efficiency 92 %  
 Peak intensity 16.7 cd/lm  
 LEDs/each optic 1  
 Light colour/type White  
 Required components:  
 BJB: 47.319.2021

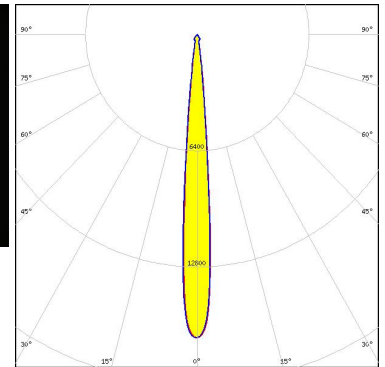

Light distribution files

### XICATO

LED XTM - 19mm LES  
 FWHM / FWTM 12.0° / 22.0°  
 Efficiency 91 %  
 Peak intensity 11 cd/lm  
 LEDs/each optic 1  
 Light colour/type White  
 Required components:  
 C15743\_XTM-ADAPTER-50-B

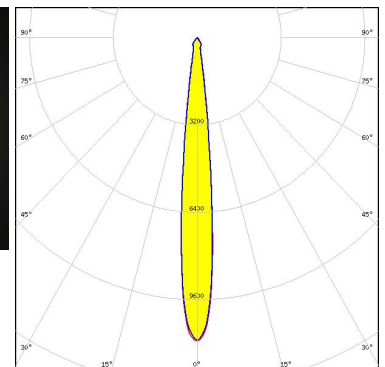
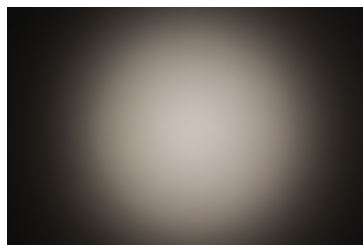

Light distribution files

### OPTICAL RESULTS (SIMULATED):

#### CITIZEN

LED CLL03x/CLU03x  
FWHM / FWTM 9.3° / 18.0°  
Efficiency 94 %  
Peak intensity 19.2 cd/lm  
LEDs/each optic 1  
Light colour/type White  
Required components:

BJB: 47.319.2021

Light distribution files

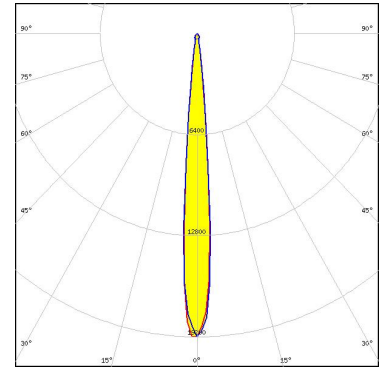

#### CITIZEN

LED CLL04x/CLU04x  
FWHM / FWTM 14.0° / 29.0°  
Efficiency 93 %  
Peak intensity 8 cd/lm  
LEDs/each optic 1  
Light colour/type White  
Required components:

BJB: 47.319.2030

Light distribution files

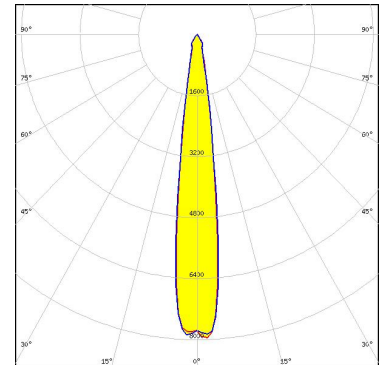

#### CITIZEN

LED CLU730/731/733  
FWHM / FWTM 8.5° / 15.0°  
Efficiency 92 %  
Peak intensity 22.2 cd/lm  
LEDs/each optic 1  
Light colour/type White  
Required components:

BJB: 47.319.2030

Light distribution files

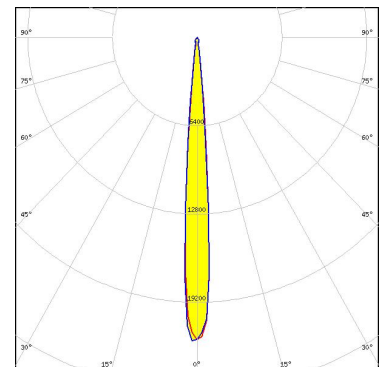

### OPTICAL RESULTS (SIMULATED):

**OSRAM**  
Opto Semiconductors

LED Soleriq S15  
FWHM / FWTM 10.0° / 18.0°  
Efficiency 90 %  
Peak intensity 14.6 cd/lm  
LEDs/each optic 1  
Light colour/type White  
Required components:

BJB: 47.319.2021

Light distribution files

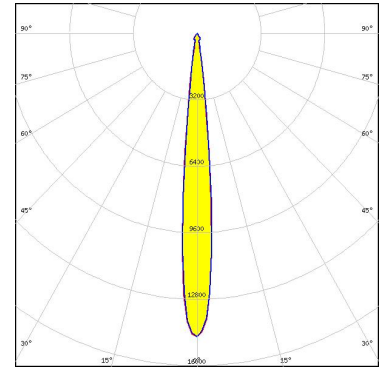

**PHILIPS**

LED Fortimo SLM L23 CoB  
FWHM / FWTM 16.0° / 30.0°  
Efficiency 89 %  
Peak intensity 6.9 cd/lm  
LEDs/each optic 1  
Light colour/type White  
Required components:

BJB: 47.319.2030

Light distribution files

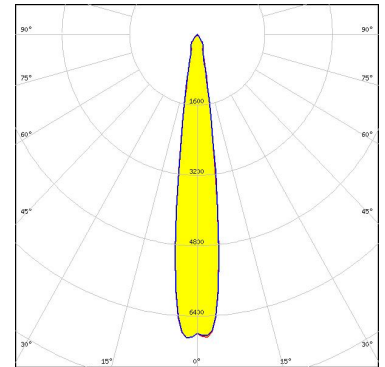

**SAMSUNG**

LED LC040D / LC060D / LC080D  
FWHM / FWTM 17.0° / 36.0°  
Efficiency 87 %  
Peak intensity 5.8 cd/lm  
LEDs/each optic 1  
Light colour/type White  
Required components:

BJB: 47.319.2030

Light distribution files

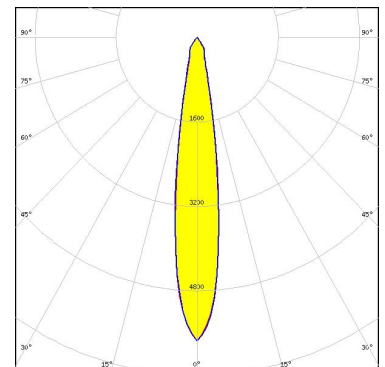

### GENERAL INFORMATION:

NOTE: The typical beam angle will be changed by different color, chip size and chip position tolerance. The typical total beam angle is the full angle measured where the luminous intensity is half of the peak value.

Due to use of high power COB's with this product, special attention to proper thermal design is highly recommended. LEDiL has no liability for direct, indirect or consecutive damages arising from the LEDiL products being used outside of the recommended temperature range.

### MATERIALS:

As part of our continuous research and improvement processes, and to ensure the best possible quality and availability of our products, LEDiL reserves the right to change material grades without notice.

### PRODUCT DATA USER AGREEMENT AND DISCLAIMER:

The measured data in the provided downloadable LEDiL Product Datasheets and Mechanical 2D-Drawings is rounded and provided as reference for planning. LEDiL Oy's optical specifications have been verified by conducting performance testing of the products in accordance with the company's quality system. The reported data are averaged results of multiple measurements with typical variation. LEDiL Oy reserves the right to without prior notification make changes and improvements to its products.

LEDiL Oy assumes neither warranty, nor guarantee nor any other liability of any kind for the contents and correctness of the provided data. The provided data has been generated with highest diligence but the provided data may in reality not represent the complete possible variation range of all intrinsic parameters. Therefore, in certain cases a deviation from the provided data could occur.

LEDiL Oy reserves the right to undertake technical changes of its products without further notification which could lead to changes in the provided data. LEDiL Oy assumes no liability of any kind for the possible deviation from any provided data or any other damage resulting from the usage of the provided data.

The user agrees to this disclaimer and user agreement with the download or usage of the provided files.

#### LEDiL Oy

Joensuunkatu 13  
FI-24240 SALO  
Finland

#### LEDiL Inc.

228 West Page Street  
Suite D  
Sycamore IL 60178  
USA

#### Ledil Optics Technology (Shenzhen) Co., Ltd.

# 405 , Block B  
Casic Motor Building  
Shenzhen 518057  
P.R.CHINA

#### Local sales and technical support

[www.ledil.com/  
where\\_to\\_buy](http://www.ledil.com/where_to_buy)

#### Shipping locations

Poznan, Poland  
Hong Kong, China

#### Distribution Partners

[www.ledil.com/  
where\\_to\\_buy](http://www.ledil.com/where_to_buy)