

Electric cylinder EPCC

FESTO

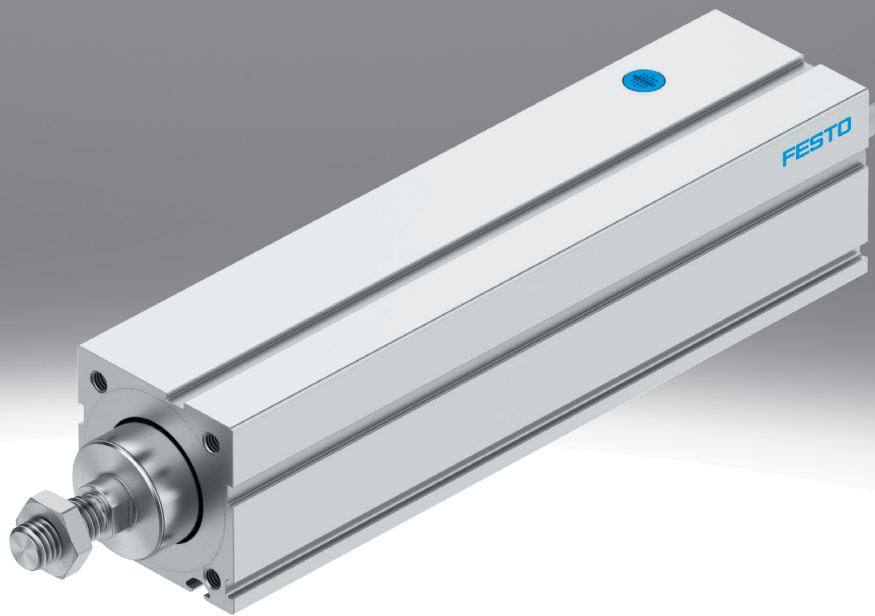

Characteristics

At a glance

Further information → [epcc](#)

The electric cylinder EPCC is a mechanical linear drive with piston rods. The drive element consists of an electrically driven spindle that converts the rotary motion of the motor into a linear motion of the piston rods. Suitable for simple applications in factory automation, which were previously solved mainly pneumatically.

Sealing air connection

- Air is exchanged between the interior of the cylinder and the environment via a sealing air connection. This prevents negative pressure or excess pressure from developing in the cylinder interior.
- Application of slight negative pressure prevents the emission of particles
- Application of slight overpressure prevents the immission of particles

Product segmentation



Festo Core Range

Solves the majority of your automation tasks

With the Festo Core Range, we have selected the most important products and functions from our broad product catalogue, and added the quickest delivery.

the Core Range offers you the best value with the expected high Festo quality.

- Quickest delivery, worldwide – wherever, whenever
- Expected high Festo quality
- Easy and fast to select

Engineering tools

Further information → [electric motion sizing](#)



Save time with engineering tools Smart Engineering for the optimal solution. Our goal is to increase your productivity. Our engineering tools play an integral part in this. They help you size your system correctly, tap into unimagined productivity reserves and generate additional productivity along the entire value chain. In every phase of your project, from the initial contact to the modernisation of your machine, you will come across a number of different tools which will be of use to you.

Electric Motion Sizing

- Create the optimum drive package quickly and reliably. Electric Motion Sizing calculates suitable combinations of electric axis, electric motor and servo drive using just a few application details. It provides all the relevant data including the bill of materials and documentation for your selected combination. This avoids design errors and results in significantly improved energy efficiency for the system. A smooth connection to the Festo Automation Suite also makes commissioning easier for you.

Diagrams

Further information → [epcc](#)



The diagrams shown in this document are also available online. These can be used to display precise values.

Drive system

[BS] Ball screw drive

- For applications that require precision
- High reliability and long service life
- For large loads

Spindle pitch

The spindle pitch describes the distance travelled by the spindle nut per revolution of the spindle in millimetres.

Characteristics

Piston rod thread type

[] Male thread

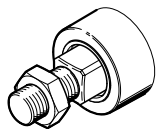

[F] Female thread

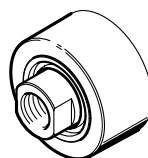

Scraper variant

[] None

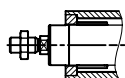

[A7] Wiper

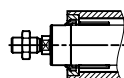

The piston rod has a simple standard wiper that easily removes lightly adhering particles.

Piston rod extension

[...E] 1 ... 100 mm

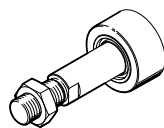

Position sensing

By using proximity switches, any position can be detected.

Guide unit

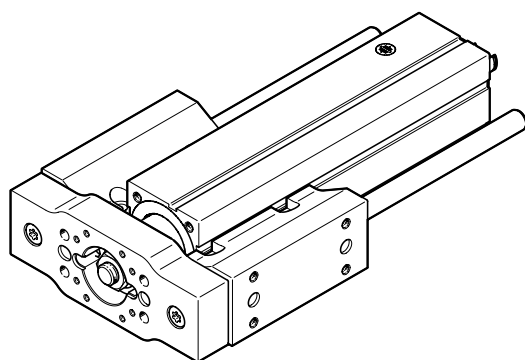

[KF] Recirculating ball bearing with two guide rods

- For protecting the piston rod against rotation
- For precise movements

Type code

001	Series	
EPCC	Electric cylinder	

002	Drive system	
BS	Ball screw drive	

003	Size	
25	25	
32	32	
45	45	
60	60	

004	Stroke [mm]	
25	25	
50	50	
75	75	
100	100	
125	125	
150	150	
175	175	
200	200	
250	250	
300	300	
350	350	
400	400	
500	500	

005	Spindle pitch	
2P	2 mm	
3P	3 mm	
5P	5 mm	
6P	6 mm	
8P	8 mm	
10P	10 mm	
12P	12 mm	

006	Piston rod thread type	
	Male thread	
F	Female thread	

007	Scraper variant	
	None	
A7	Wiper	

008	Piston rod extension	
	None	
...E	1 ... 100 mm	

009	Position sensing	
A	For proximity sensor	

010	Guide unit	
	None	
KF	Recirculating ball bearing with two guide rods	

Datasheet

General technical data				
Size	25	32	45	60
Design	Electric cylinder, With ball screw drive			
Piston rod thread	M6	M8	M10x1.25	M12x1.25
Piston-rod end	Male thread			
Stroke	25 ... 200 mm		25 ... 300 mm	25 ... 500 mm
Stroke reserve	0 mm			
Protection against torque/ guide	With plain-bearing guide			
Torsional backlash at piston rod +/-	1 deg			
Position detection	Via proximity switch			
Type of mounting	With accessories		Via female thread, With accessories	
Mounting position	optional			

Mechanical data								
Size	25		32		45		60	
Spindle pitch	2 mm/U	6 mm/U	3 mm/U	8 mm/U	3 mm/U	10 mm/U	5 mm/U	12 mm/U
Spindle diameter	6 mm		8 mm		10 mm		12 mm	
Reference value effective load, horizontal	12 kg		24 kg		60 kg		120 kg	
Reference value effective load, vertical	6 kg		12 kg		30 kg		60 kg	
Max. feed force F _x	75 N		150 N		450 N		1,000 N	
Max. radial force at drive shaft	30		75		180		230	
Max. drive torque	0.05 Nm	0.1 Nm	0.15 Nm	0.3 Nm	0.4 Nm	0.9 Nm	1.2 Nm	2.4 Nm
Frictional torque independent of load ¹⁾	0.02 Nm	0.055 Nm	0.065 Nm	0.095 Nm	0.08 Nm	0.16 Nm	0.235 Nm	0.325 Nm
Max. speed ²⁾	0.067 ... 0.133 m/s	0.2 ... 0.4 m/s	0.188 m/s	0.5 m/s	0.18 m/s	0.6 m/s	0.25 m/s	0.6 m/s
Max. acceleration	5 m/s ²	15 m/s ²	5 m/s ²	15 m/s ²	5 m/s ²	15 m/s ²	5 m/s ²	15 m/s ²
Max. rotational speed	4,000 rpm		3,750 rpm		3,600 rpm		3,000 rpm	
Reversing backlash theoret- ical ³⁾	100 µm							
Repetition accuracy	±0.02 mm							

1) Corresponds to the required drive torque without load at spindle speed of 200 rpm.

2) The speed depends on the stroke.

3) In new condition

Operating and environmental conditions	
Ambient temperature ¹⁾	0 ... 60°C
Storage temperature	-20 ... 60°C
Relative air humidity	0 - 95%, Non-condensing
Degree of protection	IP40
Duty cycle	100%
Cleanroom class	Class 9 according to ISO 14644-1
Maintenance interval	Life-time lubrication

1) Note the operating range of the proximity switches

Weight				
Size	25	32	45	60
Basic weight for 0 mm stroke	132 g	225 g	555 g	1,114 g
Additional weight per 10 mm stroke	13 g	24 g	41 g	69 g
Moving mass for 0 mm stroke	53 g	98 g	179 g	305 g
Additional moving mass per 10 mm stroke	2.6 g	3.3 g	4.9 g	6.5 g

Datasheet

Mass moments of inertia

$$J_A = J_O + J_H \cdot l + J_L \cdot m$$

The mass moment of inertia J of the electric cylinder is calculated as follows.

l = working stroke

m = moving payload

Size	25		32		45		60	
Spindle pitch	2 mm/U	6 mm/U	3 mm/U	8 mm/U	3 mm/U	10 mm/U	5 mm/U	12 mm/U
Mass moment of inertia JO	0.001 kgcm ²		0.004 kgcm ²	0.005 kgcm ²	0.011 kgcm ²	0.015 kgcm ²	0.068 kgcm ²	0.078 kgcm ²
Mass moment of inertia JH per metre of stroke	0.006 kgcm ²	0.009 kgcm ²	0.026 kgcm ²	0.031 kgcm ²	0.05 kgcm ²	0.071 kgcm ²	0.119 kgcm ²	0.152 kgcm ²
Mass moment of inertia JL per kg of working load	0.001 kgcm ²	0.009 kgcm ²	0.002 kgcm ²	0.016 kgcm ²	0.002 kgcm ²	0.025 kgcm ²	0.006 kgcm ²	0.036 kgcm ²

Homing

Homing can be carried out in two ways:

- Against the fixed stop
- Using a reference switch

The following values must be observed:

Size	25	32	45	60
Impact energy in end positions	0.001 J	0.004 J	0.012 J	0.024 J
Max. homing speed	0.01 m/s			

Materials

Material housing	Wrought aluminium alloy, Smooth anodised
Material piston rod	High-alloy stainless steel
Material spindle nut	Steel
Material spindle	Rolled steel
Note on materials	RoHS-compliant
LABS (PWIS) conformity	VDMA24364 zone III
Suitability for the production of Li-ion batteries	Metals with more than 1% by mass of copper, zinc or nickel by mass are excluded from use. Exceptions are nickel in steel, chemically nickel-plated surfaces, printed circuit boards, cables, electrical plug connectors and coils

Max. permissible loads on the piston rod

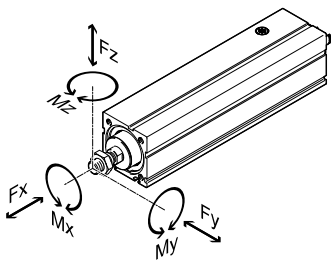

Size	25	32	45	60
Max. feed force Fx	75 N	150 N	450 N	1,000 N
Max. moment Mx	0 Nm			
Max. moment My	0.6 Nm	1.5 Nm	2.9 Nm	6.4 Nm
Max. moment Mz	0.6 Nm	1.5 Nm	2.9 Nm	6.4 Nm

Datasheet

Max. permissible transverse forces on the piston rod as a function of cantilever load A

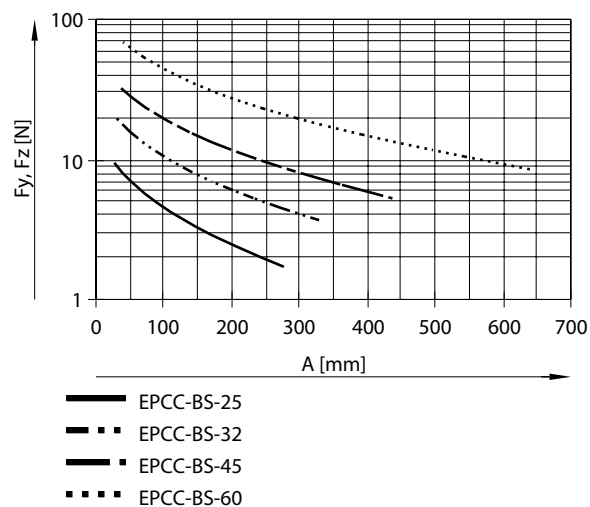

Piston rod deflection f as a function of cantilever load A and transverse force F

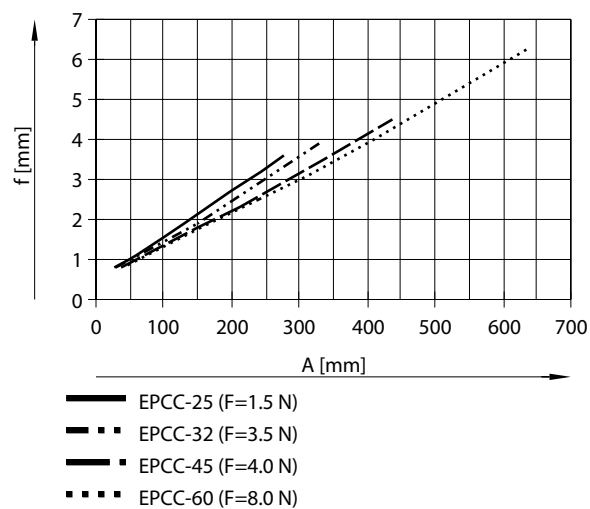

Piston rod deflection f as a function of cantilever load A and lateral force F

$$f_1 = \frac{F_1}{F_2} \cdot f_2$$

f1 = Piston rod deflection caused by lateral force [mm]

F1 = lateral force [N]

F2 = Standardised lateral force [N] (constant force from graph)

f2 = Piston rod deflection caused by lateral force [N] (reading from graph)

Datasheet

Feed speed v as a function of stroke length l for size 25

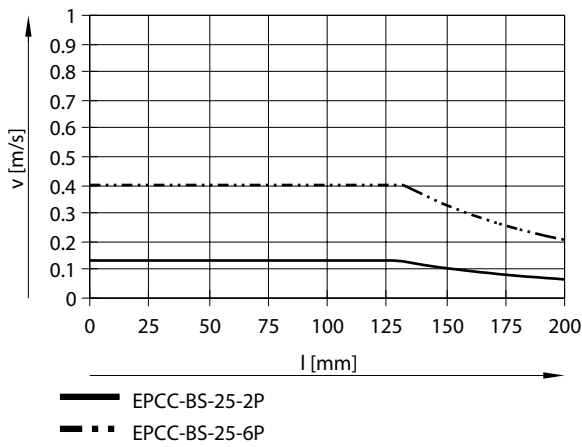

Feed speed v as a function of stroke length l for size 32

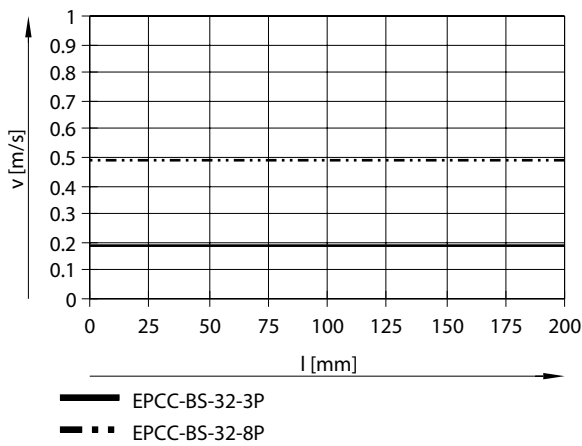

Feed speed v as a function of stroke length l for size 45

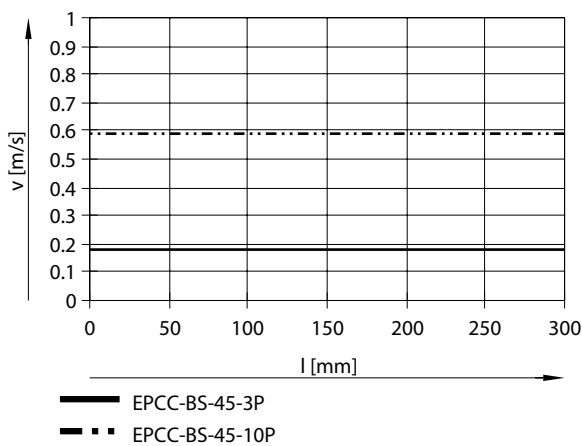

Datasheet

Feed speed v as a function of stroke length l for size 60

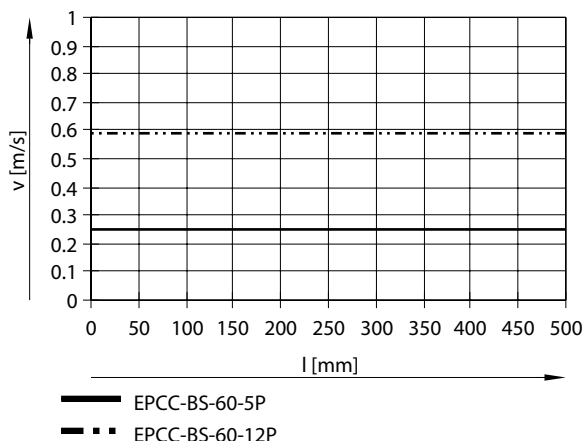

Calculating the mean feed force F (to DIN 69051-4)

$$F_{xm} = \sqrt[3]{\sum F_x^3 \cdot \frac{v_x}{v_{xm}} \cdot \frac{q}{100}} =$$

$$F_{xm} = \sqrt[3]{F_{x1}^3 \cdot \frac{v_{x1}}{v_{xm}} \cdot \frac{q_1}{100} + F_{x2}^3 \cdot \frac{v_{x2}}{v_{xm}} \cdot \frac{q_2}{100} + F_{x3}^3 \cdot \frac{v_{x3}}{v_{xm}} \cdot \frac{q_3}{100} + \dots}$$

The peak feed force value must not exceed the maximum feed force within a movement cycle. The peak value is generally achieved in vertical operation during the acceleration phase of the upward stroke. If the maximum feed force is exceeded, this can increase wear and thus shorten the service life of the ball screw. The maximum speed must likewise not be exceeded.

During operation, the continuous feed force may be briefly exceeded up to the maximum feed force. The continuous feed force must, however, be adhered to when averaged over a movement cycle.

Mean feed speed v (according to DIN 69051-4)

$$v_{xm} = \sum v_x \cdot \frac{q}{100} = v_{x1} \cdot \frac{q_1}{100} + v_{x2} \cdot \frac{q_2}{100} + v_{x3} \cdot \frac{q_3}{100} + \dots$$

F_x = feed force
 F_{xm} = mean feed force
 q = time
 v_x = feed speed
 v_{xm} = mean feed speed

Mean feed force F as a function of running performance L, at an operating coefficient of 1.0 and room temperature for size 25

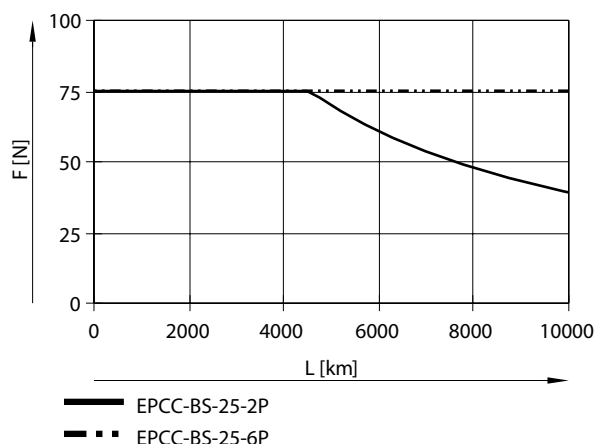

The specifications for running performance are based on experimentally determined and theoretically calculated data (at room temperature). The running performance that can be achieved in practice can deviate considerably from the specified curves under different characteristic curves.

Datasheet

Mean feed force F as a function of running performance L, at an operating coefficient of 1.0 and room temperature for size 32

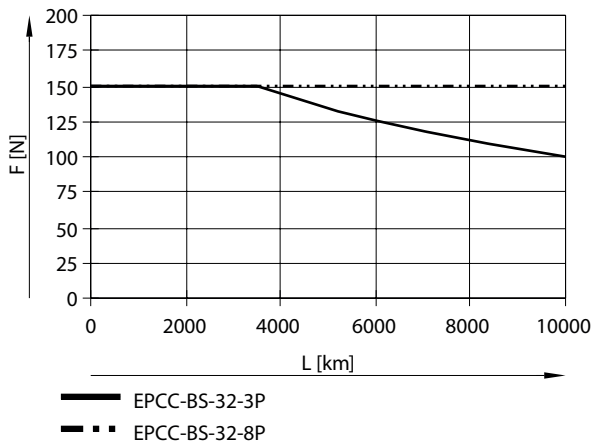

The specifications for running performance are based on experimentally determined and theoretically calculated data (at room temperature). The running performance that can be achieved in practice can deviate considerably from the specified curves under different characteristic curves.

Mean feed force F as a function of running performance L, at an operating coefficient of 1.0 and room temperature for size 45

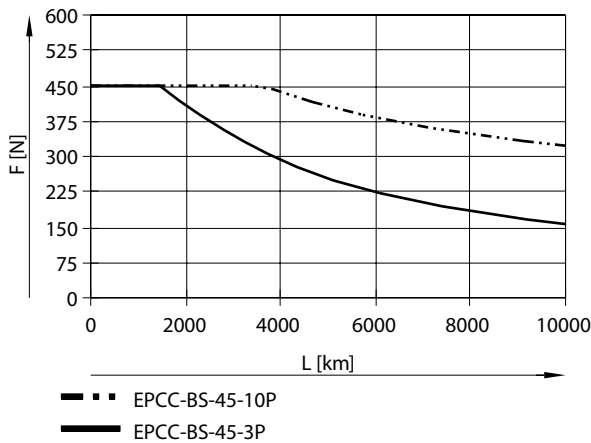

The specifications for running performance are based on experimentally determined and theoretically calculated data (at room temperature). The running performance that can be achieved in practice can deviate considerably from the specified curves under different characteristic curves.

Mean feed force F as a function of running performance L, at an operating coefficient of 1.0 and room temperature for size 60

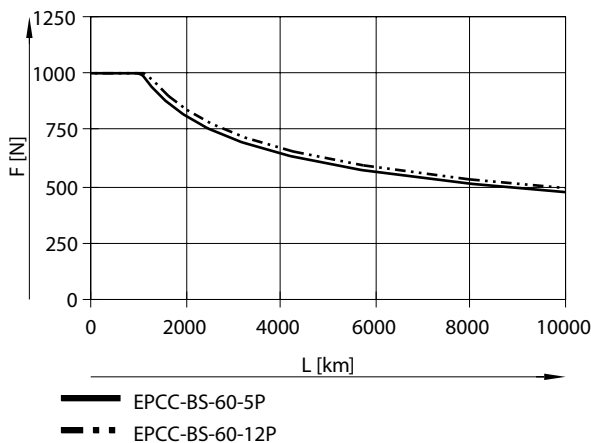

The specifications for running performance are based on experimentally determined and theoretically calculated data (at room temperature). The running performance that can be achieved in practice can deviate considerably from the specified curves under different characteristic curves.

Datasheet

Service life taking into account the operating coefficient

$$L_1 = \frac{L}{f_B^3}$$

Operating coefficient f_B
 1.0 ... 1.2 (for measuring machine)
 1.2 ... 1.4 (for handling technology, robotics)
 1.4 ... 1.6 (for press-fitting operations)
 1.6 ... 2.0 (for construction, agriculture)

L_1 = actual service life
 L = target service life
 f_B = operating coefficient

This refers to stress caused by impact, temperature, contamination, shock and vibrations that affect the cylinder or piston rod.

Frictional torque M as a function of feed speed v for size 25

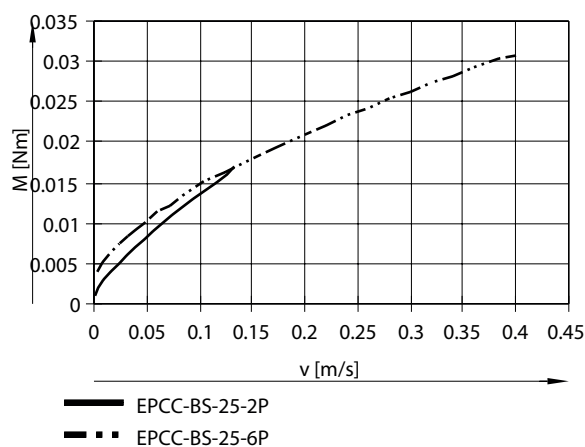

Frictional torque M as a function of feed speed v for size 32

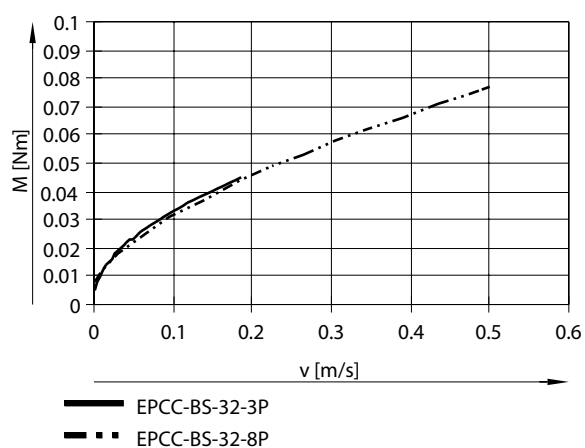

Datasheet

Frictional torque M as a function of feed speed v for size 45

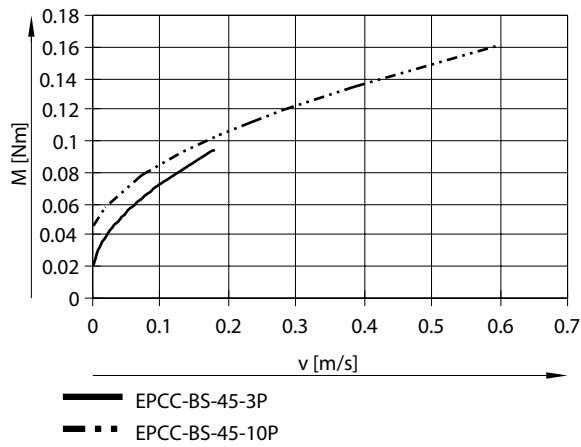

Frictional torque M as a function of feed speed v for size 60

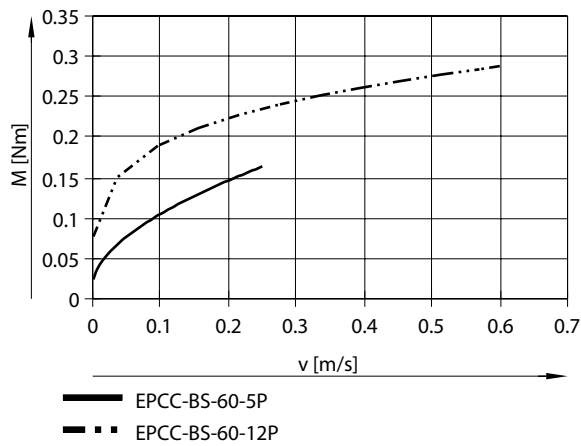

Effective torque M as a function of feed force F for size 25

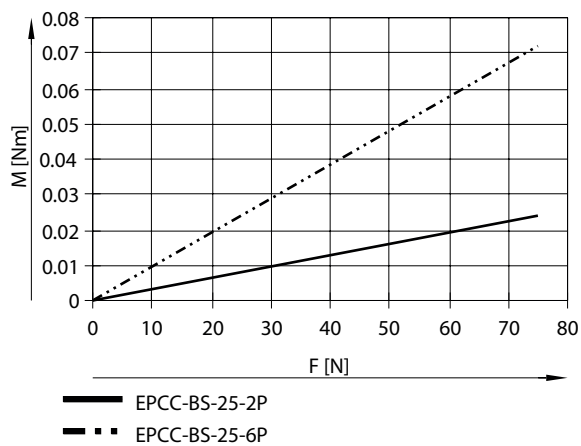

Datasheet

Effective torque M as a function of feed force F for size 32

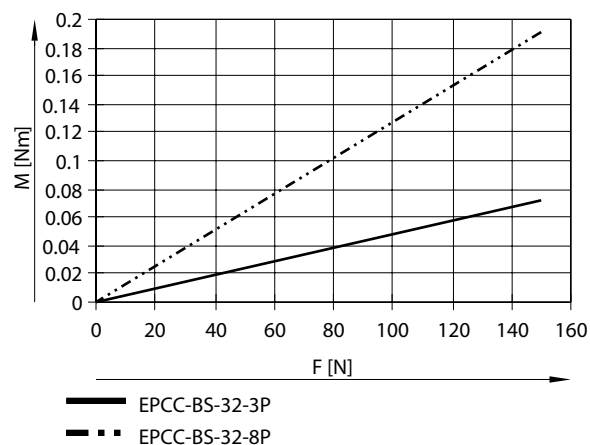

Effective torque M as a function of feed force F for size 45

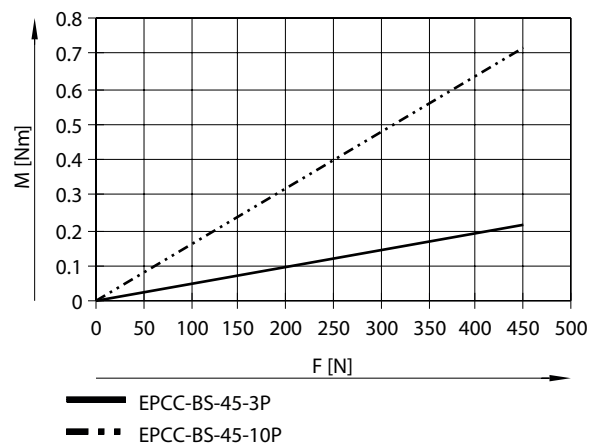

Effective torque M as a function of feed force F for size 60

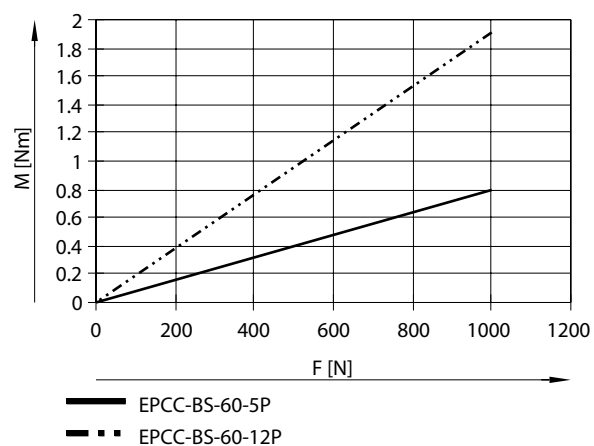

Dimensions

Dimensions – EPCC with spindle drive

Download CAD data → www.festo.com

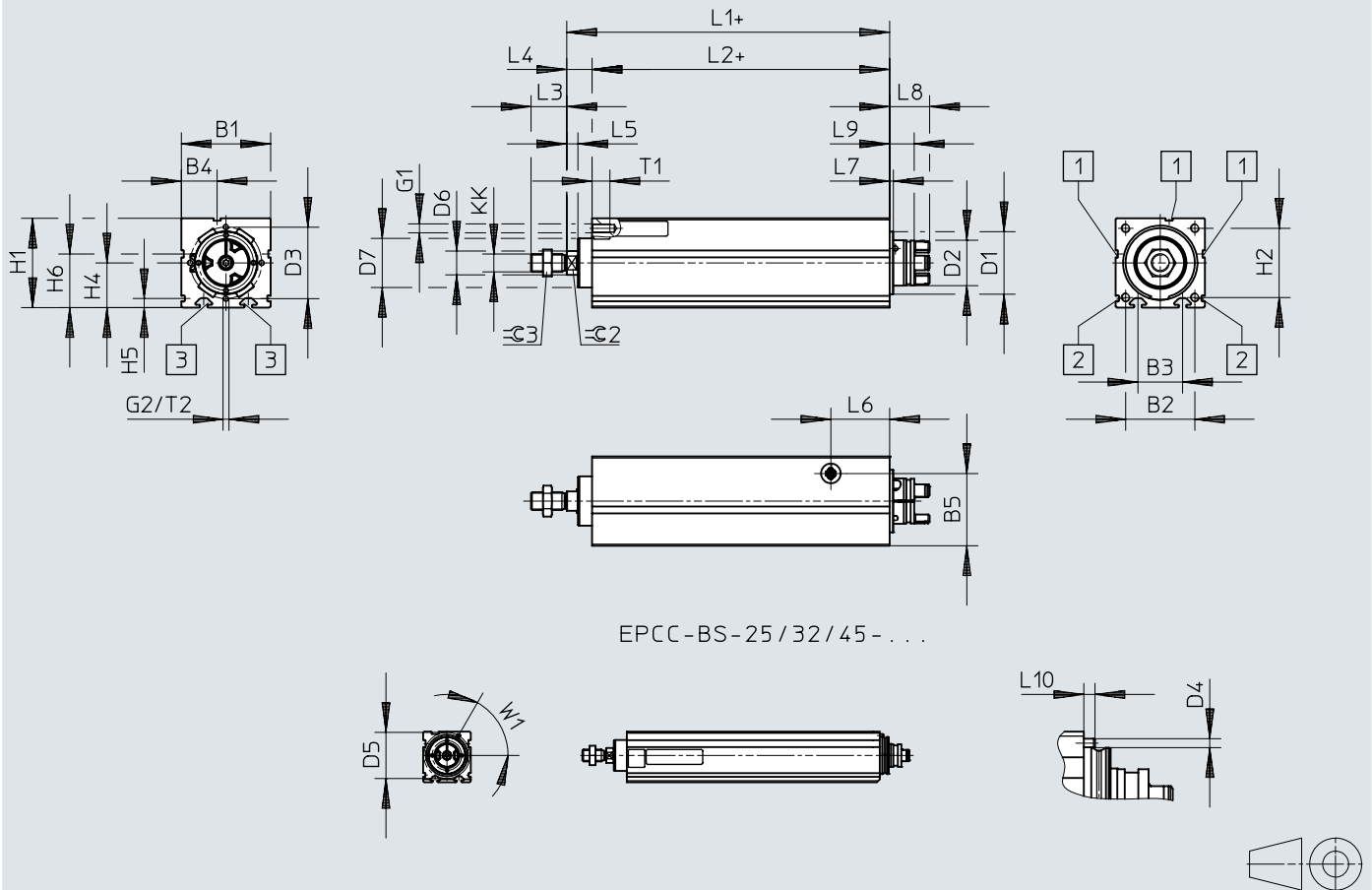

- [1] For sensor bracket
- [2] For profile mounting
- [3] For slot nut mounting
- [4] Orientation of the spanner flat 2 is not clear

Dimensions

	B1 ±0,15	B2	B3	B4	B5	D1 ∅	D2 ¹⁾ ∅	D3 ∅	D4 ∅
EPCC-BS-25	25	–	14	5,8	20	20,5	10,8	–	2
EPCC-BS-32	32	24	16	8,1	25,5	25	15,5	–	2
EPCC-BS-45	45	32,5	24	16,5	35	32	16,3	–	3
EPCC-BS-60	60	46,5	30	24	48,5	42	31,4	48	–

	D5 ∅	D6 ∅	D7 ∅	G1	G2	H1 ±0,15	H2	H3	H4
EPCC-BS-25	25	8	17,3	–	–	27	–	4,7	–
EPCC-BS-32	31	10	21,3	M4	–	34	24	4,7	–
EPCC-BS-45	41	12	26,5	M5	–	45	32,5	6,3	–
EPCC-BS-60	–	16	33,6	M6	M4	60	46,5	7,3	30

	H5	H6 +0,15	KK	L1	L2	L3	L4	L5	L6
EPCC-BS-25	4,9	22,5	M6	74,5	60	12	14,5	4,7	19,2
EPCC-BS-32	4,9	26	M8	82,9	70	16	12,9	5,2	24,2
EPCC-BS-45	6,1	28,5	M10x1,25	99,9	83	20	16,9	5,7	30,5
EPCC-BS-60	6,1	36	M12x1,25	116	100	24	16	7,5	39,5

	L7	L8	L9	L10	T1	T2	W1	∠C1	∠C2	∠C3
EPCC-BS-25	5	15	10,5	2,5	–	–	60°	6	7	10
EPCC-BS-32	6	19,9	14,5	2,5	8	–	60°	6	9	13
EPCC-BS-45	6	19,9	14,5	3	10	–	60°	12	10	16
EPCC-BS-60	2,5	26,9	16,5	–	12	10	–	15	13	18

1) Coupling diameter or interference circuit diameter clamping screw

Dimensions

Dimensions – EPCC-...-...E (piston rod extension)

Download CAD data → www.festo.com

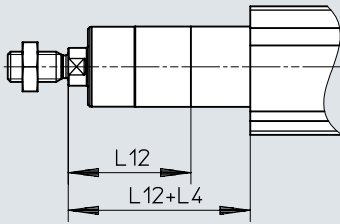

	L4	L12
		max.
EPCC-BS-25-...-...E	14,5	50
EPCC-BS-32-...-...E	12,9	100
EPCC-BS-45-...-...E	16,9	100
EPCC-BS-60-...-...E	16	100

Dimensions

Dimensions – EPCC-...-F (female thread)

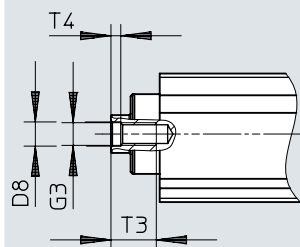
Download CAD data → www.festo.com

	D8 ∅	G3	T3	T4
EPCC-BS-25-...-F	4,3	M4	10	1,5
EPCC-BS-32-...-F	6,4	M6	12	2,6
EPCC-BS-45-...-F	8,4	M8	14	3,3
EPCC-BS-60-...-F	10,5	M10	16	4,7

Dimensions

Dimensions – Profile mounting EAHF-L2-...-P-S

Download CAD data → www.festo.com

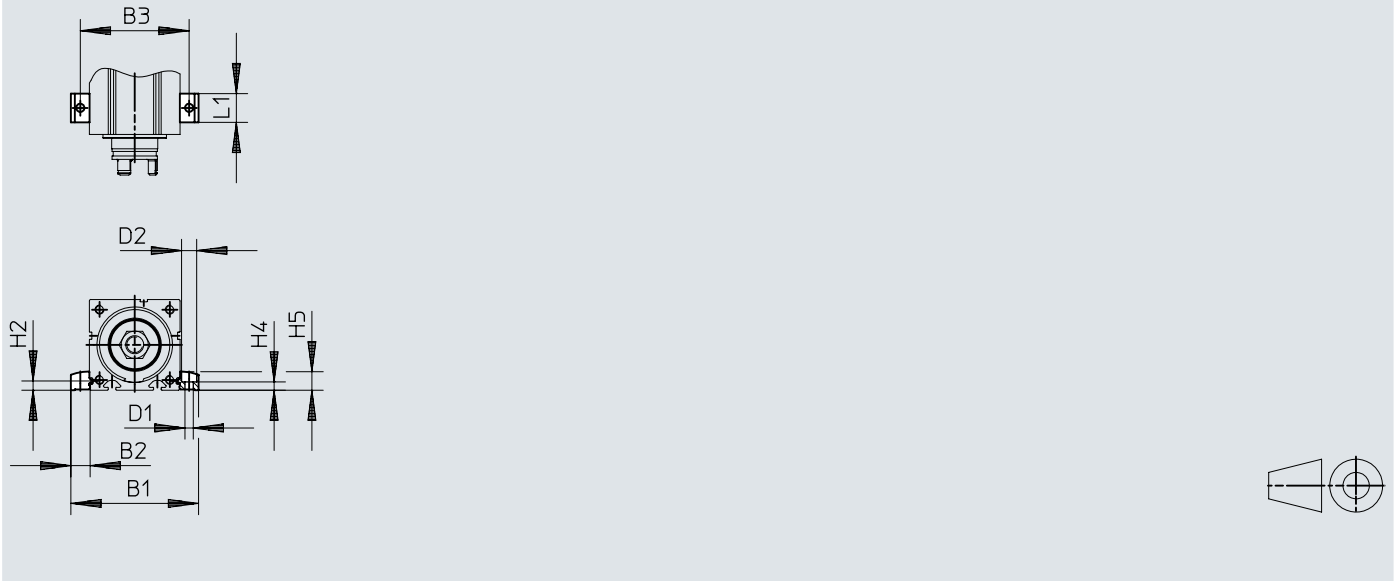

		B1	B2	B3	D1 ∅ H13	D2 ∅ H13	H2	H4 ±0,1	H5	L1
EAHF-L2-25-P-S	EPCC-BS-25	44,4	9,7	35	4,5	8	4,9	4,2	9	19
EAHF-L2-25-P-S	EPCC-BS-32	51,4	9,7	42	4,5	8	4,9	4,2	9	19
EAHF-L2-45-P-S	EPCC-BS-45	70,6	12,8	58	5,5	10	6,1	5,5	12,2	19
EAHF-L2-45-P-S	EPCC-BS-60	85,6	12,8	73	5,5	10	6,1	5,5	12,2	19

Dimensions

Dimensions – Profile mounting EAHF-L2-...-P

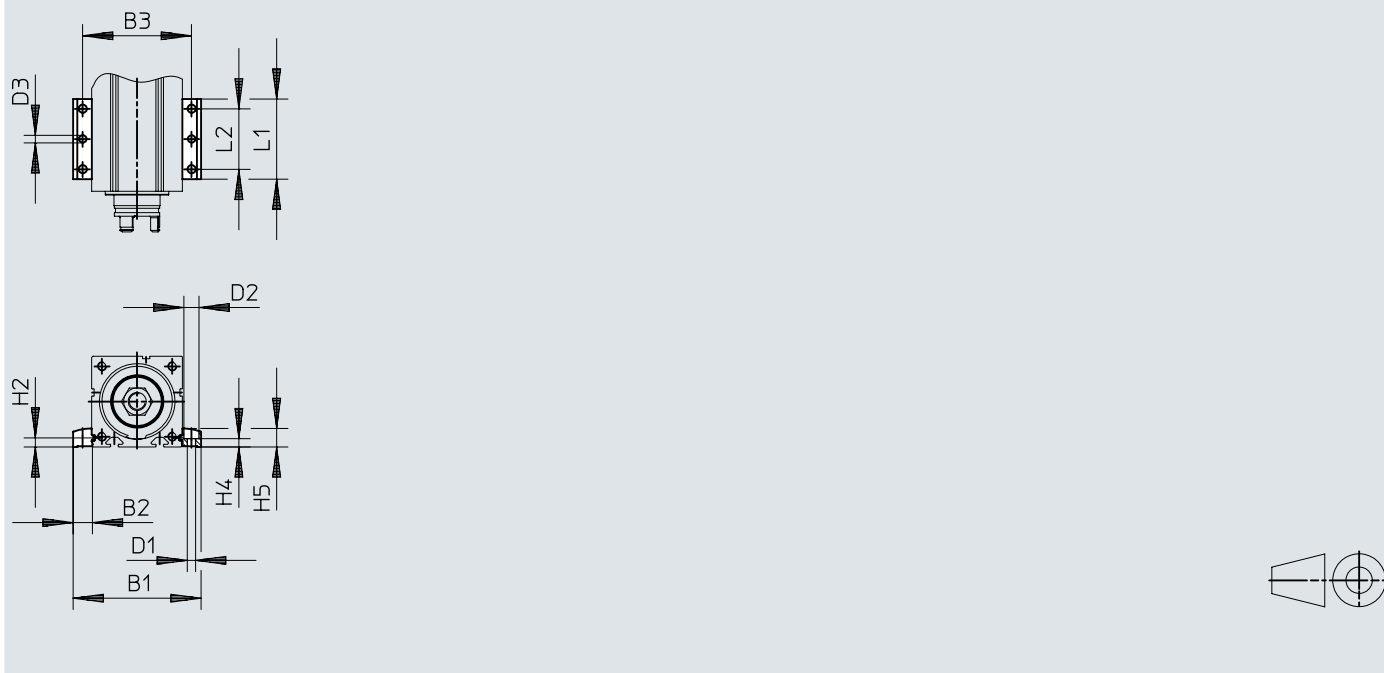
Download CAD data → www.festo.com

		B1	B2	B3	D1 ∅ H13	D2 ∅ H13	D3 ∅	H2	H4 ±0,1	H5	L1	L2
EAHF-L2-25-P	EPCC-BS-25	44,4	9,7	35	4,5	8	4	4,9	4,2	9	53	40
EAHF-L2-25-P	EPCC-BS-32	51,4	9,7	42	4,5	8	4	4,9	4,2	9	53	40
EAHF-L2-45-P	EPCC-BS-45	70,6	12,8	58	5,5	10	5	6,1	5,5	12,2	53	40
EAHF-L2-45-P	EPCC-BS-60	85,6	12,8	73	5,5	10	5	6,1	5,5	12,2	53	40

Dimensions

Dimensions – Flange mounting EAHH

Download CAD data → www.festo.com

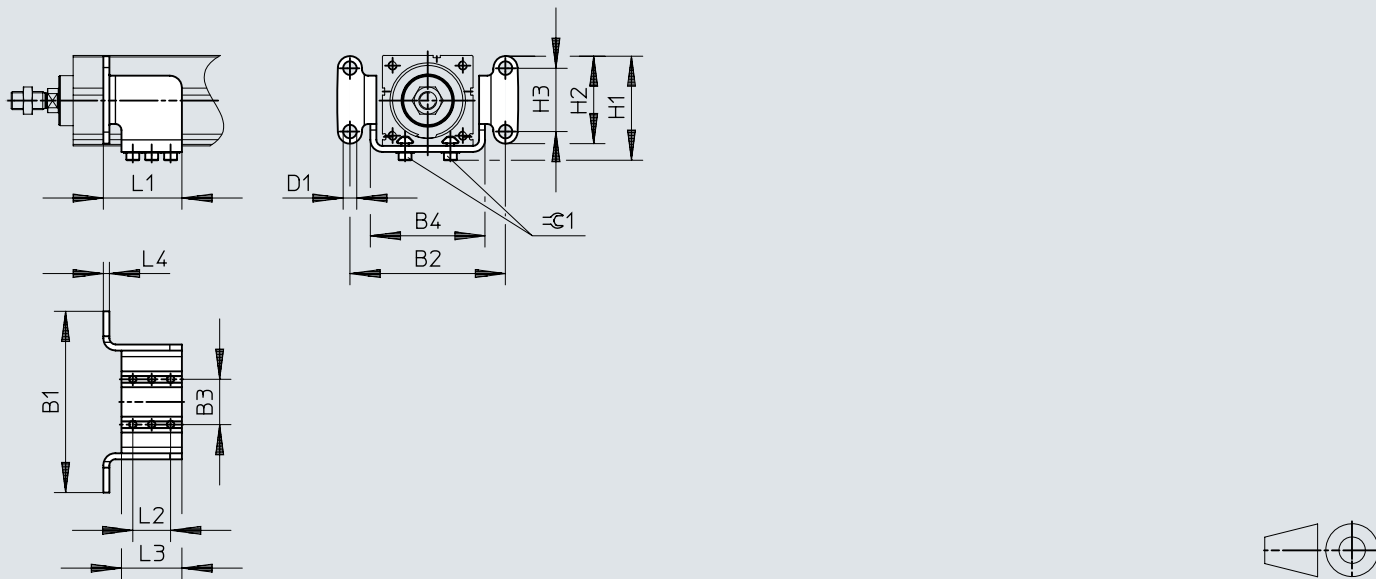

[1] The position is freely selectable along the entire cylinder length.

	B1	B2	B3 ±0,1	B4	D1 ∅	H1	H2	H3	L1	L2	L3	L4	⊕1
EAHH-P2-25	61	50	14	35	4,5	32,5	25	15	38	20	30	2,5	2,5
EAHH-P2-32	70	58	16	42	5,5	39	31	20	38	20	30	2,5	2,5
EAHH-P2-45	100	85	24	61	6,6	54,5	48	35	42	20	30	4	2,5
EAHH-P2-60	120	103	30	76	9	69	58	42	52	25	40	4	4

Dimensions

Dimensions – Adapter kit EAHA

Download CAD data → www.festo.com

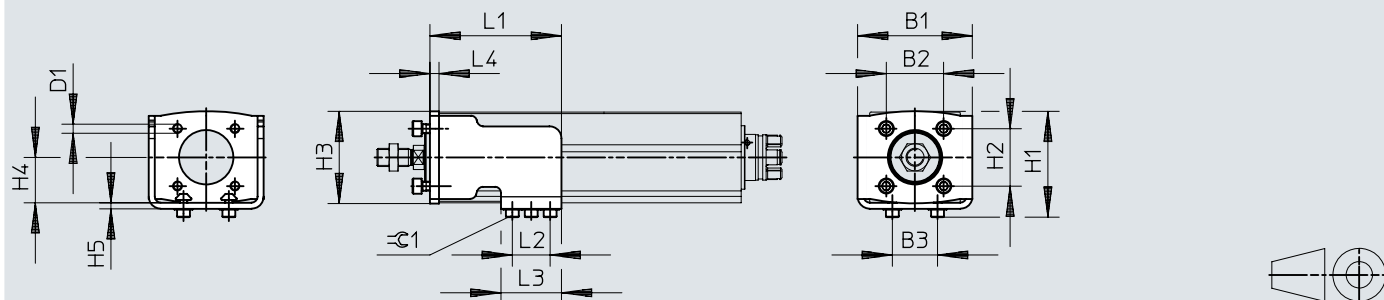

	B1	B2	B3	D1	H1	H2	H3	H4	H5	L1	L2	L3	L4	$\varnothing 1$
		$\pm 0,2$	$\pm 0,1$	\varnothing		$\pm 0,2$								
EAHA-P2-25	37	18	14	M4	35	18	30	14,5	2,5	58	20	30	4	2,5
EAHA-P2-32	53	22	16	M5	42	22	37	18	2,5	64	20	30	4	2,5
EAHA-P2-45	61	32,5	24	M6	54	32,5	49	22,5	4	68	20	30	6	2,5
EAHA-P2-60	76	38	30	M6	69,5	38	61	30	4	87	25	40	6	4

Dimensions

Dimensions – Swivel mounting EAHS

Download CAD data → www.festo.com

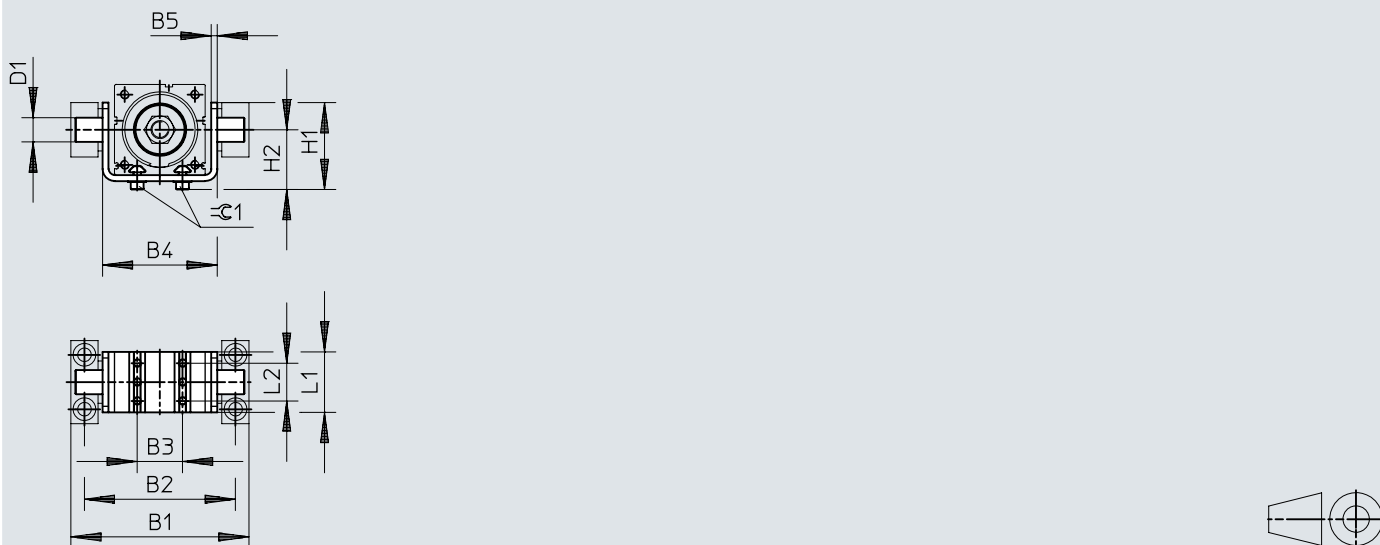

[1] The position is freely selectable along the entire cylinder length.

	B1	B2	B3 ±0,1	B4	B5	D1 ∅ e9	H1	H2	L1	L2	≙1
EAHS-P2-25	61	50	14	35	2,5	8	30	20	30	20	2,5
EAHS-P2-32	68	57	16	42	2,5	8	32	23,5	30	20	2,5
EAHS-P2-45	98	83	24	62	4	12	44,5	29,5	30	20	2,5
EAHS-P2-60	118	100	30	76	4	16	57	39	40	25	4

Dimensions

Dimensions – Trunnion support LNZG

Download CAD data → www.festo.com

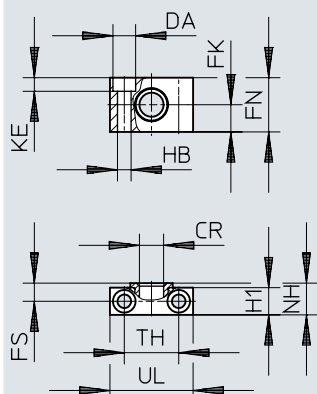

	CR ∅ D11	DA ∅ H13	FK ±0,1	FN	FS	H1	HB ∅ H13	KE	NH	TH ±0,2	UL
LNZG-32	12	11	15	30	10,5	15	6,6	6,8	18	32	46
LNZG-40/50	16	15	18	36	12	18	9	9	21	36	55
LNZG-63/80	20	18	20	40	13	20	11	11	23	42	65
LNZG-100/125	25	20	25	50	16	24,5	14	13	28,5	50	75

Dimensions

Dimensions – Swivel flange SNCS

Download CAD data → www.festo.com

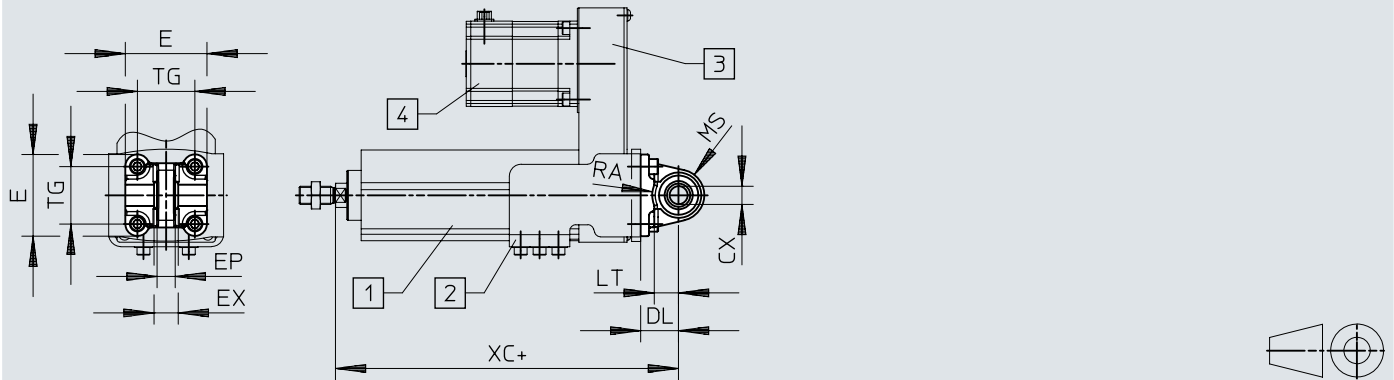

- [1] Electric cylinder EPCC
- [2] Adapter kit EAHA
- [3] Parallel kit EAMM-U
- [4] Motor EMME, EMMT
- [5] + = plus stroke length

		CX	DL	E	L	EP	EX	LT	MS	RA	TG	XC
			±0,2			±0,2						
SNCS-32	EPCC-BS-45	10 ^{+0,13}	22	45 ^{+0,2/-0,5}	3	10,5	14	13	15	14,5	32,5	154,9
SNCS-40	EPCC-BS-60	12 ^{+0,15}	25	54 _{-0,5}	3	12	16	16	17	17,5	38	182

Dimensions

Dimensions – Swivel flange SNCL

Download CAD data → www.festo.com

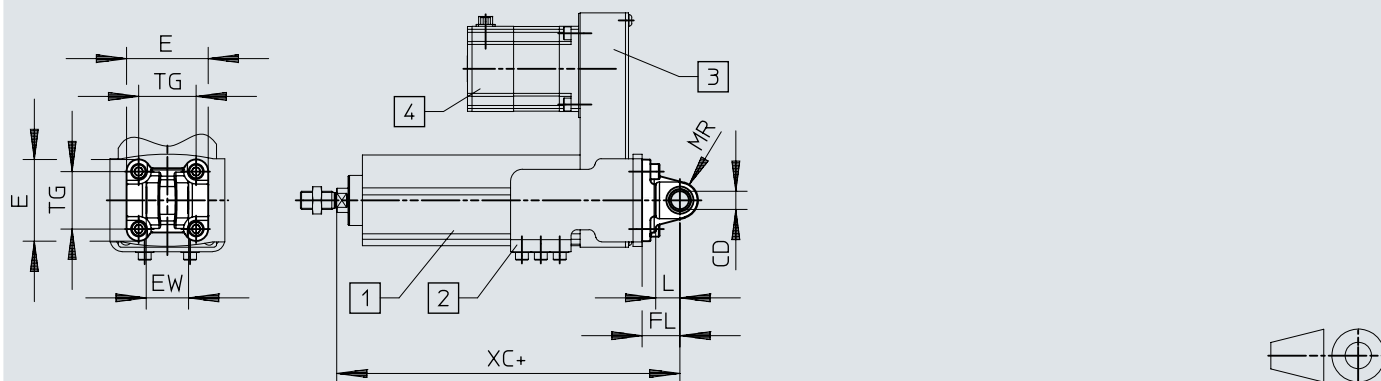

- [1] Electric cylinder EPCC
- [2] Adapter kit EAHA
- [3] Parallel kit EAMM-U
- [4] Motor EMME, EMMT
- [5] + = plus stroke length

		CD ∅ H10	E	EW h12	FL ±0,2	L	LT	MR	TG	XC
SNCL-16	EPCC-BS-25	6	27,5 _{-0,6}	12 _{h12}	16	3	10	6	18	115,7
SNCL-20	EPCC-BS-32	8	34,5 _{-0,6}	16 _{h12}	20	3	14	8	22	133,9
SNCL-32	EPCC-BS-45	10	45 _{+0,2/-0,5}	26 _{-0,2/-0,6}	22	3	13	10	32,5	154,9
SNCL-40	EPCC-BS-60	12	54 _{-0,5}	28 _{-0,2/-0,6}	25	3	16	12	38	182

Dimensions

Dimensions – Swivel flange SNCB

Download CAD data → www.festo.com

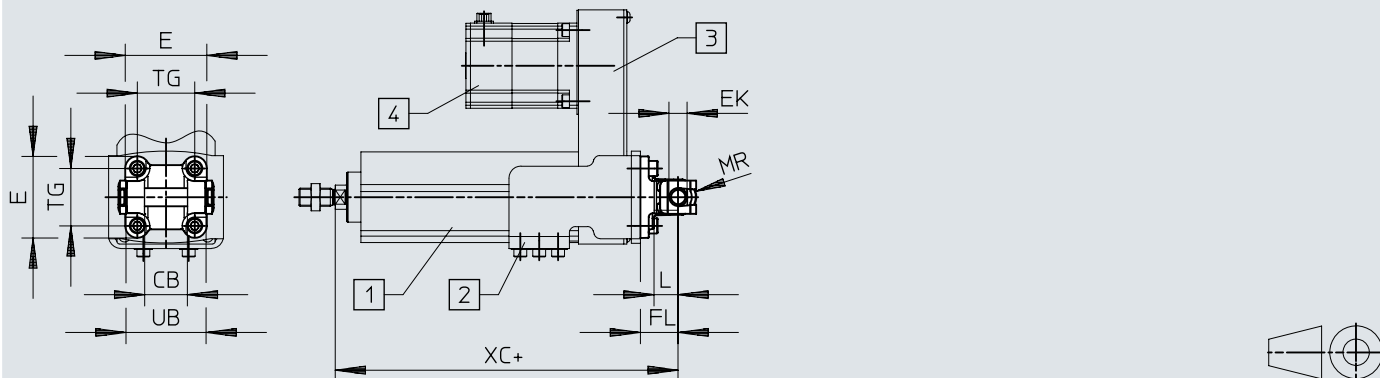

- [1] Electric cylinder EPCC
- [2] Adapter kit EAHA
- [3] Parallel kit EAMM-U
- [4] Motor EMME, EMMT
- [5] + = plus stroke length

		CB	E	EK ∅	FL	L	LT	MR	TG	UB	XC
		H14		H10/e8	±0,2			-0,5		h14	
SNCB-32	EPCC-BS-45	26	45+0,2/-0,5	10	22	3	13	8,5	32,5	45	154,9
SNCB-40	EPCC-BS-60	28	54-0,5	12	25	3	16	12	38	52	182

Dimensions

Dimensions – Sensor bracket EAPM-L2

Download CAD data → www.festo.com

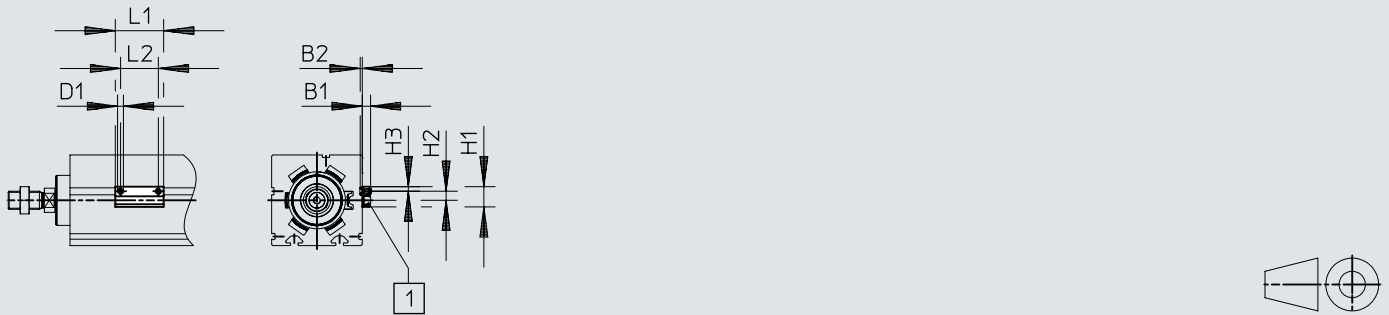



[1] Proximity switches SME-8- ..., SMT-8- ...

	B1	B2	D1	H1	H2	H3	L1	L2
EAPM-L2-SH	5,5	1,3	M4	13,4	6	3	32	25

Ordering data

EPCC-BS-25				
	Stroke	Spindle pitch	Part no.	Type
	25 mm	2 mm/U	5428805	EPCC-BS-25-25-2P-A
		6 mm/U	5428813	EPCC-BS-25-25-6P-A
	50 mm	2 mm/U	5428806	EPCC-BS-25-50-2P-A
		6 mm/U	5428814	EPCC-BS-25-50-6P-A
	75 mm	2 mm/U	5428807	EPCC-BS-25-75-2P-A
		6 mm/U	5428815	EPCC-BS-25-75-6P-A
	100 mm	2 mm/U	5428808	EPCC-BS-25-100-2P-A
		6 mm/U	5428816	EPCC-BS-25-100-6P-A
	125 mm	2 mm/U	5428809	EPCC-BS-25-125-2P-A
		6 mm/U	5428817	EPCC-BS-25-125-6P-A
	150 mm	2 mm/U	5428810	EPCC-BS-25-150-2P-A
		6 mm/U	5428818	EPCC-BS-25-150-6P-A
	175 mm	2 mm/U	5428811	EPCC-BS-25-175-2P-A
		6 mm/U	5428819	EPCC-BS-25-175-6P-A
	200 mm	2 mm/U	5428812	EPCC-BS-25-200-2P-A
		6 mm/U	5428820	EPCC-BS-25-200-6P-A

EPCC-BS-32				
	Stroke	Spindle pitch	Part no.	Type
	25 mm	3 mm/U	5428833	EPCC-BS-32-25-3P-A
		8 mm/U	5428841	EPCC-BS-32-25-8P-A
	50 mm	3 mm/U	★ 5428834	EPCC-BS-32-50-3P-A
		8 mm/U	★ 5428842	EPCC-BS-32-50-8P-A
	75 mm	3 mm/U	5428835	EPCC-BS-32-75-3P-A
		8 mm/U	5428843	EPCC-BS-32-75-8P-A
	100 mm	3 mm/U	★ 5428836	EPCC-BS-32-100-3P-A
		8 mm/U	★ 5428844	EPCC-BS-32-100-8P-A
	125 mm	3 mm/U	5428837	EPCC-BS-32-125-3P-A
		8 mm/U	5428845	EPCC-BS-32-125-8P-A
	150 mm	3 mm/U	★ 5428838	EPCC-BS-32-150-3P-A
		8 mm/U	★ 5428846	EPCC-BS-32-150-8P-A
	175 mm	3 mm/U	5428839	EPCC-BS-32-175-3P-A
		8 mm/U	5428847	EPCC-BS-32-175-8P-A
	200 mm	3 mm/U	★ 5428840	EPCC-BS-32-200-3P-A
		8 mm/U	★ 5428848	EPCC-BS-32-200-8P-A

EPCC-BS-45				
	Stroke	Spindle pitch	Part no.	Type
	25 mm	3 mm/U	★ 5428858	EPCC-BS-45-25-3P-A
		10 mm/U	★ 5428868	EPCC-BS-45-25-10P-A
	50 mm	3 mm/U	★ 5428859	EPCC-BS-45-50-3P-A
		10 mm/U	★ 5428869	EPCC-BS-45-50-10P-A
	75 mm	3 mm/U	5428860	EPCC-BS-45-75-3P-A
		10 mm/U	5428870	EPCC-BS-45-75-10P-A
	100 mm	3 mm/U	★ 5428861	EPCC-BS-45-100-3P-A
		10 mm/U	★ 5428871	EPCC-BS-45-100-10P-A
	125 mm	3 mm/U	5428862	EPCC-BS-45-125-3P-A
		10 mm/U	5428872	EPCC-BS-45-125-10P-A
	150 mm	3 mm/U	★ 5428863	EPCC-BS-45-150-3P-A
		10 mm/U	★ 5428873	EPCC-BS-45-150-10P-A
	175 mm	3 mm/U	5428864	EPCC-BS-45-175-3P-A
		10 mm/U	5428874	EPCC-BS-45-175-10P-A
	200 mm	3 mm/U	★ 5428865	EPCC-BS-45-200-3P-A
		10 mm/U	★ 5428875	EPCC-BS-45-200-10P-A

Ordering data

EPCC-BS-45				
	Stroke	Spindle pitch	Part no.	Type
	250 mm	3 mm/U	5428866	EPCC-BS-45-250-3P-A
		10 mm/U	5428876	EPCC-BS-45-250-10P-A
	300 mm	3 mm/U	5428867	EPCC-BS-45-300-3P-A
		10 mm/U	5428877	EPCC-BS-45-300-10P-A

EPCC-BS-60				
	Stroke	Spindle pitch	Part no.	Type
	25 mm	5 mm/U	★ 5428888	EPCC-BS-60-25-5P-A
		12 mm/U	★ 5428901	EPCC-BS-60-25-12P-A
	50 mm	5 mm/U	★ 5428889	EPCC-BS-60-50-5P-A
		12 mm/U	★ 5428902	EPCC-BS-60-50-12P-A
	75 mm	5 mm/U	5428890	EPCC-BS-60-75-5P-A
		12 mm/U	5428903	EPCC-BS-60-75-12P-A
	100 mm	5 mm/U	★ 5428891	EPCC-BS-60-100-5P-A
		12 mm/U	★ 5428904	EPCC-BS-60-100-12P-A
	125 mm	5 mm/U	5428892	EPCC-BS-60-125-5P-A
		12 mm/U	5428905	EPCC-BS-60-125-12P-A
	150 mm	5 mm/U	★ 5428893	EPCC-BS-60-150-5P-A
		12 mm/U	★ 5428906	EPCC-BS-60-150-12P-A
	175 mm	5 mm/U	5428894	EPCC-BS-60-175-5P-A
		12 mm/U	5428907	EPCC-BS-60-175-12P-A
	200 mm	5 mm/U	★ 5428895	EPCC-BS-60-200-5P-A
		12 mm/U	★ 5428908	EPCC-BS-60-200-12P-A
	250 mm	5 mm/U	★ 5428896	EPCC-BS-60-250-5P-A
		12 mm/U	★ 5428909	EPCC-BS-60-250-12P-A
	300 mm	5 mm/U	★ 5428897	EPCC-BS-60-300-5P-A
		12 mm/U	★ 5428910	EPCC-BS-60-300-12P-A
350 mm	5 mm/U	5428898	EPCC-BS-60-350-5P-A	
	12 mm/U	5428911	EPCC-BS-60-350-12P-A	
400 mm	5 mm/U	5428899	EPCC-BS-60-400-5P-A	
	12 mm/U	5428912	EPCC-BS-60-400-12P-A	
500 mm	5 mm/U	5428900	EPCC-BS-60-500-5P-A	
	12 mm/U	5428913	EPCC-BS-60-500-12P-A	

Ordering information – Modular product system					Further information → epcc
	Size	Stroke	Spindle pitch	Part no.	Type
	25	25 ... 200 mm	2 ... 6 mm/U	5428821	EPCC-BS-25-
	32		3 ... 8 mm/U	5428849	EPCC-BS-32-
	45	25 ... 300 mm	3 ... 10 mm/U	5428878	EPCC-BS-45-
	60	25 ... 500 mm	5 ... 12 mm/U	5428914	EPCC-BS-60-

Peripherals

Peripherals overview

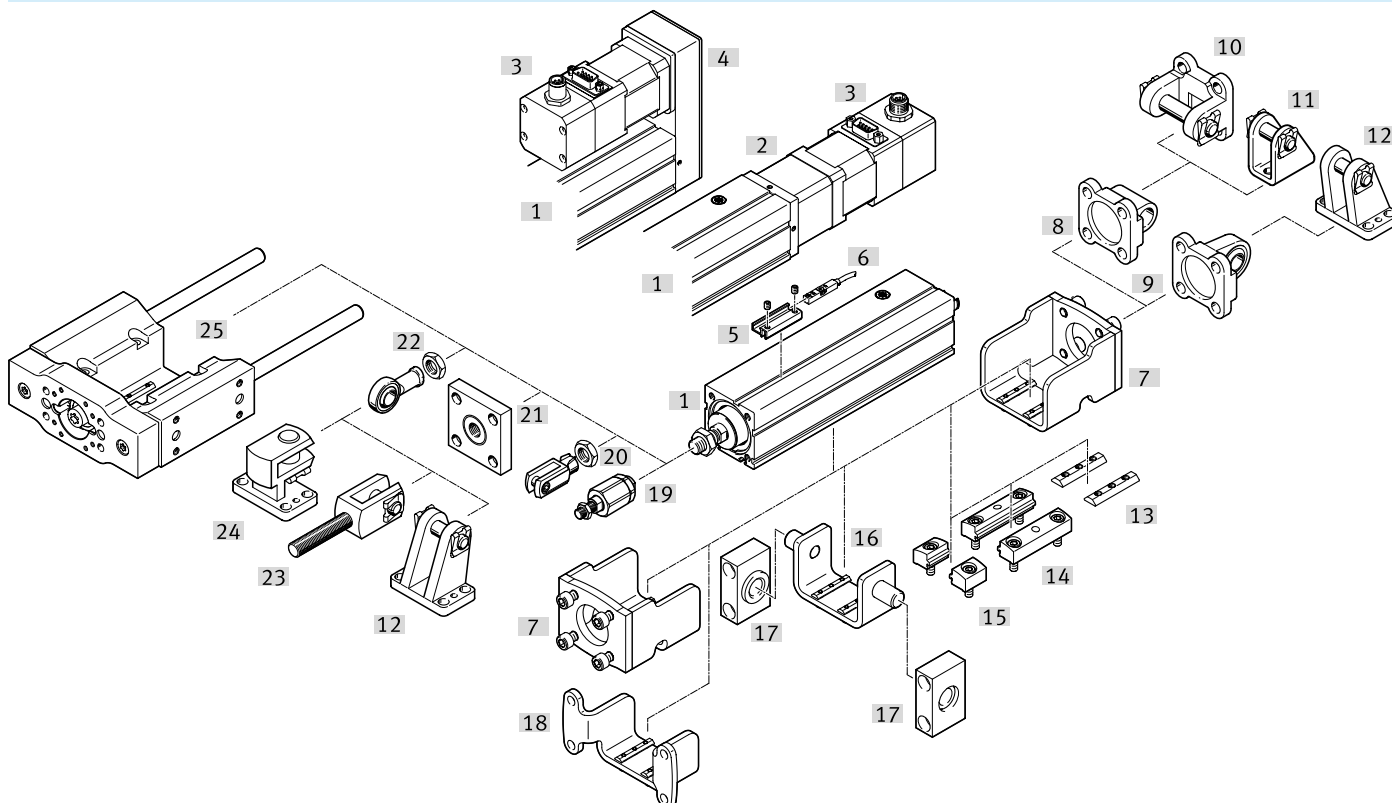

Accessories		→ Page/Internet
Type/order code	Description	
[1] Electric cylinder EPCC	Electric drive	epcc
[2] Axial kit EAMM-A	For axial motor mounting	eamm-a
[3] Motor EMMT-AS	Motors and kits specially matched with the axis Detailed information: www.festo.com/catalogue/eamm Engineering tool: www.festo.com/x/electric-motion-sizing	emmt-as
[3] Motor EMME-AS	Motors and kits specially matched with the axis Detailed information: www.festo.com/catalogue/eamm Engineering tool: www.festo.com/x/electric-motion-sizing	emme-as
[3] Motor EMMS-ST	Motors and kits specially matched with the axis Detailed information: www.festo.com/catalogue/eamm Engineering tool: www.festo.com/x/electric-motion-sizing	emms-st
[4] Parallel kit EAMM-U	For parallel motor mounting	eamm-u
[5] Sensor bracket EAPM-L2	For mounting the proximity switches on the axis. The proximity switches can only be mounted using the sensor bracket	35
[6] Proximity switches SMT-8M	Magnetic proximity switches, for T-slot	35
[7] Adapter kit EAHA-P2	- For mounting the swivel flange and trunnion flange on the front - Can only be mounted on the rear in conjunction with parallel kit EAMM-U	32
[8] Swivel flange SNCL	With parallel motor mounting	33
[9] Swivel flange SNCS	With parallel motor mounting	32
[10] Swivel flange SNCB	For parallel motor mounting, for spherical bearing	33
[11] Clevis foot LBN	For parallel motor mounting, for spherical bearing	
[12] Clevis foot LBG/LBG-...-R3	For parallel motor mounting, for spherical bearing	33
[13] Slot nut ABAN	For mounting the electric cylinder	35
[14] Profile mounting EAHF-L2-P	- For mounting the axis on the side of the profile - The hole in the middle allows the profile mounting to be attached to the mounting surface	32
[15] Profile mounting EAHF-L2-P-S	For mounting the axis on the side of the profile	32
[16] Swivel mounting EAHS-P2	Position freely selectable along the cylinder length	32
[17] Trunnion support LNZG	For cylinders with trunnion mounting	32
[18] Flange mounting EAHH-P2	- For mounting the electric cylinder via the profile - Position within the cylinder length freely selectable	32
[19] Self-aligning rod coupler FK/CRFK	To compensate for radial and angular deviations	34
[20] Rod clevis SG/CRSG	Allows a swivelling movement of the cylinder in one plane	34

Peripherals

Accessories		→ Page/Internet
Type/order code	Description	
[21] Coupling piece KSG	To compensate for radial deviations	34
[22] Rod eye SGS/CRSGS	With spherical bearing	34
[23] Rod clevis SGA	For swivelling cylinder mounting	34
[24] Right angle clevis foot LQG	For rod eye SGS	33
[25] Guide unit EAGF	For protecting electric cylinders against rotation at high torque loads	35

Accessories

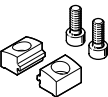
Profile mounting EAHF-L2-...-P-S						
	Description	Material plate	Note on materials	Product weight	Part no.	Type
	For sizes 25 and 32	Anodised wrought aluminium alloy	RoHS-compliant	4 g	5183153	EAHF-L2-25-P-S
	For size 45, 60			6 g	5184133	EAHF-L2-45-P-S

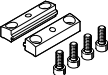
Profile mounting EAHF-L2-...-P						
	Description	Material plate	Note on materials	Product weight	Part no.	Type
	For sizes 25 and 32	Anodised wrought aluminium alloy	RoHS-compliant	19 g	4835684	EAHF-L2-25-P
	For size 45, 60			35 g	4835728	EAHF-L2-45-P

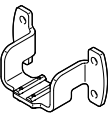
Flange mounting EAHH						
	Description	Note on materials	Product weight	Part no.	Type	
	For size 25	RoHS-compliant	65 g	5127286	EAHH-P2-25	
	For size 32		80 g	5126157	EAHH-P2-32	
	For size 45		185 g	5126669	EAHH-P2-45	
	For size 60		320 g	5127005	EAHH-P2-60	

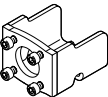
Adapter kit EAHA						
	Description	Note on materials	Product weight	Part no.	Type	
	For size 25	RoHS-compliant	110 g	5172843	EAHA-P2-25	
	For size 32		165 g	5173020	EAHA-P2-32	
	For size 45		340 g	5172353	EAHA-P2-45	
	For size 60		560 g	5173082	EAHA-P2-60	

Swivel mounting EAHS						
	Description	Note on materials	Product weight	Part no.	Type	
	For size 25	RoHS-compliant	70 g	5125383	EAHS-P2-25	
	For size 32		75 g	5125041	EAHS-P2-32	
	For size 45		165 g	5125167	EAHS-P2-45	
	For size 60		305 g	5125281	EAHS-P2-60	

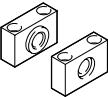
Trunnion support LNZG						
	Description	Material mounting	Note on materials	Product weight	Part no.	Type
	For sizes 25 and 32	Wrought aluminium alloy	RoHS-compliant	26 g	1434912	LNZG-16
	For size 45			83 g	32959	LNZG-32
	For size 60			129 g	32960	LNZG-40/50

Swivel flange SNCS						
	Description	Material mounting	Note on materials	Product weight	Part no.	Type
	For size 45	Die-cast aluminium	RoHS-compliant	86 g	★ 174397	SNCS-32

Accessories

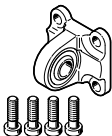
Swivel flange SNCS						
	Description	Material mounting	Note on materials	Product weight	Part no.	Type
	For size 60	Die-cast aluminium	RoHS-compliant	122 g	★ 174398	SNCS-40

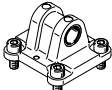
Swivel flange SNCL						
	Description	Material mounting	Note on materials	Product weight	Part no.	Type
	For size 25	Wrought aluminium alloy	RoHS-compliant	21 g	537791	SNCL-16
	For size 32			38 g	537792	SNCL-20
	For size 45	Die-cast aluminium		71 g	★ 174404	SNCL-32
	For size 60			95 g	★ 174405	SNCL-40

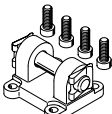
Swivel flange SNCB						
	Description	Material mounting	Note on materials	Product weight	Part no.	Type
	For size 45	Die-cast aluminium	RoHS-compliant	103 g	★ 174390	SNCB-32
	For size 60			155 g	★ 174391	SNCB-40

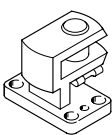
Clevis foot transverse LQG						
	Description	Material mounting	Note on materials	Product weight	Part no.	Type
	For size 45	Stainless steel casting	RoHS-compliant	301 g	31768	LQG-32
	For size 60			369 g	31769	LQG-40

Clevis foot LBN						
	Description	Material mounting	Note on materials	Product weight	Part no.	Type
	For size 25	Steel, Galvanised	RoHS-compliant	40 g	★ 6058	LBN-12/16
	For size 32			84 g	★ 6059	LBN-20/25

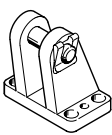
Clevis foot LBG						
	Description	Material mounting	Note on materials	Product weight	Part no.	Type
	For size 45	Stainless steel casting	RoHS-compliant	220 g	31761	LBG-32

Accessories

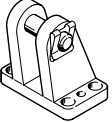
Clevis foot LBG						
	Description	Material mounting	Note on materials	Product weight	Part no.	Type
	For size 60	Stainless steel casting	RoHS-compliant	300 g	31762	LBG-40

Rod eye SGS						
	Description	Material housing	Note on materials	Product weight	Part no.	Type
	For size 25	Galvanised steel	RoHS-compliant	30 g	★ 9254	SGS-M6
	For size 32			54 g	★ 9255	SGS-M8
	For size 45			88 g	★ 9261	SGS-M10X1,25
	For size 60			130 g	★ 9262	SGS-M12X1,25

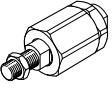
Self-aligning rod coupler FK						
	Description	Material housing	Note on materials	Product weight	Part no.	Type
	For size 25	Steel, Galvanised	RoHS-compliant	23 g	★ 2061	FK-M6
	For size 32			50 g	★ 2062	FK-M8
	For size 45			210 g	★ 6140	FK-M10X1,25
	For size 60			215 g	★ 6141	FK-M12X1,25

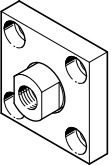
Coupling piece KSG						
	Description	Material mounting	Note on materials	Product weight	Part no.	Type
	For size 45	Steel, Galvanised	RoHS-compliant	229 g	32963	KSG-M10X1,25
	For size 60			447 g	32964	KSG-M12X1,25

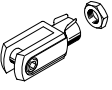
Rod clevis SG						
	Description	Material housing	Note on materials	Product weight	Part no.	Type
	For size 25		RoHS-compliant	22 g	★ 3110	SG-M6
	For size 32			53 g	★ 3111	SG-M8
	For size 45			103 g	★ 6144	SG-M10X1,25
	For size 60			166 g	★ 6145	SG-M12X1,25

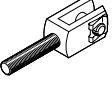
Rod clevis SGA						
	Description	Material housing	Note on materials	Product weight	Part no.	Type
	For size 45		RoHS-compliant	129 g	32954	SGA-M10X1,25
	For size 60			222 g	10767	SGA-M12X1,25

Push-in fitting for sealing air connection						
	Description	Material housing	Size of pack	Product weight	Part no.	Type
	For size 25, 32	Brass, nickel-plated	10	3 g	133004	QSM-M5-4-I-R

Accessories

Push-in fitting for sealing air connection						
	Description	Material housing	Size of pack	Product weight	Part no.	Type
	For size 25, 32	Brass, nickel-plated	10	3.2 g	133003	QSM-M5-3-I-R
	For size 45			8.9 g	★ 186266	QSM-G1/8-4-I
				9.5 g	★ 186267	QSM-G1/8-6-I
	For size 60			13 g	★ 186108	QS-G1/4-6-I
				14 g	★ 186110	QS-G1/4-8-I

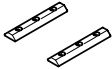
Slot nut ABAN					
	Material slot nut	Size of pack	Product weight	Part no.	Type
	Steel	2	5 g	8169987	ABAN-3-3M3-30-M-P2
			18 g	8169988	ABAN-5-3M5-40-M-P2

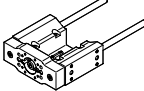
Guide unit EAGF					
	Size	Stroke	Part no.	Type	
	32	1 ... 200 mm	8158030	EAGF-P2-KF-32-	
		50 mm	8158032	EAGF-P2-KF-32-50	
		100 mm	8158029	EAGF-P2-KF-32-100	
		150 mm	8158027	EAGF-P2-KF-32-150	
		200 mm	8158028	EAGF-P2-KF-32-200	
	45	1 ... 300 mm	8158133	EAGF-P2-KF-45-	
		50 mm	8158131	EAGF-P2-KF-45-50	
		100 mm	8158123	EAGF-P2-KF-45-100	
		150 mm	8158125	EAGF-P2-KF-45-150	
		200 mm	8158127	EAGF-P2-KF-45-200	
	60	300 mm	8158130	EAGF-P2-KF-45-300	
		1 ... 500 mm	8158150	EAGF-P2-KF-60-	
		100 mm	8158138	EAGF-P2-KF-60-100	
		150 mm	8158140	EAGF-P2-KF-60-150	
		200 mm	8158142	EAGF-P2-KF-60-200	
		300 mm	8158031	EAGF-P2-KF-60-300	

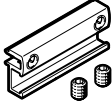
Sensor bracket EAPM-L2					
	Material sensor bracket	Note on materials	Product weight	Part no.	Type
	Anodised wrought aluminium alloy	RoHS-compliant	4 g	★ 4759852	EAPM-L2-SH

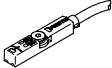
Proximity switch SMT for T-slot, magneto-resistive						Further information → smt-8m
	Type of mounting	Switching output	Electrical connection	Cable length	Part no.	Type
	Screw-clamped, insertable in the slot from above	3-wire N/C contact NPN	Open end	2.5 m	8138000	SMT-8M-A-NO-24V-E-2,5-OE
				7.5 m	8138001	SMT-8M-A-NO-24V-E-7,5-OE
		3-wire NPN N/O contact	Plug M8, A-coded	2.5 m	★ 574338	SMT-8M-A-NS-24V-E-2,5-OE
				0.3 m	★ 574339	SMT-8M-A-NS-24V-E-0,3-M8D
		3-wire PNP N/C contact	Open end	7.5 m	★ 574340	SMT-8M-A-PO-24V-E-7,5-OE
				2.5 m	★ 574335	SMT-8M-A-PS-24V-E-2,5-OE
		3-wire PNP N/O contact	Plug M8, A-coded	2.5 m	★ 574334	SMT-8M-A-PS-24V-E-0,3-M8D
				0.3 m	★ 574334	SMT-8M-A-PS-24V-E-0,3-M8D

Accessories

Connecting cables NEBU, straight

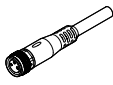
	Electrical connection 1, connector system	Electrical connection 2, connector system	Electrical connection 2, number of connections/cores	Cable length	Part no.	Type
	M8x1, A-coded, to EN 61076-2-104	Open end	3	2.5 m	541333	NEBU-M8G3-K-2.5-LE3
				5 m	541334	NEBU-M8G3-K-5-LE3

Connecting cables NEBU, angled

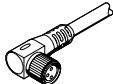
	Electrical connection 1, connector system	Electrical connection 2, connector system	Electrical connection 2, number of connections/cores	Cable length	Part no.	Type
	M8x1, A-coded, to EN 61076-2-104	Open end	3	2.5 m	541338	NEBU-M8W3-K-2.5-LE3
				5 m	541341	NEBU-M8W3-K-5-LE3