

## MSP430-H2618 development board

### Users Manual



All boards produced by Olimex are RoHS compliant

Rev. Initial, April 2009

Copyright(c) 2009, OLIMEX Ltd, All rights reserved

## **INTRODUCTION:**

MSP430-H2618 header board provides easy way for developing and prototyping with the new mixed signal MSP430F2618 microcontroller. It has JTAG interface and most of the GPIOs are on extension headers where you can connect your additional circuits.

## **BOARD FEATURES:**

- MCU: MSP430F2618 with 116 KB + 256 B Flash Memory, 8 KB RAM
- JTAG connector
- 32 768 Hz oscillator crystal
- Optional high frequency crystal (socket)
- Extension headers for all microcontroller pins
- PCB: FR-4, 1.5 mm (0.062"), green soldermask, silkscreen component print
- Dimensions 46.99 x 46.99 mm (1.850 x 1.850")

## **ELECTROSTATIC WARNING:**

The **MSP430-H2618** board is shipped in protective anti-static packaging. The board must not be subject to high electrostatic potentials. General practice for working with static sensitive devices should be applied when working with this board.

## **BOARD USE REQUIREMENTS:**

- Cables:** The cable you will need depends on the programmer/debugger you use. If you use MSP430-JTAG, you will need LPT cable. You will need 1.8 meter USB A-B cable to connect MSP430-JTAG-ISO or MSP430-JTAG-TINY to a USB host on your PC. If you use MSP430-JTAG-RF, you will not need a cable.
- Hardware:** Programmer/Debugger - one of the Olimex MSP430-JTAG tools: **MSP430-JTAG, MSP430-JTAG-ISO, MSP430-JTAG-TINY, MSP430-JTAG-RF.**
- Software:** **Olimex MSP430 programmer** - free stand-alone software which allows you to program MSP430 devices without any third party software; **MSP430 Kick Start C** compiler and debugger (free for assembly, limited for C); **MSPGCC** - free compiler and debugger. You will also need **drivers** for the JTAG programmer that you use (to be found on the corresponding web pages on our web site).

## PROCESSOR FEATURES:

**MSP430-H2618** board uses MCU **MSP430F2618** from Texas Instruments with these features:

- Low Supply Voltage Range, 1.8 V to 3.6 V
- Ultra-Low Power Consumption:
  - Active Mode: 365  $\mu$ A at 1 MHz, 2.2 V
  - Standby Mode: 0.5  $\mu$ A
  - Off Mode (RAM Retention): 0.1  $\mu$ A
- Wake-Up From Standby Mode in Less Than 1 $\mu$ s
- 16-Bit RISC Architecture, 62.5-ns Instruction Cycle Time
- Three-Channel Internal DMA
- 12-Bit Analog-to-Digital (A/D) Converter With Internal Reference, Sample-and-Hold, and Autoscan Feature
- Dual 12-Bit Digital-to-Analog (D/A) Converters With Synchronization
- 16-Bit Timer\_A With Three Capture/Compare Registers
- 16-Bit Timer\_B With Seven Capture/Compare-With-Shadow Registers
- On-Chip Comparator
- Four Universal Serial Communication Interfaces (USCIs)
  - USCI\_A0 and USCI\_A1
    - Enhanced UART Supporting Auto-Baudrate Detection
    - IrDA Encoder and Decoder
    - Synchronous SPI
  - USCI\_B0 and USCI\_B1
    - I<sup>2</sup>C
    - Synchronous SPI
- Supply Voltage Supervisor/Monitor With Programmable Level Detection
- Brownout Detector
- Bootstrap Loader
- Serial Onboard Programming, No External Programming Voltage Needed
- Programmable Code Protection by Security Fuse
- 116KB+256B Flash Memory, 8KB RAM

# BLOCK DIAGRAM:

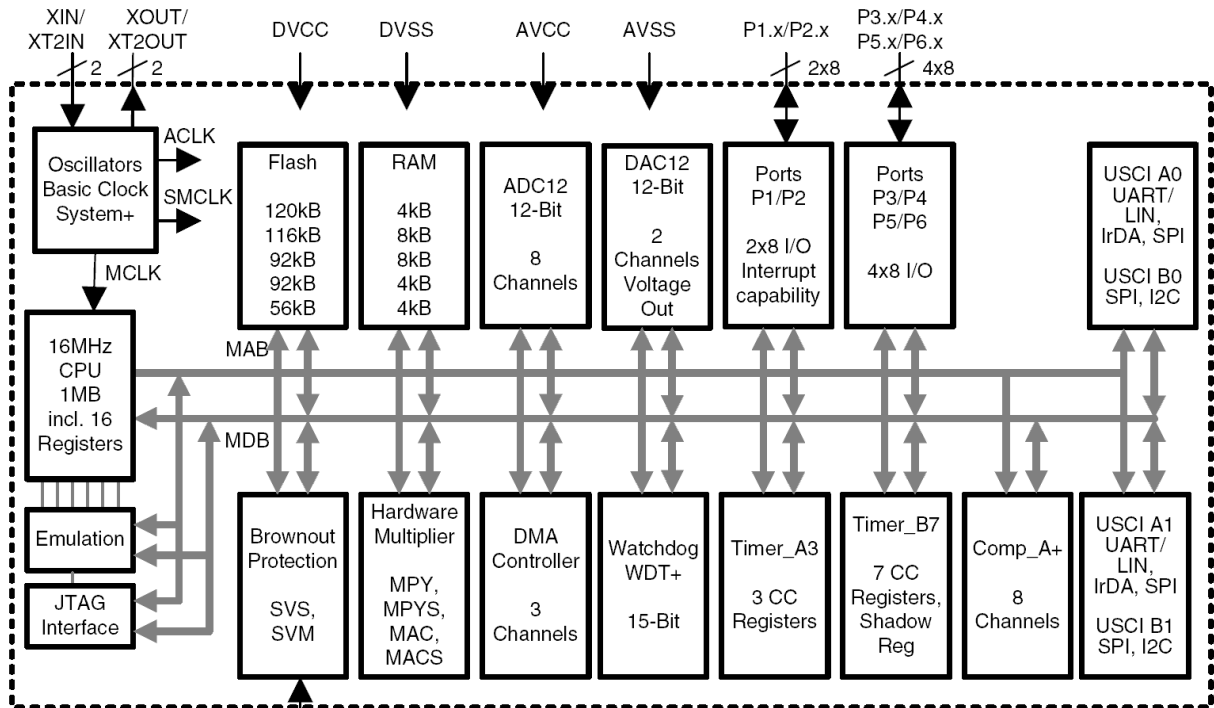

**MEMORY MAP:**

		<b>MSP430F2618</b>
Memory	Size	116KB
Main: interrupt vector	Flash	0x0FFFF - 0x0FFC0
Main: code memory	Flash	0x1FFFF - 0x03100
RAM (total)	Size	8kB
Extended	Size	0x030FF - 0x01100 6kB
Mirrored	Size	0x030FF - 0x01900 2kB
Information memory	Size	256 Byte
	Flash	0x010FF - 0x01000
Boot memory	Size	1KB
	ROM	0x00FFF - 0x00C00
RAM (mirrored at 0x18FF to 0x01100)	Size	2KB
		0x009FF - 0x00200
Peripherals	16-bit	0x001FF - 0x00100
	8-bit	0x000FF - 0x00010
	8-bit SFR	0x0000F - 0x00000

**SCHEMATIC:**

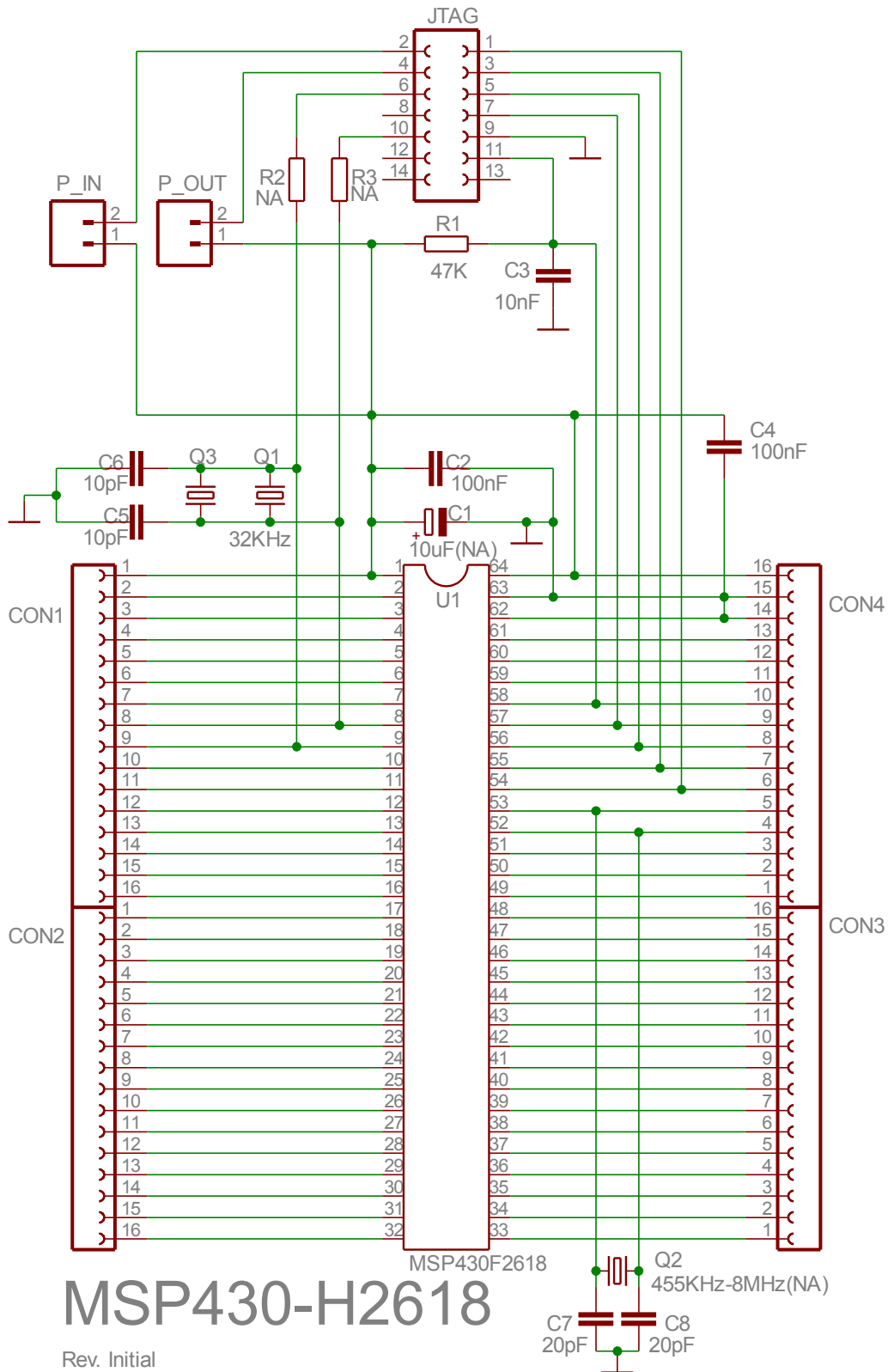

## BOARD LAYOUT:

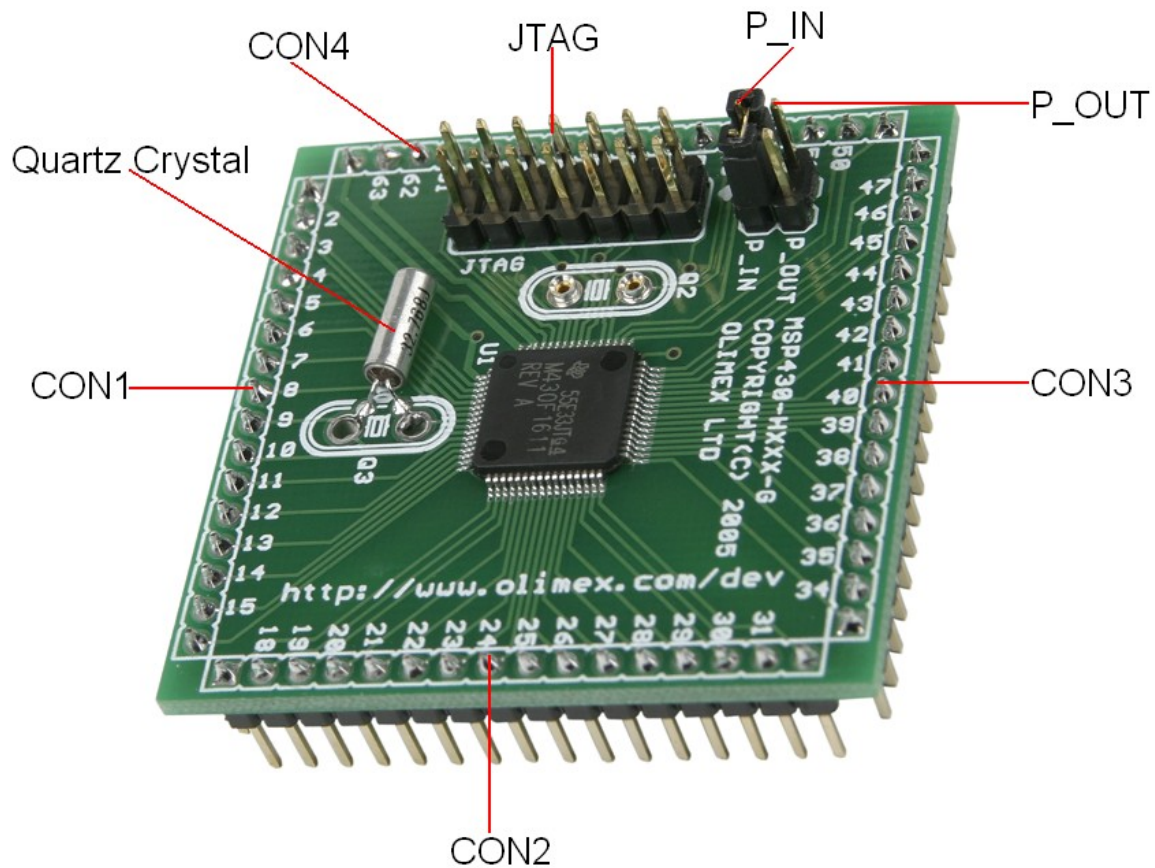

## POWER SUPPLY CIRCUIT:

MSP430-H2618 is typically power supplied from the JTAG interface (P\_IN closed). If not, you could power supply the board if you apply up to +3.6VDC at CON1 pin 1 (MSP430F2618.pin 1) and GND at CON4 pin 14 or pin 15 (MSP430F2618.pin 62 or 63).

The board power consumption is less than 10 mA.

## RESET CIRCUIT:

**MSP430-H2618** reset circuit is realized with a pull-up resistor R1 (47k) and capacitor C3(10n). You could also reset the MCU with an active low level at the JTAG pin 11 or at CON4 pin 10 (MSP430F2618.pin 58).

## CLOCK CIRCUIT:

Quartz crystal 32 768 Hz is connected to **MSP430F2618** pin 8 (XIN) and pin 9 (XOUT/TCLK).

There is an option for a high speed crystal oscillator to be connected to the **MSP430F2618** pin 52 (XT2OUT) and pin 53 (XT2IN).

## JUMPER DESCRIPTION:



When this jumper is closed, the board is power supplied by the standard JTAG pin 2. This is only possible when the consumption of the board is not very high which is typically the case with MSP430 microcontrollers. If this jumper is open the board should be power supplied by another external source. This jumper and P\_OUT should always be reversely open/closed, i.e. if P\_IN is closed, P\_OUT should be open and vice versa.

Default state is closed.



When this jumper is closed, the board is power supplied not by the JTAG but from external source. Then the JTAG has to synchronize with the working voltages which is done through this line. This is especially important when debugging with JTAG. This jumper and P\_IN should always be reversely open/closed, i.e. if P\_OUT is closed, P\_IN should be open and vice versa.

Default state is open.



## EXTERNAL CONNECTORS DESCRIPTION:

### JTAG:

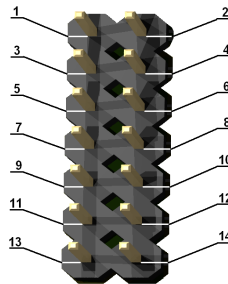

Pin #	Signal Name	Pin#	Signal Name
1	TDO	2	P_IN
3	TDI	4	P_OUT
5	TMS	6	NC
7	TCK	8	NC
9	GND	10	NC
11	RST	12	NC
13	NC	14	NC

**TDI** Input **Test Data In.** This is the serial data input for the shift register.

**TDO** Output **Test Data Out.** This is the serial data output for the shift register. Data is shifted out of the device on the negative edge of the TCK signal.

**TMS** Input **Test Mode Select.** The TMS pin selects the next state in the TAP state machine.

**TCK** Input **Test Clock.** This allows shifting of the data in, on the TMS and TDI pins. It is a positive edge triggered clock with the TMS and TCK signals that define the internal state of the device.

**P\_IN** Input **Power In.** Normally, if there isn't external power source, this signal power supplies the board.

**P\_OUT** Output **Power Out.** When there is external power supply, this is the voltage synchronization signal for the JTAG interface.

**CON1:**

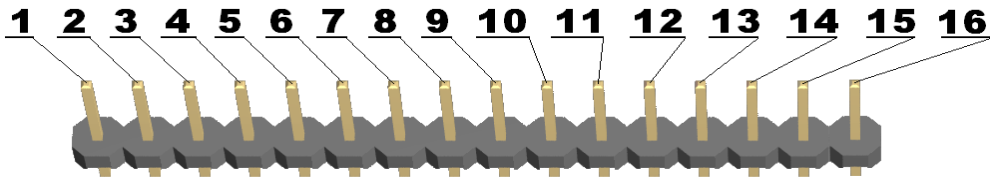

Pin #	Signal Name	Pin#	Signal Name
1 (1)	DV <sub>CC1</sub>	2 (2)	P6.3/A3
3 (3)	P6.4/A4	4 (4)	P6.5/A5/DAC1
5 (5)	P6.6/A6/DAC0	6 (6)	P6.7/A7/DAC1/SVSIN
7 (7)	V <sub>REF+</sub>	8 (8)	XIN
9 (9)	XOUT	10 (10)	V <sub>REF+</sub> /DAC0
11 (11)	V <sub>REF-</sub> /V <sub>REF-</sub>	12 (12)	P1.0/TACLK/CAOUT
13 (13)	P1.1/TA0	14 (14)	P1.2/TA1
15 (15)	P1.3/TA2	16 (16)	P1.4/SMCLK

**CON2:**

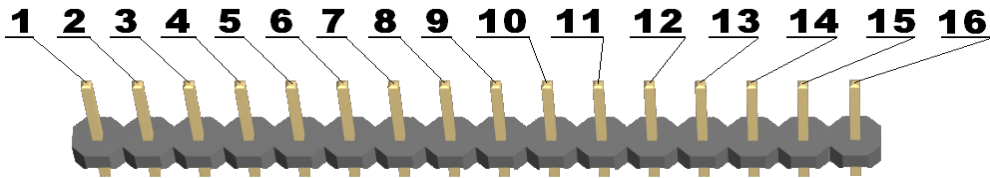

Pin #	Signal Name	Pin#	Signal Name
1 (17)	P1.5/TA0	2 (18)	P1.6/TA1
3 (19)	P1.7/TA2	4 (20)	P2.0/ACLK/CA2
5 (21)	P2.1/TAINCLK/CA3	6 (22)	P2.2/CAOUT/TA0/CA4
7 (23)	P2.3/CA0/TA1	8 (24)	P2.4/CA1/TA2
9 (25)	P2.5/Rosc/CA5	10 (26)	P2.6/ADC12CLK/CA6
11 (27)	P2.7/TA0/CA7	12 (28)	P3.0/UCB0STE
13 (29)	P3.1/UCB0SIMO/UCB0SD	14 (30)	P3.2/UCB0SOMI/UCB0SC

	A		L
15 (31)	P3.3/UCB0CLK/UCA0STE	16 (32)	P3.4/UCA0TXD

**UCB0CLK I/O** Universal Serial Communication Interface (USCI) B0 clock input/output.  
**UCB0SOMI I/O** USCI B0 slave out/master in in SPI mode.  
**UCB0SIMO I/O** USCI B0 slave in/master out in SPI mode.  
**UCB0STE I/O** USCI B0 slave transmit enable.  
**UCA0TXD Output** USCIA transmit data output in UART mode.  
**UCB0SDA I/O** SDA I<sup>2</sup>C data in I<sup>2</sup>C mode.  
**USB0SCL I/O** SCL I<sup>2</sup>C clock in I<sup>2</sup>C mode.

### CON3:

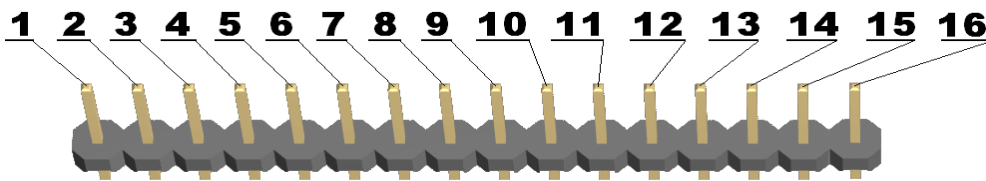

Pin #	Signal Name	Pin#	Signal Name
1 (33)	P3.5/UCA0RXD	2 (34)	P3.6/UCA1TXD
3 (35)	P3.7/UCA1RXD	4 (36)	P4.0/TB0
5 (37)	P4.1/TB1	6 (38)	P4.2/TB2
7 (39)	P4.3/TB3	8 (40)	P4.4/TB4
9 (41)	P4.5/TB5	10 (42)	P4.6/TB6
11 (43)	P4.7/TBCLK	12 (44)	P5.0/UCB1STE
13 (45)	P5.1/UCB1SIMO	14 (46)	P5.2/UCB1SOMI
15 (47)	P5.3/UCB1CLK	16 (48)	P5.4/MCLK

**UCA0RXD Input** USCI A0 receive data input in UART mode, slave data out.  
**UCB1CLK I/O** USCI B1 clock input/output.  
**UCB1SOMI I/O** USCI B1 slave out/master in in SPI mode.  
**UCB1SIMO I/O** USCI B1 slave in/master out in SPI mode.  
**UCB1STE I/O** USCI B1 slave transmit enable.  
**UCA1TXD Output** USCI A1 transmit data output in UART mode.  
**UCA1RXD Input** USCI A1 receive data input in UART mode.

**CON4:**

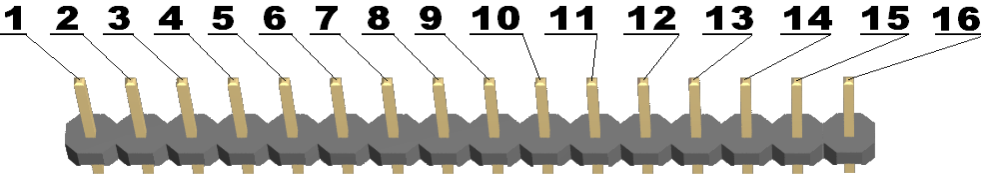

Pin #	Signal Name	Pin#	Signal Name
1 (49)	P5.5/SMCLK	2 (50)	P5.6/ACLK
3 (51)	P5.7/TBOUTH/SVSOUT	4 (52)	XT2OUT
5 (53)	XT2IN	6 (54)	TDO/TDI
7 (55)	TDI/TCLK	8 (56)	TMS
9 (57)	TCK	10 (58)	#RST/NMI
11 (59)	P6.0/A0	12 (60)	P6.1/A1
13 (61)	P6.2/A2	14 (62)	AV <sub>SS</sub>
15 (63)	DV <sub>SS1</sub>	16 (64)	AV <sub>CC</sub>

**MECHANICAL DIMENSIONS:**

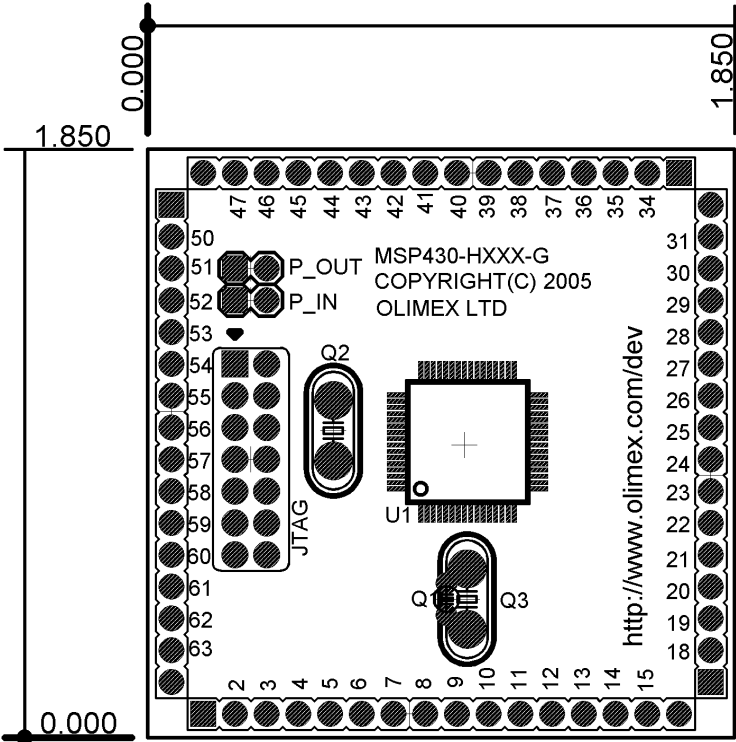

- All measures are in inches.

## **AVAILABLE DEMO SOFTWARE:**

- MSP430-H2618\_Blinking\_Led

You could find MSP430-H2618 demo software at [www.olimex.com/dev](http://www.olimex.com/dev).

## **ORDER CODE:**

MSP430-H2618 – assembled and tested (no kit, no soldering required).

How to order?

You can order to us directly or by any of our distributors.

Check our web [www.olimex.com/dev](http://www.olimex.com/dev) for more info.

## **Revision history:**

REV. Initial    - created    April 2009

**Disclaimer:**

© 2009 Olimex Ltd. All rights reserved. Olimex®, logo and combinations thereof, are registered trademarks of Olimex Ltd. Other terms and product names may be trademarks of others.

The information in this document is provided in connection with Olimex products. No license, express or implied or otherwise, to any intellectual property right is granted by this document or in connection with the sale of Olimex products.

Neither the whole nor any part of the information contained in or the product described in this document may be adapted or reproduced in any material from except with the prior written permission of the copyright holder.

The product described in this document is subject to continuous development and improvements. All particulars of the product and its use contained in this document are given by OLIMEX in good faith. However all warranties implied or expressed including but not limited to implied warranties of merchantability or fitness for purpose are excluded.

This document is intended only to assist the reader in the use of the product. OLIMEX Ltd. shall not be liable for any loss or damage arising from the use of any information in this document or any error or omission in such information or any incorrect use of the product.