

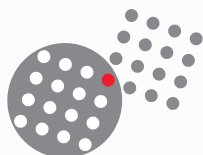

UTS Series

Dynamic IP68/69K • UV Resistant • UL/IEC Compliant



SOURIAU
Connection Technology



Contents

Overview

How to read our catalogue	06
UTS range overview	07
General technical characteristics	10
UTS layout guide	12
Contacts layout	13
De-rating curves	14

Mechanics

UTS plug cable gland backshell	24
UTS square flange receptacle	26
UTS jam nut receptacle with accessories	28
Solder tail protrusion	30
UTS in-line receptacle with accessories	32
Accessories	34
Cable assembly	36

Contacts

Description	40
Contact plating selector guide	41
Contact selector guide	42
Packaging	42
Crimp contacts	43
Coaxial contacts	45
PCB contacts	46
Fibre optic contacts	47

Technical information

Tooling	52
Assembly instruction	54
Rated current & working voltage	58
UV resistance	59
Crimping	59
UL94 + UL1977	60
IEC 61984 with IP code explanation	63
What is NEMA rating ?	65

Annexes

Coaxial contacts - cabling notices	68
Glossary of terms	75
Coordinates for PC tail terminations	76
Stand off dimensions - Drilling pattern	78
Discrimination/Keying methods	79

UNIT'S Series



UTS Series

Overview

■ How to read our catalogue	06
■ UTS range overview	07
■ General technical characteristics	10
■ UTS layout guide	12
■ Contacts layout	13
■ De-rating curves	14



UTS Series



How to read our catalog

Example:

A 3 x 1.5mm² multicore cable carrying 10A of continuous current needs to be connected to a weatherproof enclosure.

The enclosure contains some expensive electronics, so it is important to ensure that it remains sealed even when the cable is not connected.

Step 1

Use the layout guide page 12.



UTS Layout Guide

Contact quantity	Shell size	Wire dimension & Contacts size		
		AWG 22 to 12 0.13 to 4 mm ²	AWG 26 to 18 0.13 to 0.93 mm ²	AWG 30 to 14 0.05 to 2.5 mm ²
2	8		8E2 (Solder) 8D2 (PCB)	10E2 (Solder) 10D2 (PCB)
	12			12E2 (Solder) 12D2 (PCB)
2 + PE	10			10E3 (Solder) 10D3 (PCB)
	12		8E3, 8E3A, 8E98, 8E13 (Solder) 8D3, 8D3A, 8D98, 8D33 (PCB)	10E3 (Solder) 10D3 (PCB)
	14			14E3 (Solder) 14D3 (PCB)

→ **12E3** (for solder contacts)
or **12D3** (for PCB)

Step 2

Check if your layout can run at 10A continuous using the dedicated de-rating curve (see pages 14 to 20).

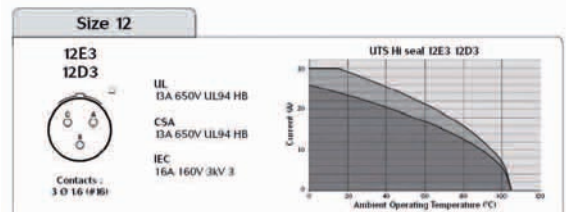

Step 3

Choose your plug and receptacle.

In our example we chose a plug with solder contacts.



Plug	Receptacle	Material	Notes
Solder contacts loaded	Female	UTS6JC - E - S	Sealed / Unsealed
	Male	UTS6JC - E - P	Sealed / Unsealed
	Female	UTS6JC - E - S	Sealed / Unsealed

Plug with solder contacts:
→ **UTS6JC - E - S**

Step 4

Your selection should be:

→ **UTS6JC - E - S**

Using the UTS layout guide you can select the insert arrangement code according to your needs. Replace -- by your choice → **12E3** for solder contacts.

Result:

Here your plug with solder contacts is **UTS6JC12E3S**

For any assembly questions please refer to the "assembly instruction" section (pages 54 to 57).

For discrimination see p.79.



UTS Series

UTS range overview

The UTS series is a plastic connector range but rugged enough to withstand industrial applications.

The bayonet coupling system makes it simple to use. With only a 1/3 twist of the coupling ring, connectors are mated with an audible and sensitive "click"

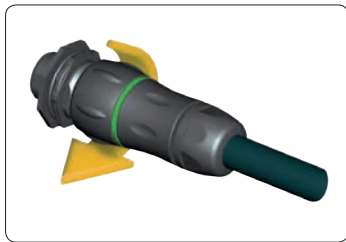

UTS series is a wide range...

Based on multiple power & signal connectors and offers everything from box mounted receptacles and cable mounted plugs to cable mounted in-line and PCB mounted receptacles. Almost all ways to accommodate wires exist: Crimp, Solder, Screw termination. We recently added the RJ45 version (Cat5e) to meet the increasing demand of networking.



Screw termination version

RJ45 version

The philosophy of the UTS series is built around three key elements:

Dynamic IP68/69K



UTS series is rated at IP68/69K... even in dynamic conditions. This means that it remain sealed even when used continuously underwater or cleaned using a high pressure hose and cable is moving.

This extreme level of performance is achievable with jacketed cable or discrete wires.

If this same level of performance is required even when connectors are not mated, we have UTS Hi Seal; a product designed to remain watertight if an environmental cap is not fitted or if the equipment is likely to get wet when cables have been disconnected.

UV Resistant



In most applications, our connectors are exposed to extreme climatic conditions; it was therefore key for us to select the materials best able to cope with the targeted environment.

Part of our product qualification process involved subjecting connectors to a simulated five years of exposure to various elements including Temperature, UV and Humidity.

The results were positive in that there were no visible signs of weakness, such as cracking or crazing.

UL/IEC Compliant



The utmost priority for any electrical installation is to protect personnel from any shock hazard.

In North America, Underwriters Laboratories insisted that connector manufacturers, depending of the application, respect their standards. The UTS series had thus been qualified and is certified by this organisation.

In Europe and in Asia, IEC standards are better known and trusted by end users. Like its American equivalent, the IEC refers to safety rules. The UTS series was obviously designed to respect these rules.



UTS range

UTS discrete wire sealing

See page 9

UTS Series



Sealed: IP68/69K
UV resistant
UL/IEC compliant



Corrosion-proof
Plastic housing

UTS screw termination



Just screw the wires to the connector !

No special tools required, use a standard screwdriver

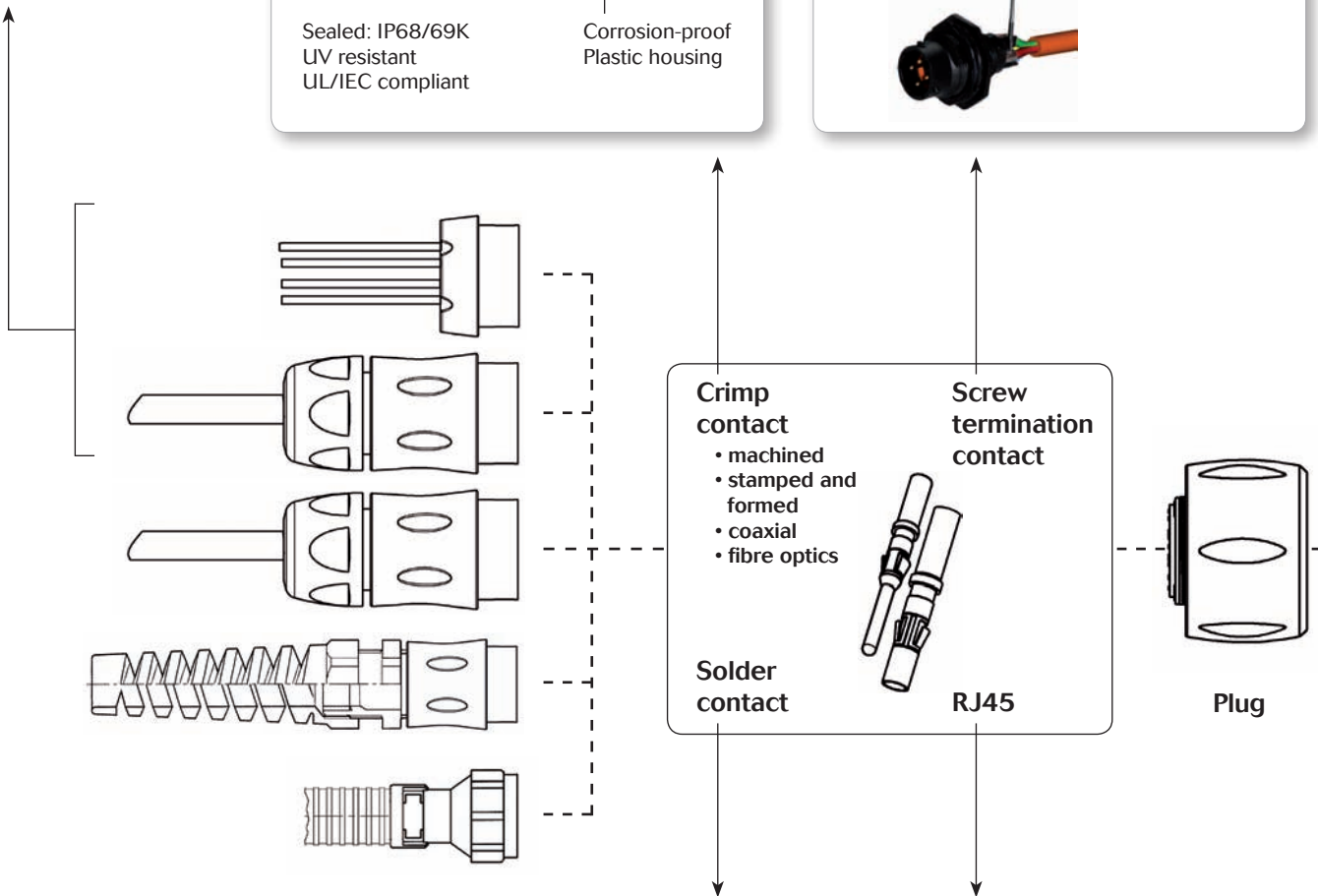

Crimp contact

- machined
- stamped and formed
- coaxial
- fibre optics

Solder contact

Screw termination contact



RJ45

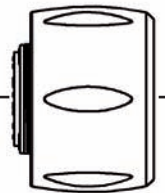

Plug

UTS Hi seal



Sealed unmated: IP68/69K
MIL-C-26482 compatible
UV resistant
UL/IEC compliant

Sealed Unmated



Corrosion-proof
Plastic housing

UTS RJ45

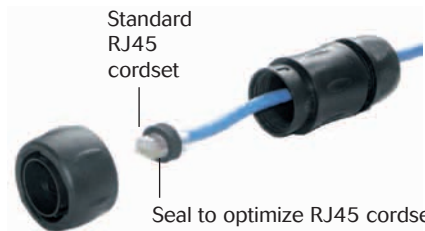

Standard
RJ45
cordset

Seal to optimize RJ45 cordset
positioning & vibration resistance



UTS Series

overview

Overview

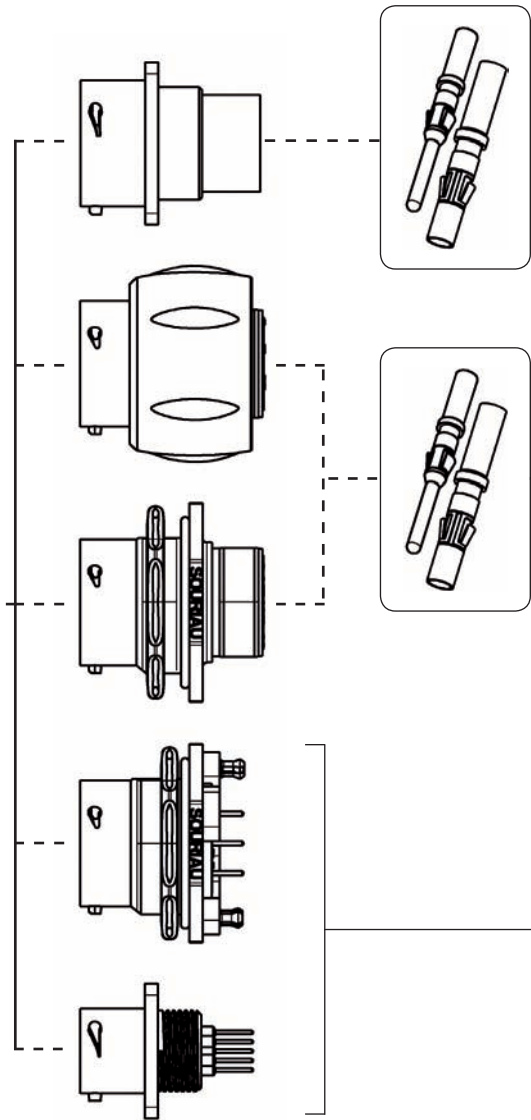

Receptacles

UTS discrete wire sealing

No filler plug needed

Grommet

Containment ring

Backnut or Easy handling backshell

Double Sealing

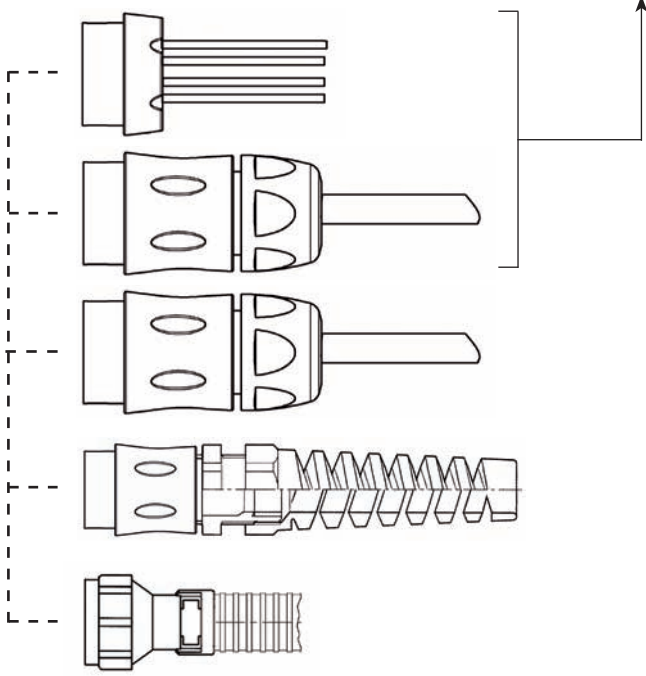

UTS PCB contacts

Stand-offs to allow cleaning after soldering

Low profile housing to limit space between panel and PCB

Metal hold down clips - to lock the connector easily on the PCB and to release stress on solder joints - suitable for soldering in a metalised hole

Pre-assembled PCB contacts - machined or stamped versions available - different solder tails lengths possible - different plating options

Mechanical

- Durability:
250 matings & unmatings per MIL-C-26482
- 1 • Vibration resistance (all UTS versions except UTS Screw termination contacts & UTS RJ45):
Sinusoidal vibrations per CEI 60512-4 - from 10 to 2000 Hz
- Thermal shock (all UTS versions except UTS RJ45):
5 cycles 30 min. from -40°C to 105°C per MIL-STD 1344 method 1003

Environmental

- 2 • Operating temperature:
from -40°C to +105°C
40/100/21 per NFF 61-030
- Flammability rating:
UL94-V0 (all UTS except the Hi seal) - see page 60
UL94-HB (UTS Hi seal only) - see page 60
I2F3/I3F2 per NFF 61-030
- 3 • Salt spray:
≥500 hours
- 4 • UV resistant:
No mechanical degradation or important variation of colour after 5 years of exposure in natural environment (equivalence exposure to sun and moisture as per ISO4892)
- 5 • Sealing:
 - UTS Standard: IP68/IP69K (mated)
 - UTS Hi seal: IP68/IP69K (mated and unmated)
 - UTS Discrete wire sealing: IP67/69K (up to IP68 with easy handling backshell)
 - UTS Screw termination contacts: IP68/IP69K
 - UTS RJ45: IP65Note: IPx8: 1m underwater during 1 week
- Fluid resistance:
 - Gasoil
 - Mineral oil
 - Acid bath
 - Basic bath





UTS Series

characteristics



Electrical

- See pages 14 to 20

Material

- Body connector + Backshell:
Thermoplastic
- Insert:
 - UTS Standard, UTS Discrete wire sealing, UTS Screw termination contacts & UTS RJ45:
Thermoplastic
 - UTS Hi seal handsolder & UTS Hi seal with PC tails contacts:
Elastomer
- Contacts:
See page 39
- Nut:
Metal
- Halogen free
- RoHS compliant & conform to the Chinese standard SJ/T1166-2006 (Chinese RoHS equivalent)
- In accordance with:
 - UL 1977:
Certificat ECBT2
File number: E169916
 - CSA C22.2 n°182.3:
Certificat ECBT8
File number: E169916





UTS Layout Guide

Contact quantity	Shell size	Wire dimension & Contacts size			
		AWG 22 to 12 0.13 to 4 mm ²	AWG 26 to 18 0.13 to 0.93 mm ²	AWG 30 to 14 0.05 to 2.5 mm ²	AWG 16 to 8 1.5 to 10 mm ²
		Contact #12 / Ø2.4mm	Contact #20 / Ø1mm	Contact #16 / Ø1.6mm	Contact #8 / Ø3.6mm
2	8		8E2 (Solder) 8D2 (PCB)		
	12			12E2 (Solder) 12D2 (PCB)	
2 + PE	10			103 (Crimp)	142G1 (Crimp)
3	8		8E3, 8E3A, 8E98, 8E33 (Solder) 8D3, 8D3A, 8D98, 8D33 (PCB)		
	12			12E3 (Solder) 12D3 (PCB)	
3 + PE	12			124 (Crimp) 124 (Screw) *	
4	8		8E4 (Solder) 8D4 (PCB)		
	10	102W2 (Crimp, 2#20 + 2#12)			
	10			104 (Crimp)	
5	14			145 (Crimp)	
6	10		106 (Crimp) 10E6, 10E98 (Solder) 10D6, 10D98 (PCB)		
			103W3 (Crimp, 3#20 + 3#16)		
6 + PE	14			147 (Crimp) 147 (Screw) *	
7	10		10E7 (Solder) 10D7 (PCB)		
8	12		12E8 (Solder) 12D8 (PCB)	128 (Crimp)	
10	12		1210 (Crimp) 12E10 (Solder) 12D10 (PCB)		
11	18			18E11 (Solder) 18D11 (PCB)	
12	14			1412 (Crimp)	
			14E12 (Solder, 8#20 + 4#16) 14D12 (PCB, 8#20 + 4#16)		
14	12		12E14 (Solder) 12D14 (PCB)		
15	14		1415 (Crimp, 14#20 + 1#16)		
19	14		1419 (Crimp) 14E19 (Solder) 14D19 (PCB)		
23	18			1823 (Crimp) 18E23 (Solder) 18D23 (PCB)	
30	18		18E30 (Solder, 29#20 + 1#16) 18D30 (PCB, 29#20 + 1#16)		
32	18			1832 (Crimp) 18E32 (Solder) 18D32 (PCB)	

* AWG 20 to 14, 0.5 to 2.5 mm². Contact #16.

Note: PE=protective earth



UTS Series

Contact layouts

Size 8

8E2 8D2 2 Ø1 (#20)	8E3 8D3 3 Ø1 (#20)	8E3A/8E98 8D3A/8D98 3 Ø1 (#20)	8E4 8D4 4 Ø1 (#20)	8E33 8D33 3 Ø1 (#20)
--	--	--	--	--

UTS layouts:

- - = UTS standard version (Ex: 1210)
- E - = UTS Hi seal + Solder (Ex: 12E10)
- D - = UTS Hi seal + PCB (Ex: 12D10)
- = UTS standard version
- = UTS Hi seal version
- ▲ = UTS discrete wire sealing version
- = UTS with screw contact termination
- = In-Line version

Size 10

102W2 2 Ø2.4 (#12) 2 Ø1.0 (#20)	103 (2+PE) 3 Ø1.6 (#16)	103W3 3 Ø1.6 (#16) 3 Ø1.0 (#20)	104 4 Ø1.6 (#16)	106 10E6 10D6 6 Ø1 (#20)	10E7 10D7 7 Ø1 (#20)	10E98 10D98 6 Ø1 (#20)
--	--	--	--------------------------------	--	--	--

Size 12

12E2 12D2 2 Ø1.6 (#16)	12E3 12D3 3 Ø1.6 (#16)	124 (3+PE) 4 Ø1.6 (#16)	128 8 Ø1.6 (#16)	12E8 12D8 8 Ø1 (#20)	1210 12E10 12D10 10 Ø1 (#20)	12E14 12D14 14 Ø1 (#20)
--	--	--	--------------------------------	--	--	---

Size 14

142G1 (2+PE) 3 Ø3.6 (#8)	14E5 14D5 5 Ø1.6 (#16)	147 (6+PE) 7 Ø1.6 (#16)	1412 12 Ø1.6 (#16)	14E12 14D12 8 Ø1 (#20) 4 Ø1.6 (#16)	1415 14 Ø1 (#20)	14E18 14D18 18 Ø1 (#20)	1419 14E19 14D19 19 Ø1 (#20)
---	--	--	----------------------------------	--	--------------------------------	---	--

Size 18

18E11 18D11 11 Ø1.6 (#16)	1823 18E23 18D23 23 Ø1.6 (#16)	18E30 18D30 29 Ø1 (#20) 1 Ø1.6 (#16)	1832 18E32 18D32 32 Ø1 (#20)	RJ45
---	--	---	--	-----------------



De-rating curves

Size 8

8E2 8D2



Contacts :
2 Ø 1 (#20)

UL
7A 250V UL94 HB

CSA
7A 250V UL94 HB

IEC
7A 63V 2.5kV 3

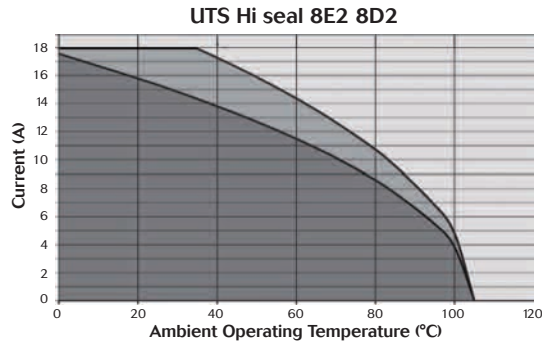

8E3 8D3



Contacts :
3 Ø 1 (#20)

UL
7A 250V UL94 HB

CSA
7A 250V UL94 HB

IEC
7A 40V 2.5kV 3

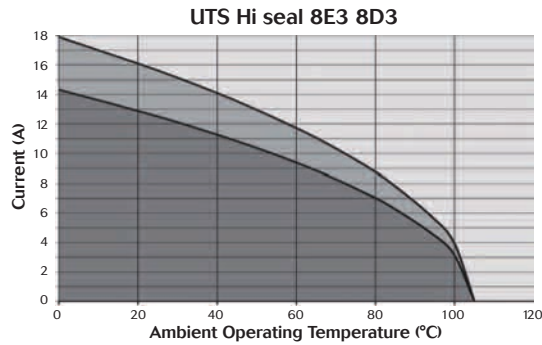

8E3A/8E98 8D3A/8D98

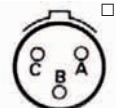

Contacts :
3 Ø 1 (#20)

UL
7A 250V UL94 HB

CSA
7A 250V UL94 HB

IEC
7A 40V 2.5kV 3

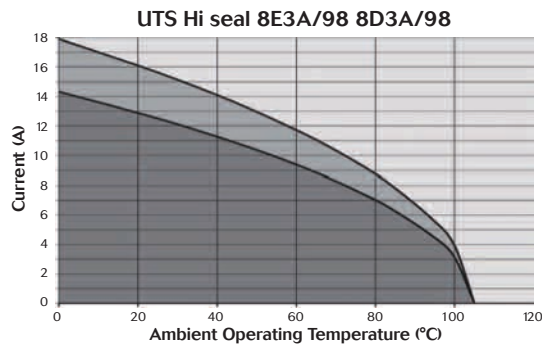

8E4 8D4



Contacts :
4 Ø 1 (#20)

UL
7A 250V UL94 HB

CSA
7A 250V UL94 HB

IEC
7A 40V 2.5kV 3

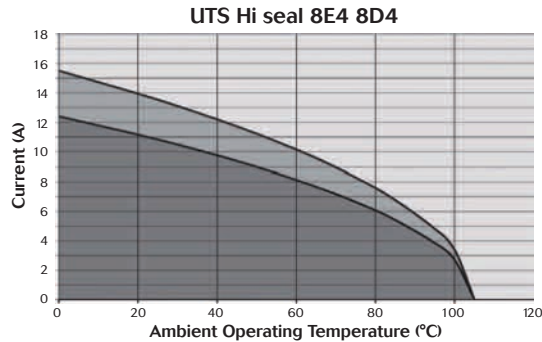

Test conditions

Contact used:

Machined contacts

Wires used:

0.518mm² for #20 contacts
1.31mm² for #16 contacts
3.31mm² for #12 contacts
8.37mm² for #8 contacts

Layouts

- UTS standard version
- ▲ UTS discrete wire sealing version
- In-Line version
- UTS Hi seal version
- UTS with screw contact termination

Derating curve

- Current use
- Limited use
- Not recommended use



UTS Series

Size 8

8E33
8D33

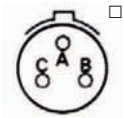

Contacts :
3 Ø 1 (#20)

UL
7A 250V UL94 HB

CSA
7A 250V UL94 HB

IEC
7A 100V 2.5kV 3

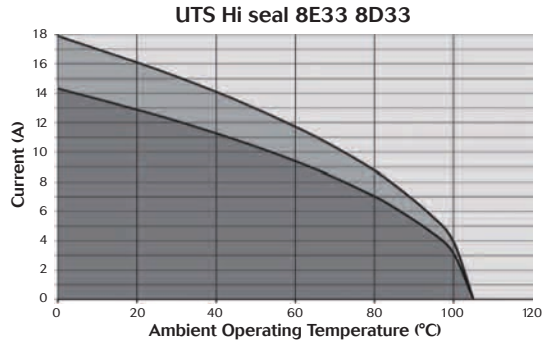

Size 10

102W2



Contacts :
2 Ø2.4 (#12)
2 Ø1.0 (#20)

UL
20A 500V UL94 V-0

CSA
18A 500V UL94 V-0

IEC
25A 200V 3kV 3
Temperature elevation: 50°C

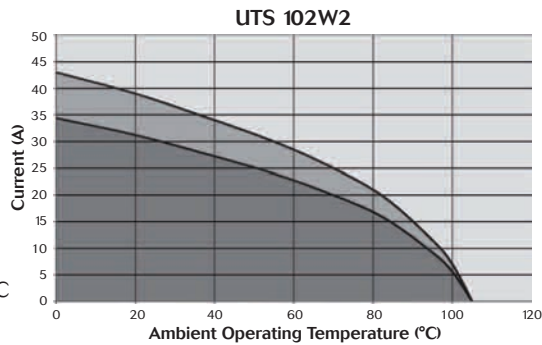

103
(2+PE)



Contacts* :
3 Ø 1.6 (#16)

UL
10A 500V UL94 V-0

CSA
7A 500V UL94 V-0

IEC
16A 320V 4kV 3
Temperature elevation: 50°C

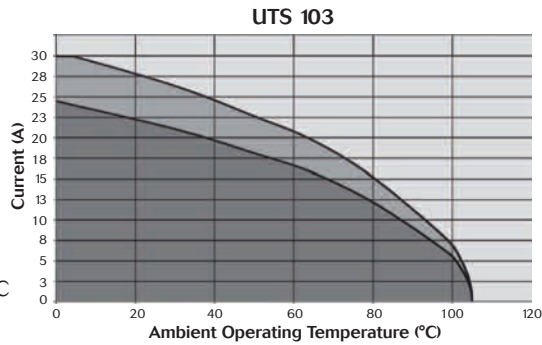

104



Contacts :
4 Ø 1.6 (#16)

UL
10A 500V UL94 V-0

CSA
7A 500V UL94 V-0

IEC
16A 200V 3kV 3

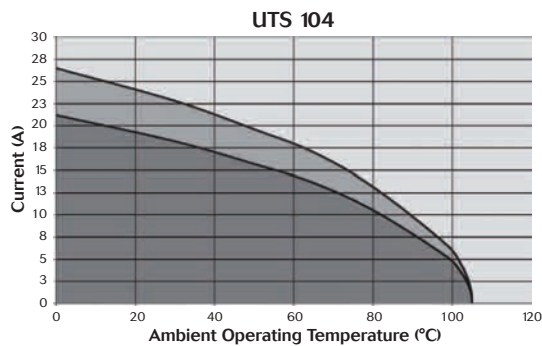

Test conditions

- Contact used:**
Machined contacts
- Wires used:**
0.518mm² for #20 contacts
1.31mm² for #16 contacts
3.31mm² for #12 contacts
8.37mm² for #8 contacts

Layouts

- UTS standard version
- ▲ UTS discrete wire sealing version
- In-Line version
- UTS Hi seal version
- UTS with screw contact termination

Derating curve

- Current use
- Limited use
- Not recommended use

UTS Series



Size 10

106

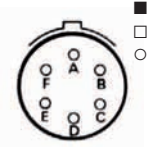

Contacts :
6 Ø 1 (#20)

UL
5A 250V UL94 V-0

CSA
4A 250V UL94 V-0

IEC
6A 40V 1.5kV 3

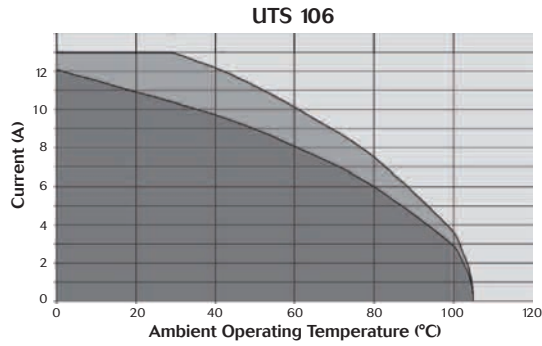

10E6 10D6

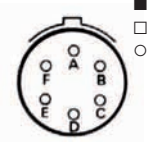

Contacts :
6 Ø 1 (#20)

UL
6A 250V UL94 HB

CSA
6A 250V UL94 HB

IEC
10A 100V 2.5kV 3

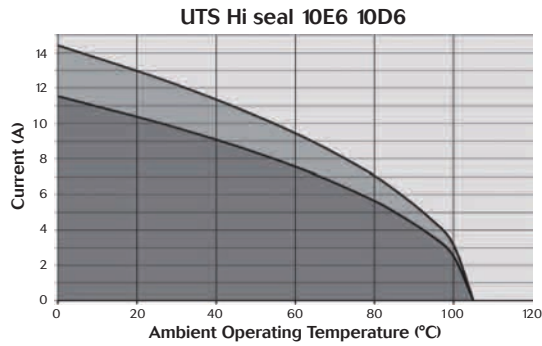

10E7 10D7

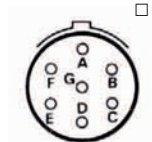

Contacts :
7 Ø 1 (#20)

UL
6A 250V UL94 HB

CSA
6A 250V UL94 HB

IEC
7A 100V 2.5kV 3

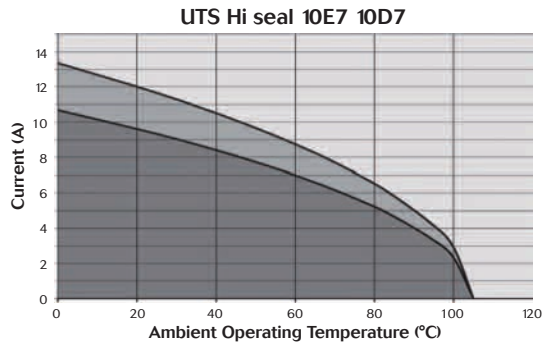

Test conditions

Contact used:
Machined contacts

Wires used:
0.518mm² for #20 contacts
1.31mm² for #16 contacts
3.31mm² for #12 contacts
8.37mm² for #8 contacts

Size 12

12E2 12D2

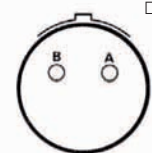

Contacts :
2 Ø 1.6 (#16)

UL
13A 650V UL94 HB

CSA
13A 650V UL94 HB

IEC
16A 160V 3kV 3

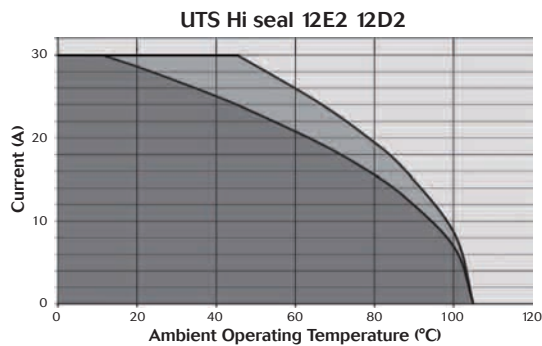

Layouts

- UTS standard version
- ▲ UTS discrete wire sealing version
- In-Line version
- UTS Hi seal version
- UTS with screw contact termination

Derating curve

- Current use
- ▒ Limited use
- Not recommended use



UTS Series

Size 12

12E3 12D3

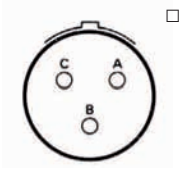

Contacts :
3 Ø 1.6 (#16)

UL
13A 650V UL94 HB
CSA
13A 650V UL94 HB
IEC
16A 160V 3kV 3

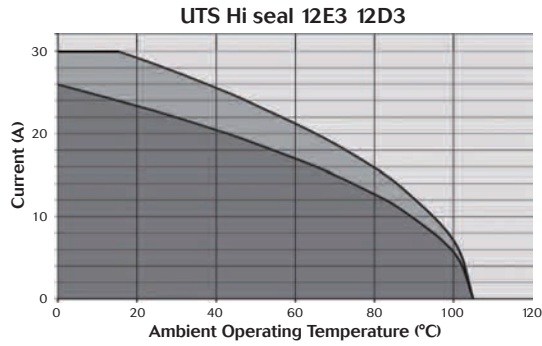

124 (3+PE)

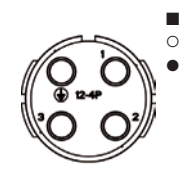

Contacts* :
4 Ø 1.6 (#16)

UL
10A 500V UL94 V-0
CSA
7A 500V UL94 V-0
IEC
16A 400V 4kV 3
Temperature elevation: 50°C

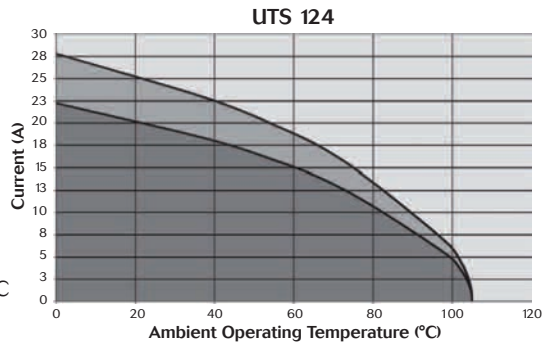

128



Contacts :
8 Ø 1.6 (#16)

UL
10A 500V UL94 V-0
CSA
7A 500V UL94 V-0
IEC
10A 80V 2.5kV 3

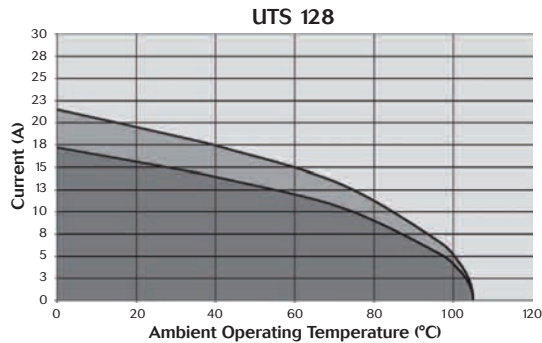

12E8 12D8

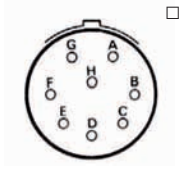

Contacts :
8 Ø 1 (#20)

UL
4.5A 250V UL94 HB
CSA
4.5A 250V UL94 HB
IEC
7A 100V 2.5kV 3

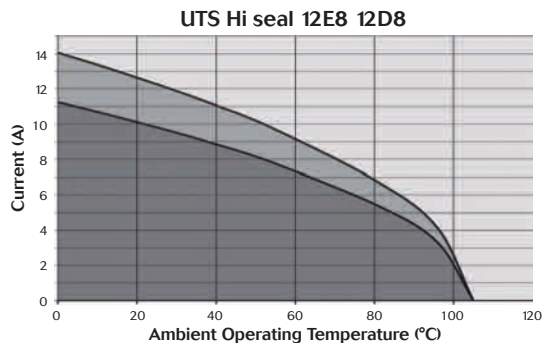

Test conditions

Contact used:
Machined contacts
Wires used:
0.518mm² for #20 contacts
1.31mm² for #16 contacts
3.31mm² for #12 contacts
8.37mm² for #8 contacts

Layouts

- UTS standard version
- ▲ UTS discrete wire sealing version
- In-Line version
- UTS Hi seal version
- UTS with screw contact termination

Derating curve

- Current use
- ▒ Limited use
- Not recommended use

UTS Series



Size 12

12 10

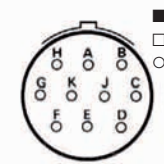

Contacts :
10 Ø 1 (#20)

UL
5A 250V UL94 V-0
CSA
4A 250V UL94 V-0
IEC
6A 40V 1.5kV 3

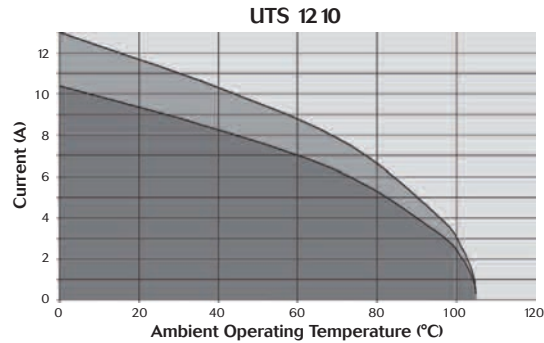

12E10 12D10

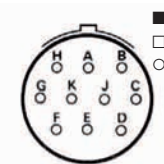

Contacts :
10 Ø 1 (#20)

UL
4.5A 250V UL94 HB
CSA
4.5A 250V UL94 HB
IEC
7A 100V 2.5kV 3

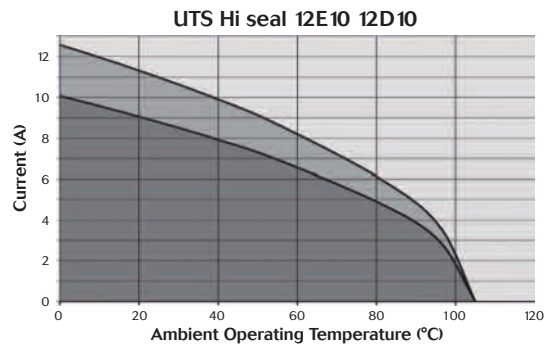

12E14 12D14

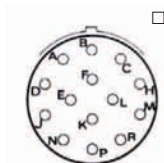

Contacts :
14 Ø 1 (#20)

UL
4.5A 250V UL94 HB
CSA
4.5A 250V UL94 HB
IEC
7A 32V 2.5kV 3

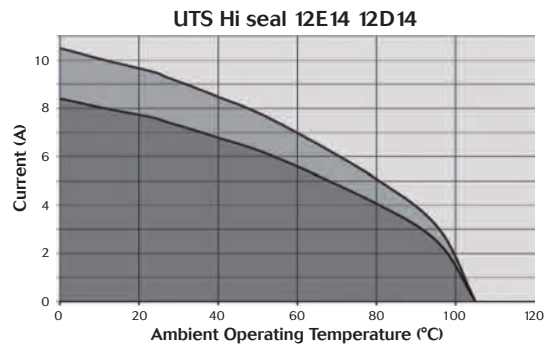

Test conditions

Contact used:
Machined contacts
Wires used:
0.518mm² for #20 contacts
1.31mm² for #16 contacts
3.31mm² for #12 contacts
8.37mm² for #8 contacts

Size 14

142G1

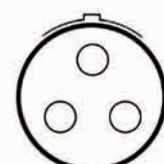

Contacts :
3 Ø 3.6 (#8)

UL
44A 600V UL94 V-0
CSA
30A 600V UL94 V-0
IEC
42A 230V 4kV 3

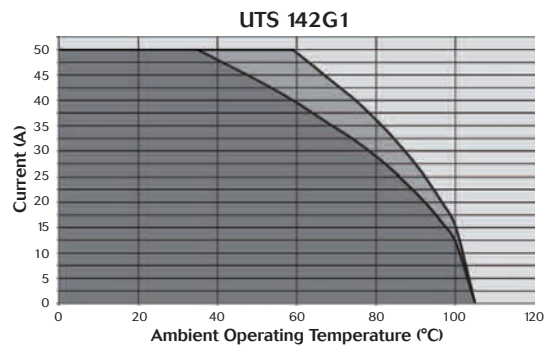

Layouts

- UTS standard version
- ▲ UTS discrete wire sealing version
- In-Line version
- UTS Hi seal version
- UTS with screw contact termination

Derating curve

- Current use
- Limited use
- Not recommended use



UTS Series

Size 14

14E5 14D5

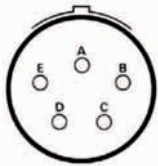

Contacts :
5 Ø 1.6 (#16)

UL
12A 650V UL94 HB
CSA
12A 650V UL94 HB
IEC
16A 160V 3kV 3

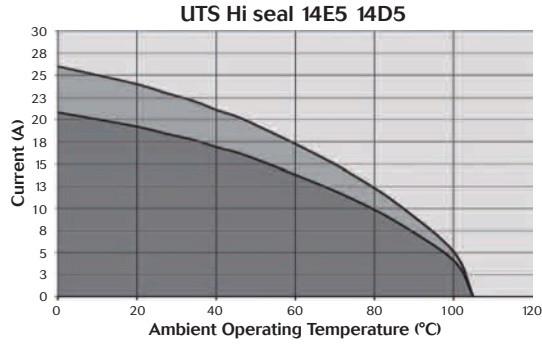

147 (6+PE)

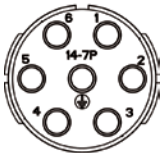

Contacts* :
7 Ø 1.6 (#16)

UL
10A 500V UL94 V-0
CSA
7A 500V UL94 V-0
IEC
16A 400V 4kV 3
Temperature elevation: 50°C

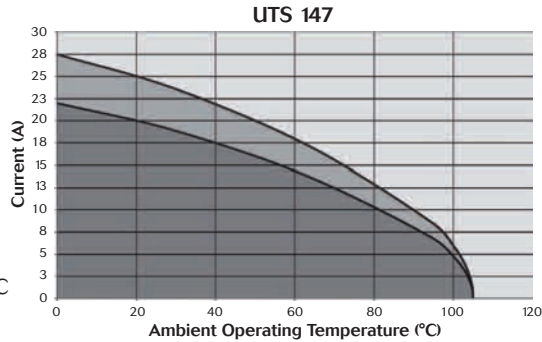

1412

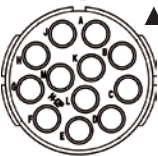

Contacts :
12 Ø 1.6 (#16)

UL
10A 500V UL94 V-0
CSA
7A 500V UL94 V-0
IEC
10A 80V 2.5kV 3

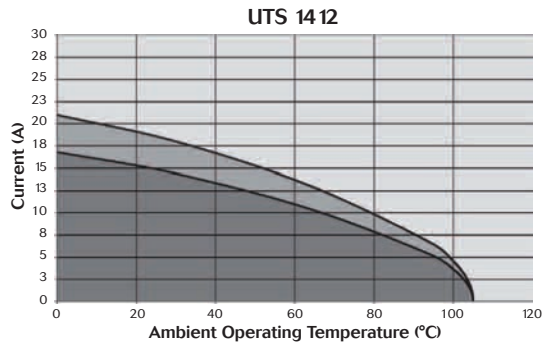

14E18 14D18

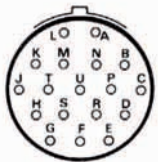

Contacts :
18 Ø 1 (#20)

UL
4A 250V UL94 HB
CSA
4A 250V UL94 HB
IEC
7A 100V 2.5kV 3

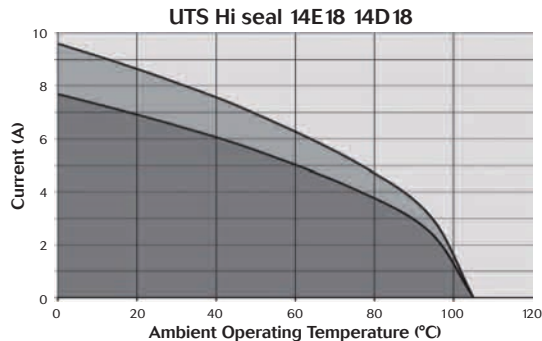

Test conditions

Contact used:
Machined contacts
Wires used:
0.518mm² for #20 contacts
1.31mm² for #16 contacts
3.31mm² for #12 contacts
8.37mm² for #8 contacts

Layouts

- UTS standard version
- ▲ UTS discrete wire sealing version
- In-Line version
- UTS Hi seal version
- UTS with screw contact termination

Derating curve

- Current use
- Limited use
- Not recommended use

UTS Series



Size 14

1419

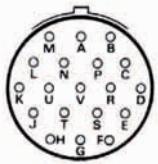

Contacts :
19 Ø 1 (#20)

UL
5A 250V UL94 V-0
CSA
4A 250V UL94 V-0
IEC
4A 40V 1.5kV 3

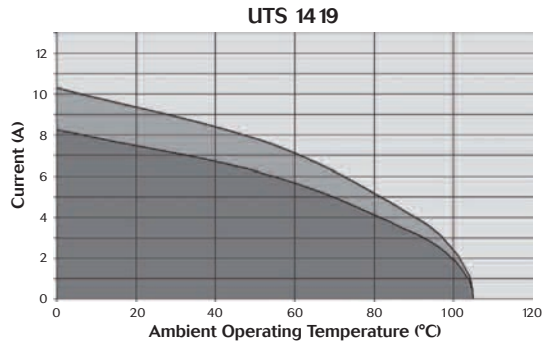

14E19

14D19

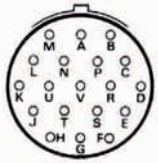

Contacts :
19 Ø 1 (#20)

UL
4A 250V UL94 HB
CSA
4A 250V UL94 HB
IEC
7A 100V 2.5kV 3

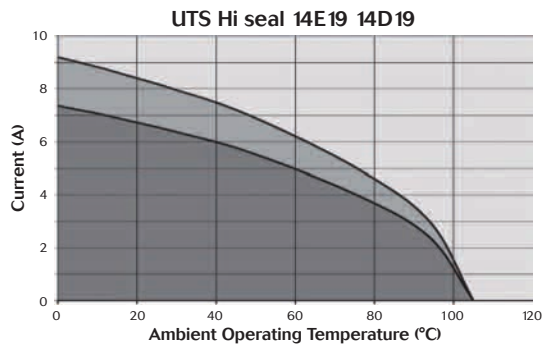

Size 18

1823

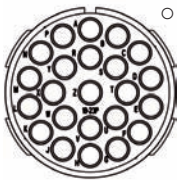

Contacts :
23 Ø 1.6 (#16)

UL
10A 500V UL94 V-0
CSA
7A 500V UL94 V-0
IEC
10A 80V 2.5kV 3

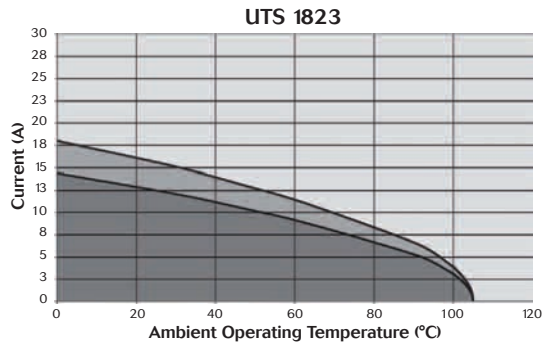

1832

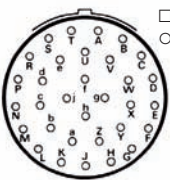

Contacts :
32 Ø 1 (#20)

UL
5A 250V UL94 V-0
CSA
4A 250V UL94 V-0
IEC
3A 32V 1.5kV 3

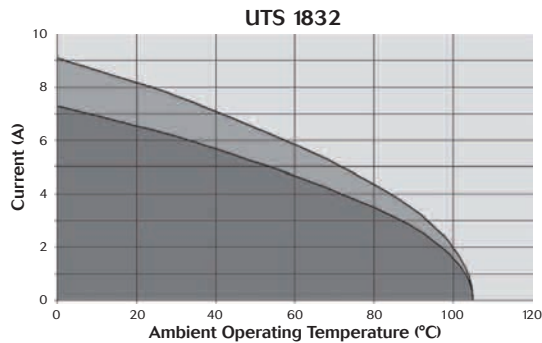

Test conditions

Contact used:
Machined contacts
Wires used:
0.518mm² for #20 contacts
1.31mm² for #16 contacts
3.31mm² for #12 contacts
8.37mm² for #8 contacts

Layouts

- UTS standard version
- ▲ UTS discrete wire sealing version
- In-Line version
- UTS Hi seal version
- UTS with screw contact termination

Derating curve

- Current use
- ▒ Limited use
- Not recommended use

UNIT'S Series



UTS Series

Mechanics

■ UTS plug cable gland backshell	24
■ UTS square flange receptacle	26
■ UTS jam nut receptacle with accessories	28
■ PCB version: nominal length out	30
■ UTS in line receptacle with accessories	32
■ Accessories.....	34
■ Cable assembly.....	36

UTS Series



Mechanics

UTS plug cable gland backshell

Part number



Contact type	Connector type	Termination	Contact sex	Shell size	Part number	
Crimp contacts supply separately	UTS standard	Cable gland	Male	10	UTS6JC - - P	
				12		
				14		
			18			
			Female	10		UTS6JC - - S
				12		
		14				
		Nut and grommet	Female	18	UTS6GN104S	
				10	UTS6GN128S	
				12	UTS6GN147S	
			Cable gland and grommet	Female	14	UTS6GN1412S
					10	UTS6GJC104S
					12	UTS6GJC128S
		14	UTS6GJC147S			
14	UTS6GJC1412S					
Solder contacts loaded	Hi seal	No backshell	Male	8	UTS6 - E - P	Sealed Unmated
				10		
				12		
			Female	14	UTS6 - E - S	Sealed Unmated
				18		
				8		
				10		
				12		
				14		
		Cable gland	Male	18	UTS6JC - E - P	Sealed Unmated
				8		
				10		
			Female	12	UTS6JC - E - S	Sealed Unmated
				14		
				18		
				8		
				10		
				12		
14	On demand					
Screw contacts loaded	UTS standard	Cable gland	Male	12	UTS6JC124PSCR	
				14	UTS6JC147PSCR	
			Female	12	UTS6JC124SSCR	
				14	UTS6JC147SSCR	
RJ45	UTS standard	Cable gland	-	18	UTS6JC18RJN	

For coding " - - " see p.6 and UTS layout guide p.12.

UTS Series



Dimensions

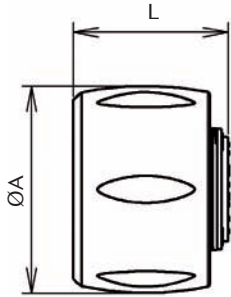

Fig. 1

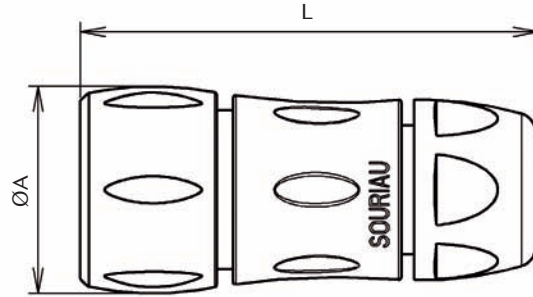

Fig. 2

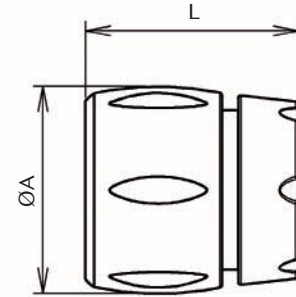

Fig. 3

Part number	Shell size	L (total length)	ØA	Figure	
UTS6JC - - P	10	63.2	26.7	Fig. 2	
	12	66.7	30.2		
	14	71.5	35.1		
	18	81.3	42		
UTS6JC - - S	10	63.2	26.7		
	12	66.7	30.2		
	14	71.5	35.1		
	18	81.3	42		
UTS6GN 104S	10	32	26.2	Fig. 3	
UTS6GN 128S	12	32.3	29.7		
UTS6GN 147S	14	32	34.6		
UTS6GN 1412S					
UTS6GJC 104S	10	61.5	26.2	Fig. 2	
UTS6GJC 128S	12	64.5	29.7		
UTS6GJC 147S	14	70	34.6		
UTS6GJC 1412S					
UTS6 - E - P	8	21.3	22.5	Fig. 1	
	10	23.6	26.7		
	12	23.6	30.2		
	14	23.6	35.1		
UTS6 - E - S	8	21.3	22.5		Sealed Unmated
	10	23.6	26.7		
	12	23.6	30.2		
	14	23.6	35.1		
UTS6JC - E - P	8	54	22.5	Fig. 2	
	10	63.2	26.7		
	12	66.7	30.2		
	14	71.5	35.1		
UTS6JC - E - S	8	54	22.5		Sealed Unmated
	10	63.2	26.7		
	12	66.7	30.2		
	14	71.5	35.1		
UTS6JC 124PSCR	12	66.7	29.7	Fig. 2	
		71.5	34.6		
		66.7	29.7		
		71.5	34.6		
UTS6JC 147PSCR	14	71.5	34.6		
UTS6JC 124SSCR	12	66.7	29.7		
UTS6JC 147SSCR	14	71.5	34.6		
UTS6JC 18RJN	18	81.3	42		Fig. 2

For coding " - - " see p.6 and UTS layout guide p. 12.

Note : all dimensions are in mm



Mechanics UTS square flange receptacle

Part number



Contact type	Connector type	Contact sex	Shell size	Part number
Crimp contacts supply separately	UTS standard	Male	10	UTS0104P
			12	UTS0128P
			14	UTS01412P
			18	UTS01823P
		Female	10	UTS0104S
			12	UTS0128S
			14	UTS01412S
			18	UTS01823S
Solder contacts loaded	Hi seal	Male	8	UTS0 - E - P
			10	
			12	
			14	
		Female	18	On demand
			8	UTS0 - E - S
			10	
			12	
14				
18	On demand			
PCB contacts loaded	Hi seal	Male	8	UTS0 - D - P
			10	
			12	
			14	
		Female	18	On demand
			8	UTS0 - D - S
			10	
			12	
14				
18	On demand			
PCB contacts supply separately	UTS standard	Male	10	UTS0104P
			12	UTS0128P
			14	UTS01412P
			18	UTS01823P
		Female	10	UTS0104S
			12	UTS0128S
			14	UTS01412S
			18	UTS01823S

Sealed
Unmated

Sealed
Unmated

For coding " - " see p.6 and UTS layout guide p.12.



UTS Series

Dimensions

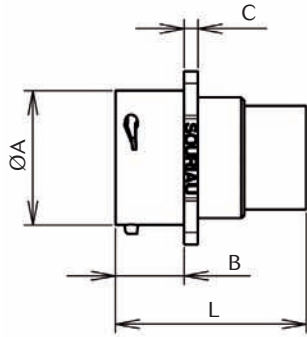

Fig. 1

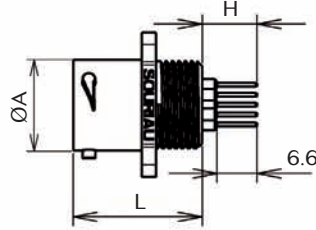

Fig. 2

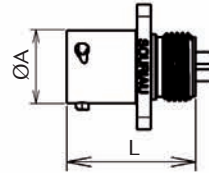
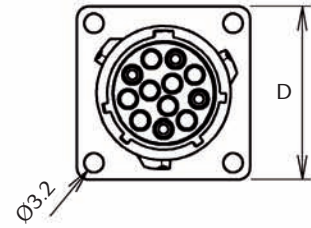

Fig. 3



Front view

Part number	Shell size	L (total length)	ØA	B	C	D	Figure				
UTS0104P	10	31.7	15	11.35	2.3	23.8	Fig. 1				
UTS0128P	12		19			26.2					
UTS01412P	14		22.2			28.6					
UTS01823P	18		28.5			33.3					
UTS0104S	10	24.2	15		11.35	2.3		23.8	Fig. 1		
UTS0128S	12		19					26.2			
UTS01412S	14		22.2					28.6			
UTS01823S	18		28.5					33.3			
UTS0 - E - P	8	21.5	12	11.35		2.3	21	Fig. 3			
	10		23.8								
	12		26.2								
	14		28.6								
UTS0 - E - S	8		21.5		12		11.35		2.3	21	Fig. 3
	10				23.8						
	12				26.2						
	14				28.6						
UTS0 - D - P	8	21.5		11.9	11.3	2.3		21		Fig. 2	
	10			14.9				23.8			
	12			19				26.2			
	14			22.2				28.6			
UTS0 - D - S	8		21.5	12		11.3	2.3	21	Fig. 2		
	10			15				23.8			
	12			19				26.2			
	14			22.2				28.6			
UTS0104P	10	31.7		15	11.35		2.3	23.8		Fig. 2	
UTS0128P	12			19				26.2			
UTS01412P	14			22.2				28.6			
UTS01823P	18			28.5				33.3			
UTS0104S	10	24.2	15	11.35		2.3	23.8	Fig. 2			
UTS0128S	12		19				26.2				
UTS01412S	14		22.2				28.6				
UTS01823S	18		28.5				33.3				

**Sealed
Unmated**

H (for PCB contact): PCB nominal length (see page 30)
For coding " - " see p.6 and UTS layout guide p.12.

Note : all dimensions are in mm

UTS Series



Mechanics

UTS jam nut receptacle with accessories



Part number

Contact type	Connector type	Termination	Contact sex	Shell size	Part number		
Crimp contacts supply separately	UTS standard		Male	10	UTS7 - - P		
				12			
				14			
			Female	18	UTS7 - - S		
				10			
				12			
	Discrete wire sealing	Nut and grommet	Male	14	UTS7GN104P		
				12	UTS7GN128P		
				10	UTS7GN147P		
		Cable gland and grommet	Male	14	UTS7GN1412P		
				10	UTS7GJC104P		
				12	UTS7GJC128P		
14	UTS7GJC147P						
14	UTS7GJC1412P						
Solder contacts loaded	Hi seal with stand off	Standard receptacle	Male	8	UTS7 - E - P		
				10			
				12			
			Female	14	UTS7 - E - S		
				18			
				8			
		10	On demand				
		12	UTS7128PSEK9				
		14	UTS7147PSEK9				
		PCB contacts loaded	UTS standard with stand off	Receptacle with hold down clip	Male	8	UTS7 - D - P
						10	
						12	
Female	14				UTS7 - D - S		
	18						
	8						
Hi seal with stand off	Receptacle without hold down clip		Male	10	UTS7 - D - P32		
				12			
				14			
	Receptacle with hold down clips		Female	18	UTS7 - D - S32		
				8			
				10			
12	On demand						
14	On demand						
PCB contacts supply separately	UTS standard		Male	10	UTS7 - - P		
				12			
				14			
			Female	18	UTS7 - - S		
				10			
				12			
Screw contacts loaded	UTS standard		Male	14	UTS7124PSCR		
				12	UTS7147PSCR		
			Female	14	UTS7124SSCR		
				12	UTS7147SSCR		
RJ45	UTS standard		-	18	UTS718RJFN		

Sealed
Unmated

Sealed
Unmated

Sealed
Unmated

Sealed
Unmated

Sealed
Unmated

Sealed
Unmated

For coding " - - " see p.6 and UTS layout guide p.12.

UTS Series



Dimensions

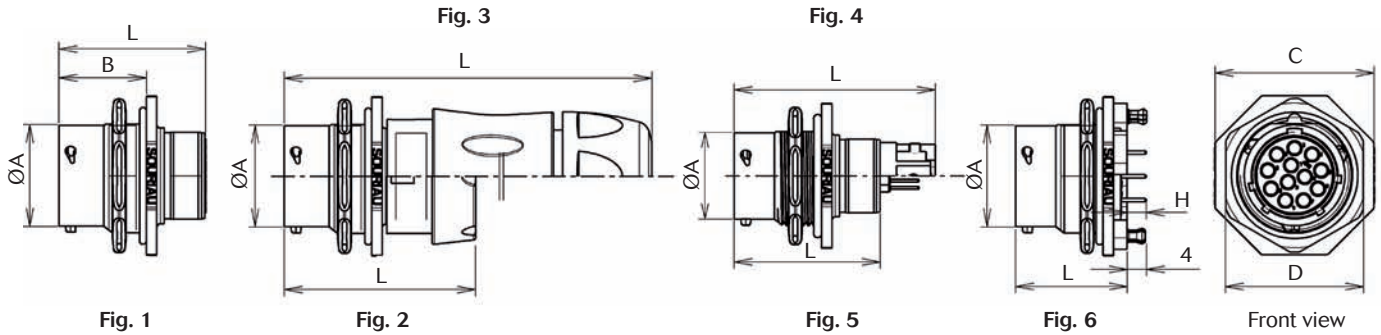

Part number	Shell size	L (total length)	ØA	B	C	D	Figure
UTS7 - - P	10	33.9	14.9	19.3	27	22.2	Fig. 1
	12		19		31.8	27	
	14		22.2		34.9	30.2	
	18		28.5		41.3	36.6	
	10		14.9		27	22.2	
UTS7 - - S	12	33.9	19	19.3	31.8	27	Fig. 1
	14		22.2		34.9	30.2	
	18		28.5		41.3	36.6	
	10		14.9		27	22.2	
UTS7GN104P	10	41	14.9	19.3	27	22.2	Fig. 2
UTS7GN128P	12	40.7	19		31.8	27	
UTS7GN147P	14	43	22.2	19.3	34.9	30.2	Fig. 2
UTS7GN1412P							
UTS7GJC104P	10	70.5	14.9	19.3	27	22.2	Fig. 3
UTS7GJC128P	10	74	19		31.8	27	
UTS7GJC147P	14	80.5	22.2		19.3	34.9	
UTS7GJC1412P							
UTS7 - E - P	8	25	12	19.3	24	19.3	Fig. 5
	10		14.9		27	22.2	
	12		19		31.8	27	
	14		22.2		34.9	30.2	
UTS7 - E - S	8	25	12	19.3	24	19.3	Sealed Unmated
	10		14.9		27	22.2	
	12		19		31.8	27	
	14		22.2		34.9	30.2	
UTS7128PSEK9	12	25	19	19.3	31.8	27	Fig. 6
UTS7147PSEK9	14		22.1		34.9	30.2	
UTS7 - D - P	8	25	12	19.3	24	19.3	Fig. 6
	10		14.9		28	22.2	
	12		19		31.8	27	
	14		22.2		34.9	30.2	
UTS7 - D - S	8	25	12	19.3	24	19.3	Fig. 6
	10		14.9		28	22.2	
	12		19		31.8	27	
	14		22.2		34.9	30.2	
UTS7 - D - P32	8	25	12	19.3	24	19.3	Sealed Unmated
	10		14.9		28	22.2	
	12		19		31.8	27	
	14		22.2		34.9	30.2	
UTS7 - D - S32	8	25	12	19.3	24	19.3	Fig. 6
	10		14.9		28	22.2	
	12		19		31.8	27	
	14		22.2		34.9	30.2	
UTS7 - - P	10	33.9	14.9	19.3	27	22.2	Fig. 5
	12		19		31.8	27	
	14		22.2		34.9	30.2	
	18		28.5		41.3	36.6	
	10		14.9		27	22.2	
UTS7 - - S	12	33.9	19	19.3	31.8	27	Fig. 5
	14		22.2		34.9	30.2	
	18		28.5		41.3	36.6	
	10		14.9		27	22.2	
UTS7124PSCR	12	46.5	19	19.3	31.8	27	Fig. 4
UTS7147PSCR	14	52.5	22.2		34.9	30.2	
UTS7124SSCR	12	38.3	19	19.3	31.8	27	Fig. 4
UTS7147SSCR	14	44.4	22.2		34.9	30.2	
UTS718RJFN	18	48	28.5	19.3	41.3	36.6	

H (for PCB contact): PCB nominal length (see page 30)
For coding " - - " see p.6 and UTS layout guide p.12.

Note : all dimensions are in mm

UTS Series



Mechanics Solder tail protrusion

Dimensions

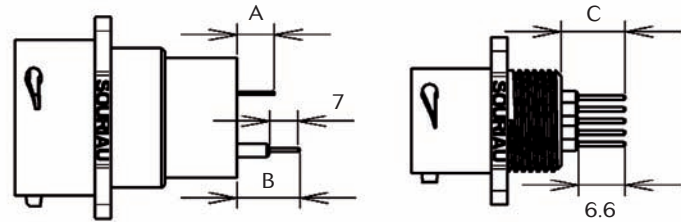

Contact type	Connector type	Contact size	Contact sex	Part number	Shell size	Layout	A	C	
PCB contacts supply separately	UTSO Standard	16	Male	RM20M12E8□	10 to 18	-	50.2	-	
				RM20M12E83□		-	10.3	-	
			Female	RC20M12E8□		-	5.2	-	
				RC20M12E83□		-	10.4	-	
				RC20M12E84□		-	13.9	-	
PCB contacts loaded	UTSO Hi seal	16 & 20	Male	-	8	8E2 8E3 8E4	-	9.76 to 11.86	
				-		8E3A 8E98	-	10.78 to 13.09	
				-	10	-	-	8.1 to 10.5	
				-		12	-	-	8.1 to 10.5
				-			12 14	-	7.2 to 9.3
				-		14	-	-	8.1 to 10.5
			Female	8	8E2 8E3 8E4	-	9.55 to 11.71		
					8E3A 8E98	-	10.82 to 12.79		
				10	-	-	8.15 to 10.15		
					12	-	-	8.15 to 10.15	
						12 14	-	7.3 to 9.3	
					14	-	-	8.15 to 10.15	

□ = plating - see available plating p.44

Note : all dimensions are in mm

UTS Series



Dimensions

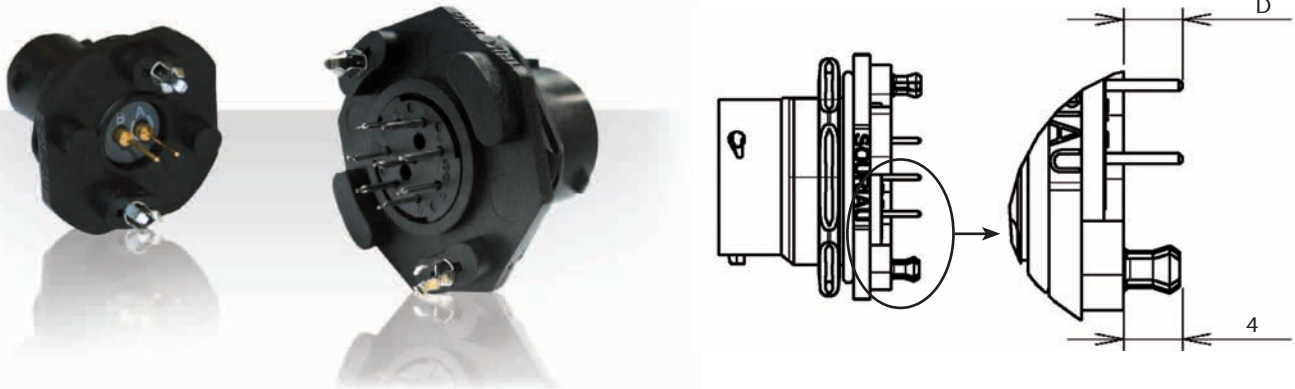

Contact type	Connector type	Contact size	Contact sex	Part number	Shell size	Layout	A	B	C	D		
PCB contacts supply separately	UTS7 Standard	16	Male	RM20M12E8□	10 to 18	-	4.1	-	-	-		
				RM20M12E83□	10 to 18	-	9.2	-	-	-		
					20 & 22	-	4.85	-	-	-		
					24	-	3.35	-	-	-		
			Female	RC20M12E84□	10 to 18	-	4.65	-	-	-		
					10 & 12	-	7.15	-	-	-		
					14	-	7.85	-	-	-		
					16 & 18	-	7.15	-	-	-		
		RC20M12E85□		20	-	3.4	-	-	-			
				22	-	2.7	-	-	-			
				24	-	1.3	-	-	-			
				RC20M12E86□	10 & 12	-	7.95	-	-	-		
		14	-		8.65	-	-	-				
		16 & 18	-		7.95	-	-	-				
		20	-		4.2	-	-	-				
		20		Male	RMW50A7K	10 to 16	-	9.51	-	-	-	
18 to 22	-					5	-	-	-			
24	-					3.6	-	-	-			
RMW5016K	10 to 16				-	-	10.41	-	-			
	18 to 22			-	-	6	-	-				
Female	RCW50A7K RCW5016K			10 to 16	-	2.4	-	-				
				-	-	3.04	-	-				
PCB contacts loaded	UTS7 with stand off version			16	Male & Female	-	12 & 14	-	-	-	3.6	-
	UTS7 Hi seal without stand off	20	Male	-	8	8D2 8D3 8D4	-	-	-	-	3.8 to 6	
				-	10	8D3A 8D98 8D33	-	-	-	-	4.7 to 7.25	
				-	12	10D6 10D7	-	-	-	-	4.9 to 7	
				-	12	12D2 12D3 12D8 12D10	-	-	-	-	4.8 to 7	
				-	12	12D14	-	-	-	-	3.85 to 5.9	
				-	14	14D5 14D12 14D15 14D18 14D19	-	-	-	-	4.8 to 7	
			Female	-	8	8D2 8D3 8D4	-	-	-	-	-	3.75 to 5.8
				-	10	8D3A 8D98 8D33	-	-	-	-	-	4.8 to 6.9
				-	12	10D6 10D7	-	-	-	-	-	4.9 to 7
				-	12	12D2 12D3 12D8 12D10	-	-	-	-	-	5.2 to 7
				-	12	12D14	-	-	-	-	-	3.85 to 5.9
				-	14	14D5 14D12 14D15 14D18 14D19	-	-	-	-	-	5.3 to 7

□ = plating - see available plating p.44

Note : all dimensions are in mm



Mechanics

UTS in line receptacle with accessories

Part number



Contact type	Connector type	Termination	Contact sex	Shell size	Part number
Crimp contacts supply separately	UTS standard	Cable gland	Male	10	UTS1JC - - P
				12	
				14	
				18	
			Female	10	UTS1JC - - S
				12	
				14	
				18	
	Discrete wire sealing	Nut and grommet	Male	10	UTS1GN104P
				12	UTS1GN128P
				14	UTS1GN147P
					UTS1GN1412P
Cable gland and grommet		Male	10	UTS1GJC104P	
			12	UTS1GJC128P	
			14	UTS1GJC147P	
				UTS1GJC412P	
Screw contacts loaded	UTS standard	Cable gland backshell	Male	12	UTS1JC124PSCR
				14	UTS1JC147PSCR

For coding " - - " see p.6 and UTS layout guide p. 12.



UTS Series

Dimensions

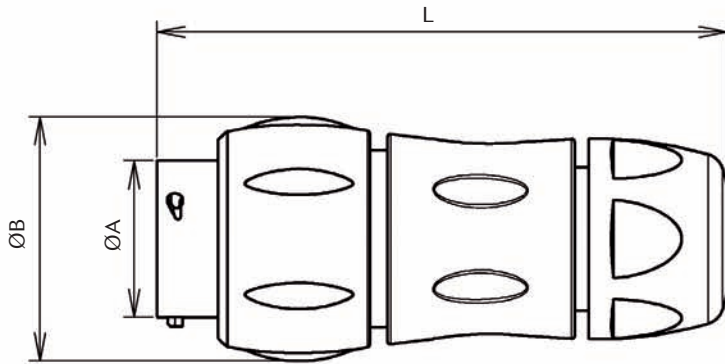

Fig. 1

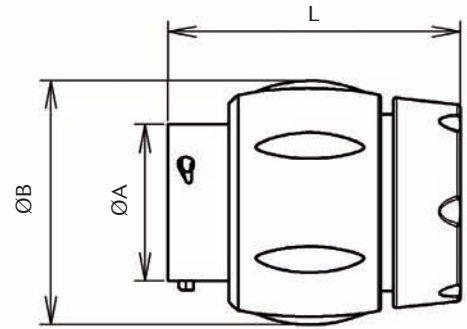

Fig. 2

Part number	Shell size	L (total length)	ØA	B	Figure
UTS1JC -- P	10	70	14.9	26.7	Fig. 1
	12	74	19	30.1	
	14	78.5	22.2	35.1	
	18	89	28.5	42	
UTS1JC -- S	10	70	14.9	26.7	
	12	74	19	30.1	
	14	78.5	22.2	35.1	
	18	89	28.5	42	
UTS1GN104P	10	40.9	14.9	26.2	Fig. 2
UTS1GN128P	12	40.9	19	29.7	
UTS1GN147P	14	43	22.2	34.6	
UTS1GN1412P					
UTS1GJC104P	10	70.7	14.9	26.2	Fig. 1
UTS1GJC128P	12	74.5	19	29.7	
UTS1GJC147P	14	80.5	22.2	34.6	
UTS1GJC412P					
UTS1JC124PSCR	12	74	19	29.7	Fig. 1
UTS1JC147PSCR	14	78.5	22.2	34.6	

For coding "--" see p.6 and UTS layout guide p.12.

Note : all dimensions are in mm

UTS Series



Accessories



Description

UTS series offers a wide range of accessories: from the plastic protective cap to the dust caps, coloured rings for visual identification or discrimination pins.

Colour coding rings



Part numbers		Shell size
Receptacles	Plugs	
UTS710CCR*	UTS610CCR*	10
UTS712CCR*	UTS612CCR*	12
UTS714CCR*	UTS614CCR*	14

* Add G for Green, Y for Yellow, R for Red

For shell sizes 8 & 18, please consult factory

Gasket



Part numbers / neoprene	Shell size
UTFD11B	8
UTFD12B	10
UTFD13B	12
UTFD14B	14
UTFD16B	18

PMA adapter



IP40 version

To get a PMA adapter you should change JC to PMA.
Ex: UTS6JC -- S → UTS6PMA -- S

Bending protection spiral



IP68/69K version

To get a spiral protection you should change JC to JS.
Ex: UTS6JC -- S → UTS6JS -- S



UTS Series

Jam nut sealing caps



Part numbers	Shell size
UTS8DCG	8
UTS10DCG	10
UTS12DCG	12
UTS14DCG	14
UTS18DCG	18



Metal terminal

Part numbers	Shell size
UTS8DCGR	8
UTS10DCGR	10
UTS12DCGR	12
UTS14DCGR	14
UTS18DCGR	18

Square flange sealing cap



Metal terminal

Part numbers	Shell size
UTS8DCGE	8
UTS10DCGE	10
UTS12DCGE	12
UTS14DCGE	14
UTS18DCGE	18

Plug sealing cap*



* Except for UTS RJ45 plug / ** Non sealed

Part numbers	Shell size
UTS68C **	8
UTS610DCG	10
UTS612DCG	12
UTS614DCG	14
UTS618DCG	18

Plug protective cap



Size 8
IP40

Part number: UTS68C

Plastic protective cap



Part numbers		Shell size
Receptacle cap	Plug cap	
8500-5585A	8500-5594	8
8500-5586A	8500-5595	10
8500-5587A	8500-5596	12
8500-5588A	8500-5597	14
8500-5590A	8500-5599	18



Cable assembly

Souriau provides connectors in various applications for more than 90 years in the most extreme environment.

Being conscious about the difficulty to find a quick and a reliable harness manufacturer, we decided years ago to start in house cable assembly production. It allows customers to reduce the number of suppliers, and to take advantage of the "best in class" quality of the Souriau group. Overmoulding is a process that further enhances the sealing properties of the UTS range, especially over many years of use. Overmoulding provides the opportunity to change the cable exit from straight through 90 degrees and avoid any stress on the cable terminated to the connector. Also, as the wires are encapsulated inside the moulding, a barrier is created which prevents from any liquid from entering the equipment through the connector if the cable jacket is breached.

In this section you'll find standard cable sets but as all customers are unique we are happy to adapt our proposal to your specific needs on demand.

Harnesses

Standard harnesses

Connector type	Backshell type	Gender	Connector size	Part number		
				1m of cable	3m of cable	5m of cable
UTS standard	Straight	Male	10 to 18	HAUTS - - PSTR100	HAUTS - - PSTR300	HAUTS - - PSTR500
		Female		HAUTS - - SSTR100	HAUTS - - SSTR300	HAUTS - - SSTR500
UTS Hi seal	Straight	Male	8 to 14	HAUTS - E - PSTR100	HAUTS - E - PSTR300	HAUTS - E - PSTR500
		Female		HAUTS - E - SSTR100	HAUTS - E - SSTR300	HAUTS - E - SSTR500

Overmoulded harnesses

Discrete connector

Overmoulded connector

Connector type	Backshell type	Gender	Connector size	Part number		
				1m of cable	3m of cable	5m of cable
UTS standard	Straight	Male	10 to 18	HAUTSOV - - PSTR100	HAUTSOV - - PSTR300	HAUTSOV - - PSTR500
		Female		HAUTSOV - - SSTR100	HAUTSOV - - SSTR300	HAUTSOV - - SSTR500
	90°	Male		HAUTSOV - - PRA100	HAUTSOV - - PRA300	HAUTSOV - - PRA500
		Female		HAUTSOV - - SRA100	HAUTSOV - - SRA300	HAUTSOV - - SRA500
UTS Hi seal	Straight	Male	8 to 14	HAUTSOV - E - PSTR100	HAUTSOV - E - PSTR300	HAUTSOV - E - PSTR500
		Female		HAUTSOV - E - SSTR100	HAUTSOV - E - SSTR300	HAUTSOV - E - SSTR500
	90°	Male		HAUTSOV - E - PRA100	HAUTSOV - E - PRA300	HAUTSOV - E - PRA500
		Female		HAUTSOV - E - SRA100	HAUTSOV - E - SRA30	HAUTSOV - E - SRA500

Other lengths and configurations: on demand, see factory
Note: UTS standard necessarily with gold plated stamped & formed contacts



UTS Series

Cable information

Range of temperature:	Occasional flexing: -5°C up to +70°C Fixed installation: -40°C up to +80°C
Rated voltage:	U0/U: 300/500 V
Wire section :	Arrangement with #16 contact: wire section 1.5 mm ² Arrangement with #20 contact: wire section 0.5 mm ²

Cable selection

Connector type		Number and size of wires	Cable used	
Shell size	Arrangement for UTS standard		Type	Harmonised reference
8	8E2	2 #20	2X0.5	H05 VV - F 2X0.5
	8E3; 8E3A; 8E33	3 #20	3X0.5	H05 VV - F 3X0.5
	8E4	4 #20	4X0.5	H05 VV - F 4X0.5
10	103PE	3 #16	3G1.5	H05 VV - F 3G1.5
	103	3 #16	3X1.5	H05 VV - F 3X1.5
	104	4 #16	4X1.5	H05 VV - F 4X1.5
	106; 1098	6 #20	7X0.5	H05 VV - F 7X0.5
	10E7	7 #20	7X0.5	H05 VV - F 7X0.5
	12E2	2 #16	2X1.5	H05 VV - F 2X1.5
12	12E3	3 #16	3X1.5	H05 VV - F 3X1.5
	124PE	4 #16	4G1.5	H05 VV - F 4G1.5
	128	8 #16	8X1.5	H05 VV - F 8X1.5
	12E8	8 #20	10G0.5	H05 VV - F 10G0.5
	1210	10 #20	10G0.5	H05 VV - F 10G0.5
	1214	14 #20	14G0.5	H05 VV - F 14G0.5
14	14E2	3 #8	3G10	H05 VV - F 3G10
	147PE	7 #16	7G1.5	H05 VV - F 7G1.5
	1412	12 #16	12X1.5	H05 VV - F 12X1.5
	14E12	8 #20; 4 #16	12G0.5	H05 VV - F 12G0.5
	14E15	14 #20; 1 #16	18G0.5	H05 VV - F 18G0.5
	14E18	18 #20	18G0.5	H05 VV - F 18G0.5
	1419	19 #20	21G0.5	H05 VV - F 21G0.5
18	18E11	11 #16	12X1.5	H05 VV - F 12X1.5
	1823	23 #16	25G1	H05 VV - F 25G1.5
	18E30	29 #20; 1 #16	30G0.5	H05 VV - F 30G0.5
	1832	32 #20	35G0.5	H05 VV - F 35G0.5

UNIT'S Series



UTS Series

Contacts

■ Description	40
■ Contact plating selector guide	41
■ Contact selector guide	42
■ Packaging	42
■ Crimp contacts	43
■ Coaxial contacts	45
■ PCB contacts	46
■ Fibre optic contacts	47



Contacts



Description

The UTS series offers the unique possibility to use the same contact in any layout as long as it receives the same active part size. Thus it is possible to buy only one contact reference and equip all connectors even if housings are different.

The main benefit is the standardisation which means reduction of inventory cost.

Bearing in mind that any additional tool or complicated assembly process should be avoided, our contacts are based on a snap-in principle which avoid the use of an insertion tool.

Crimp contacts are available in different versions:



• machined



• stamped & formed



• coaxial



• fiber optic

In addition, UTS series can obviously be equipped with solder contacts, PCB contacts, screw termination and RJ45.



UTS Series

Contact plating selector guide

As soon as you know what contact size you need, you next have to decide on which type to use.

Souriau proposes mainly two different types of electrical contacts:

- Machined
- Stamped & formed

Machined contacts are generally chosen for low quantities purpose as well as a better solution for power applications.

Stamped & formed contacts offer the ability to be crimped automatically which makes them more suitable for high volume production applications.

Then comes the question: What plating should I choose ?

Hereunder is a graph with criteria to guide you:

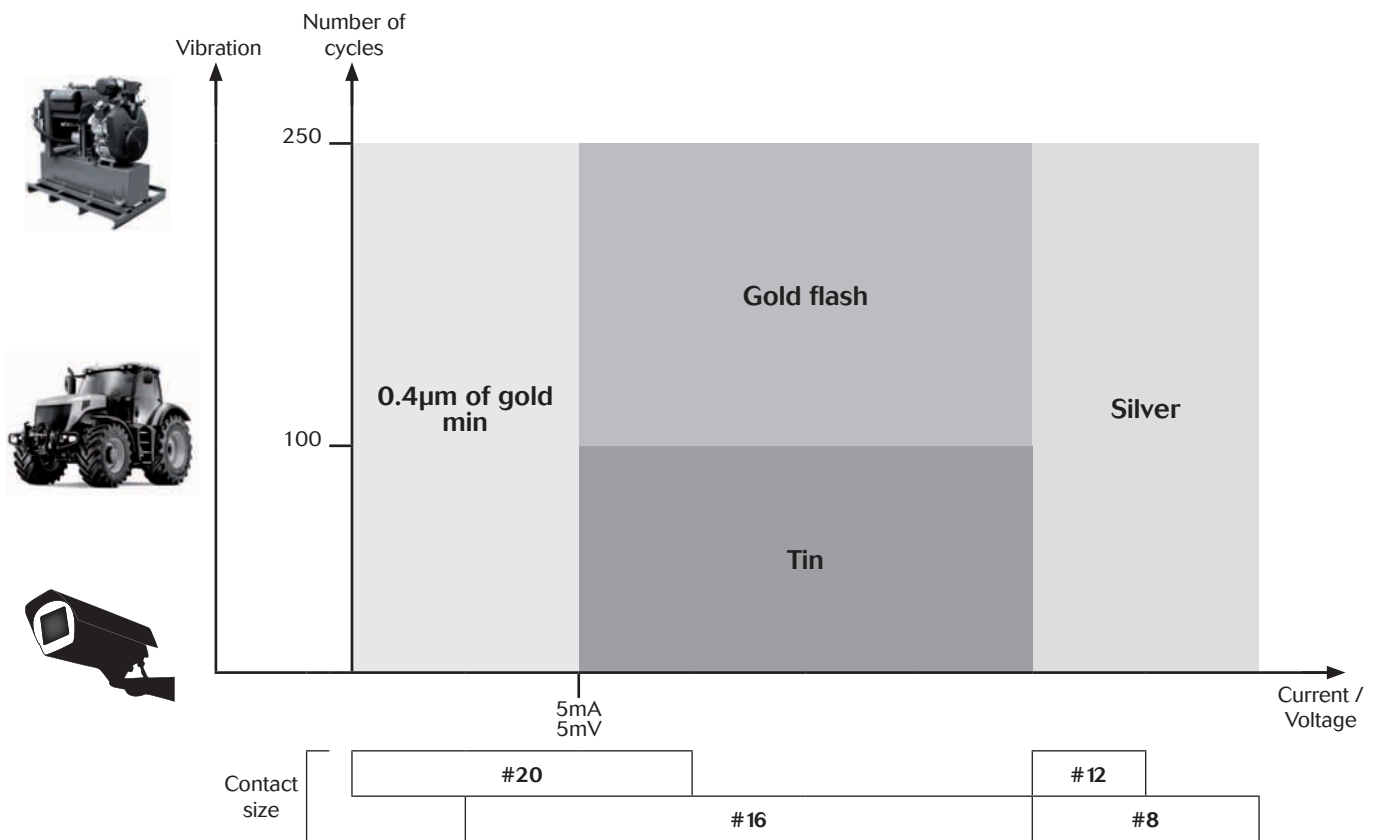



Contact selector guide

Electrical characteristics: contact resistance

#20 Ø1mm	Machined	< 6mΩ
	Stamped & formed	< 15mΩ
#16 Ø1.6mm	Machined	< 3mΩ
	Stamped & formed	< 6mΩ
#12 Ø2.4mm	Machined	< 5mΩ
#8 Ø3.6mm	Machined	< 5mΩ

Available platings

A	2μ Ni + 2μ Ag
J	Gold flash over 2μ Ni
K	Min 0.4μ gold over 2μ Ni
S31	Gold flash over Ni
S18	0.75μ gold min in active part over 2μ Ni Gold flash over Ni
S25 S26	Active part: 0.75μ Au over Ni Crimp area: flash Au over Ni
T	T: 2μm Ni mini all over + 3 to 5 μm Sn all over
TK6	2-5μ Sn pre-plated

Packaging

Conscious of the wide variety of applications, contact packaging has been considered for small series (bulk packaging) and high volume production (reeled contacts):



• 50 pieces bulk packing (standard)



• 1000 pieces bulk packing

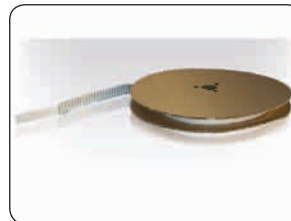

• 3000 pieces reeled stamped & formed contacts



• 5000 pieces reeled machined contacts



Crimp contacts

Standard version



Contact size	Type	Wire size		Part number		Max wire Ø	Max insulator Ø	Color band		Plating available
		AWG	mm ²	Male	Female			Front	Rear	
#20 Ø1 mm	Machined	26-24	0.13-0.20	RM24W3-	RC24W3-		1.58 max	-	-	K
	S&F	26-24	0.13-0.25	SM24W3S26 (1) SM24WL3S26 (2)	SC24W3S25 (1) SC24WL3S25 (2)		0.89-1.58	-	-	S25, S26
	Machined	22-20	0.32-0.52	RM20W3-	RC20W3-		1.58 max	-	-	K
	S&F	22-20	0.35-0.5	SM20W3S26 (1) SM20WL3S26 (2)	SC20W3S25 (1) SC20WL3S25 (2)		1.17-2.08	-	-	S25, S26
	Machined	20-18	0.50-0.93	RM18W3-	RC18W3-		2.10 max	-	-	K
#16 Ø1.6 mm	Machined	30-28	0.05-0.08	RM28M1-	RC28M1-	0.55	1.1	-	-	K, J, T
	Machined	26-24	0.13-0.2	RM24M9-	RC24M9-	0.8	1.6	Red	-	K, J, T
	S&F	26-24	0.13-0.25	SM24M1- (1) SM24ML1- (2)	SC24M1- (1) SC24ML1- (2)	0.89-1.28		-	-	S31, S18, TK6
	Machined	22-20	0.32-0.52	RM20M13-	RC20M13-	1.18	1.8	Black	-	K, J, T
				RM20M12-	RC20M12-		2.2	Blue		
	S&F	22-20	0.35-0.5	SM20M1- (1) SM20ML1- (2)	SC20M1- (1) SC20ML1- (2)	1.17-2.08		-	-	S31, S18, TK6
	Machined	20-16	0.52-1.5	RM16M23-	RC16M23-	1.8	3.2	-	-	K, J, T
	S&F	18-16	0.8-1.5	SM16M1- (1) SM16ML1- (2)	SC16M1- (1) SC16ML1- (2)	3.0		-	-	S31, S18, TK6
	S&F	18-16	0.8-1.5	SM16M11- (1) SM16ML11- (2)	SC16M11- (1) SC16ML11- (2)	2.0-3.0		-	-	S31, S18, TK6
	Machined	16-14	1.5-2.5	RM14M50-	RC14M50-	2.05	3.2	-	-	K, J, T
	Machined	16-14	1.5-2.5	RM14M30-	RC14M30-	2.28	3.2	-	-	K, J, T
S&F	14	2.0	SM14M1- (1) SM14ML1- (2)	SC14M1- (1) SC14ML1- (2)	3.2		-	-	S31, S18, TK6	
#12 Ø2.4 mm	Machined	22	0.13-0.4	8291 1457N-	8291 1456-	-	4.9	-	-	A, K
		20	0.5	8291 1459N-	8291 1458-					
		18	0.75-1.0	8291 1461N-	8291 1460-					
		16	1.5	8291 1463N-	8291 1462-					
		14	2.5	8291 1465N-	8291 1464-					
		12	4	8291 1467N-	8291 1466-					
#8 Ø3.6 mm	Machined	16	1.5	8291 3601-	8291 3600-	-	6.5	-	-	A
		14	2.5	8291 3603-	8291 3602-					
		12	4	8291 3605-	8291 3604-					
		10	6.0	8291 3607-	8291 3606-					
		8	10.0	8291 3609-	8291 3608-					

(1) contact reeled
(2) loose contact



Crimp contacts

First Mate Last Break contacts

Contact size	Type	Wire size		Part number		Max wire Ø	Max insulator Ø	Color band		Plating available
		AWG	mm ²	Male	Female			Front	Rear	
# 16 Ø1.6 mm Longer male contact (+1mm)	Machined	30-28	0.05-0.08	RM28M1GE1□	-	0.55	1.1	-	Red	□ = K, J or T
		26-24	0.13-0.2	RM24M9GE1□		0.8	1.6	Red	Red	
		22-20	0.32-0.52	RM20M13GE1□		1.18	1.8	Black	Red	
				RM20M12 GE1□			2.2	Blue	Red	
		20-16	0.52-1.5	RM16M23 GE1□		1.8	3.2	-	Red	
		16-14	1.5-2.5	RM14M50 GE1□		2.05	-	-	Red	
16-14	1.5-2.5	RM14M30 GE1□	2.28	-	-	Red				
# 16 Ø1.6 mm Shorter female contact (-0.7mm)	Machined	30-28	0.05-0.08	-	RC28M1GE7□	0.55	1.1	-	Blue	□ = K, J or T
		26-24	0.13-0.2		RC24M9GE7□	0.8	1.6	Red	Blue	
		22-20	0.32-0.52		RC20M13GE7□	1.18	1.8	Black	Blue	
					RC20M12GE7□		2.2	Blue	Blue	
		20-16	0.52-1.5		RC16M23GE7□	1.8	3.2	-	Blue	
		16-14	1.5-2.5		RC14M50GE7□	2.05	-	-	Blue	
16-14	1.5-2.5	RC14M30GE7□	2.28	-	-	Blue				

How to make FMLB / LMFB connection

Contact 1 \ Contact 2	Standard male contact	Standard female contact	Longer male contact
Standard male contact		✓	
Standard female contact	✓		✓ FMLB
Shorter female contact	✓ LMFB		

First Mate Last Break contacts should be chosen only if the cavity is not marked with the earth symbol. For cavities marked with the earth symbol, standard contacts will fulfill the same role as a first mate, last break contact used in a standard cavity.



Ground symbol



UTS Series

Coaxial contacts

Coaxial contact range

We provide 2 types of coaxial contacts suitable for 50 or 75Ω, coaxial cable or twisted pair cable.

Monocrimp coaxial contact

- The monocrimp one-piece coaxial contacts offer high reliability plus the economic advantage of a 95% reduction in installation time over conventional assembly methods.
- This economy is achieved by simultaneously crimping both the inner conductor and outer braid or drain wire.



Multipiece crimp coaxial contact

- The inner conductor and outer braid is crimped individually.
- The thermoplastic insulating bushing in the outer body is designed to accept and permanently retain the inner contact.
- An outer ferrule is used to connect the braid to the outer contact and provide cable support to ensure against bending and vibration.



Suitable for Coaxial cable or Twisted cable

- For jacket diameter from 1.78 to 3.05mm
Inner conductor up to 2.44mm diameter



- For jacket diameter from 0.64 to 1.45mm
Inner conductor from AWG30 to AWG24



Contacts for coaxial cable summary

Contact type	Contact range		Contact part number with cable combination	Cabling notice
	Male contact	Female contact		
Multipiece	RMDXK10D28	RCDXK1D28	See page 68	See pages 72 & 73
Monocrimp	RMDX60xxD28	RCDX60xxD28		See page 74

Contacts for twisted pairs cable summary

Contact type	Contact range		Contact part number with cable combination	Cabling notice
	Male contact	Female contact		
Multipiece	RMDXK10D28 + YORK090	RCDXK1D28 + YORK090	See page 69	See page 70
Monocrimp	RMDX60xxD28	RCDX60xxD28		See page 71



PCB contacts

PCB contacts

PCB soldering

UTS range can be carried out with a wave soldering process, but not reflow soldering process. All high temperature processes are prohibited.



Contact size	Type	Part number		Plating
		Male	Female	
#20 Ø1mm	Short version	RMW50A7□	RCW50A7□	□ = K
	Long version	RMW5016□	RCW5016□	
#16 Ø1.6mm	Short version	RM20M12E8□	RC20M12E8□	□ = K or T
	Long version	RM20M12E83□	RC20M12E83□	
			RC20M12E84□	



UTS Series

Fibre optic contacts

Description

Size 16 Fibre optic contacts for TRIM TRIO® connectors

Size 16 Fibre optic contacts are optical contacts designed for the integration of optical links in all TRIM TRIO® cable connectors.

The Fibre optic contacts are designed to accommodate:

- Plastic Optical Fibre (POF)
 - 1 mm core and 2.2 mm jacket
- Plastic Clad Fibre (PCF)
 - 230µm core and 2.2 mm jacket
- Multimode Silica Fibre
 - 62.5/125µm type 2.0 mm max. jacket
- Singlemode Silica Fibre
 - 9/125µm type 2.0 mm jacket



Typical features and benefits are:

- Socket contact is spring loaded to avoid any air gap between the two optical faces.
- Low insertion loss is provided by high precision pieces.
- Single jumpers, multiway harness and active device housings can be supplied regarding customer requirement.

Technical characteristics

Performance

• Fibre type:	POF/PCF	Multimode 62.5/125µm	Singlemode 9/125µm
• Wave length:	650 nm	1300 nm	1310 nm
• Optical insertion loss (typ.):	2 dB max.	< 0.5 dB	< 0.35 dB
• Jacketed external diameter:	2.2mm	2.0mm max.	2.0mm max.
• Temperature range:	-25°C to +70°C	-25°C to +70°C	-25°C to +70°C
• Cable retention:	49N		
• Mating cycles without cleaning:	50		
• Max. mating cycles:	500		

Construction

- Contact body: Copper alloy

Connector accommodation

Any TRIM TRIO® size 16 contact can be used in any contact position in any connector in the TRIM TRIO® size 16 interconnection system : UTP, UTS, UTG, UTO.



Fibre optic contacts

Ordering information

POF Contacts (Plastic Optical Fibre)

Male contact	RMPOF1000
Female contact	RCPOF1000B

PCF Contacts (Plastic Clad Fibre)

Male contact	RMPCF230
Female contact	RCPCF230B

Silica Contacts - Multimode

Male contact	RMMMOFA
Female contact	RCMMOFA

Silica Contacts - Monomode

Male contact	RMSMOFA
Female contact	RCSMOFA

POF Contact (Plastic Optical Fibre)

STANDARD TOOLING KIT - P/N 80MS0004

The *standard tooling kit* is made of the part numbers below that can be ordered separately as well.

Part numbers	Descriptions
80WD0005	Stripping tool
80WD0025	Automatic stripping tool for Ø 0.5 mm, 0.6 mm, 0.7 mm & 3.8 mm
80WM0006	Ruler
80WP0005	Polishing plate
80WP0013	Non slip base (to hold the polishing plate)
80WP0014	Polishing disk (grain size 9µm)
80WP0018	Polishing tool
80WP0019	Polishing disk (grain size 30µm)
80WS0002	Crimping plier

SPECIFIC TOOLING LIST - can be ordered only separately

Part numbers	Descriptions
80WG0010	Needle
80WG0015	Capsule
80WG0016	Syringe
80WN0005	Dry air spray
80WN0006	Optical paper
80WN0012	Dropping bottle
80WN0008	Wiping solvent

PCF Contact (Plastic Clad Fibre)

STANDARD TOOLING KIT - P/N 80MG0039

Descriptions
Stripping tool for Ø 2.2 mm
Kevlar scissors
Stripping tool for Ø 0.25 mm
Alumina blade
Polishing tool
Press fit tool
Microscope

Descriptions
Polishing disk (grain size 9µm)
Polishing disk (grain size 0.3µm)
Curing oven
Polishing plate
Non slip base (to hold the polishing plate)
Glue



UTS Series

Fibre optic contacts

Multimode Contact - Silica

STANDARD TOOLING KIT - P/N 80MG0027

The *standard tooling kit* is made of the part numbers below that can be ordered separately as well.

Part numbers	Descriptions
80WC0001	Aramid yarn scissors
80WC0003	Cutter
80WC0004	Alumina blade
80WD0008	Stripping tool for Ø 0.20 mm
80WD0010	Stripping tool for Ø 0.25 mm
80WD0014	Stripping tool for Ø 0.60 mm
80WD0025	Automatic stripping tool for Ø 0.5 mm, 0.6 mm, 0.7 mm & 3.8 mm
80WM0006	Ruler
80WP0005	Polishing plate
80WP0013	Non slip base (to hold the polishing plate)
80WT0008	Curing oven
80WT0009	Protective tube

SPECIFIC TOOLING LIST - can be ordered only separately

Part numbers	Descriptions
80WD0036	Stripping tool for Ø 0.9 mm & 0.25 mm
80WD0005	Stripping tool for Ø 2.2 mm & 1.5 mm
80WL0001	Microscope x400
80WL0008	Microscope adaptor
80WP0025	Polishing tool
80WS0002	Crimping tool
80WT0005	Contact support for polymerisation
80WG0010	Needle
80WG0014	Glue
80WG0015	Capsule
80WG0016	Syringe
80WN0005	Dry air spray
80WN0006	Optical paper
80WN0012	Dropping bottle
80WP0014	Polishing disk (grain size 9µm)
80WP0015	Polishing disk (grain size 0.3µm)

UNIT'S Series



Technical information

■ Tooling	52
■ Assembly instruction	54
■ Rated current & working voltage	58
■ UV resistance	59
■ Crimping	59
■ UL94 + UL1977	60
■ IEC 61984 and IP codes explained	63
■ What is NEMA rating ?	65



Tooling

Automatic crimping tools

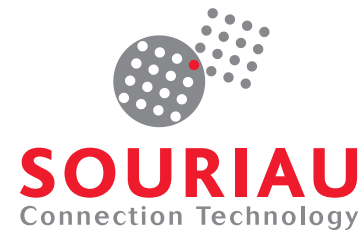

Mecal is leader in manufacturing tooling for crimping terminals over a stripped wire.

Established in 1976, Mecal has become one of the world's leading companies dedicated to the design and manufacture of semi automatic production tools for strip fed, open barrel crimp terminals, serving the Automotive, Telecom and Datacomm industry.

The extreme environment interconnect specialist "from deep sea to deep space".

Souriau designs manufactures and markets high performance interconnect solutions for severe environments dedicated to the aerospace, defence, light and heavy industry markets.

Souriau has been working in partnership with Mecal for a good number of years. With sales offices located in all major industrial regions of the world, the combined strengths of both organisations has resulted in a truly global solution to all your production tooling needs.

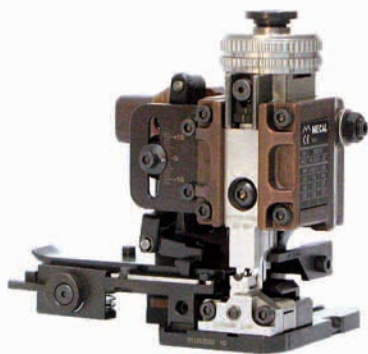

Mini Applicator

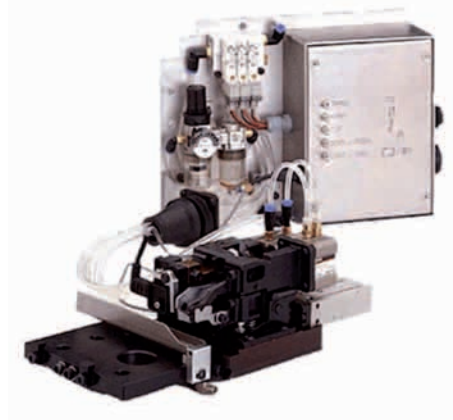

Stripper



Presses

Mecal sales network:

www.mecal.net/eng/retevendita.php



Crimptooling table

Standard contacts

Contact size	Part number	Head	Handles
#20 1mm	RM/RC 24W3 -	S20RM	HANDLES
	RM/RC 20W3 -		
	RM/RC 18W3 -		
	SM 24W3S - (1) SC 24W3S - (1)	S20SCM20	
	SM 24WL3S - (2) SC 24WL3S - (2)		
SM/SC 20W3S - (1) SM/SC 20WL3S - (2)	S16RCM20		
RM/RC 28M1 -			
RM/RC 24M9 -			
RM/RC 20M13 -			
RM/RC 20M12 -			
RM/RC 16M23 -		S16RCM16	
RM/RC 14M50 -		S16RCM1450	
RM/RC 14M30 -		S16RCM14	
SM/SC 24M1 - SM/SC 24ML1 -		S16SCM20	
SM/SC 20M1 - SM/SC 20ML1 -			
SM/SC 16M1 - SM/SC 16ML1 -	S16SCML1		
SM/SC 14M1 - SM/SC 14ML1 -			
SM/SC 16M11 - SM/SC 16ML11 -	S16SCML11		



Contact size	Part number	Tool with separate locator			Extraction tools
		Hand tool	Positioner + locator setting		
#12 2.4mm	8291 1457N- / 8291 1456-	M317	VGE10077A	1-2	5106 02 09 24
	8291 1459N- / 8291 1458-			2	
	8291 1461N- / 8291 1460-			2	
	8291 1463N- / 8291 1462-			3	
	8291 1465N- / 8291 1464-			3	
	8291 1467N- / 8291 1466-			4	
#8 3.6mm	8291 3601A / 8291 3600A	M317	VGE10078A	3	5106 021 09 36
	8291 3603A / 8291 3602A			3	
	8291 3605A / 8291 3604A			4	
	8291 3607A / 8291 3606A			5	
	8291 3609A / 8291 3608A			6/7	

Specific contacts

Contact size	Part number	Hand tools (HANDLES) head	Tool with separate locator			Extraction tools
			Hand tool	Positioner + locator setting		
#16 Ø 1.6mm Longer RM contact	RM28M1GE1-	S16RCM20	MH860	MH861686	4/6	RX2025GE1
	RM24M9GE1-				5/6	
	RM20M13GE1-				6/7	
	RM16M23 GE1-	S16RCM16	M317	UH2-5	6/8	
	RM14M50 GE1-	S16RCM1450			3	
	RM14M30 GE1-	S16RCM14				
#16 Ø 1.6mm Shorter RC contact	RC28M1GE7-	S16RCM20	MH860	MH861646	4/6	
	RC24M9GE7-				5/6	
	RC20M13GE7- RC20M12GE7-				5/7	
	RC16M23GE7-	S16RCM16	M317	UH2-5	6/8	
	RC14M50GE7-	S16RCM1450			3	
	RC14M30GE7-	S16RCM14				

Coaxial contacts

See cabling notice pages 68 to 74.



Assembly instruction

Wire stripping

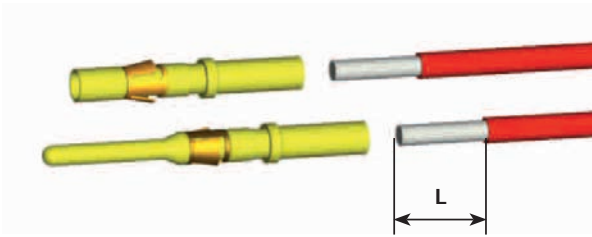

Part number		Stripping length L (mm)
Male	Female	
Screw contacts		
Contact delivered with connector		5.8
Power contacts #12		
8291 1457 -	8291 1456 -	7 to 8
8291 1459 -	8291 1458 -	
8291 1461 -	8291 1460 -	
8291 1463 -	8291 1462 -	
8291 1465 -	8291 1464 -	
8291 1467 -	8291 1466 -	
Power contacts #8		
8291 3601 -	8291 3600 -	6.5 to 7.5
8291 3603 -	8291 3602 -	
8291 3605 -	8291 3604 -	
8291 3607 -	8291 3606 -	
8291 3609 -	8291 3608 -	

Part number		Stripping length L (mm)
Male	Female	
Machined contact #16		
RM28M1- RM24M9- RM20M13- RM20M12-	RC28M1- RC24M9- RC20M13- RC20M12-	4.8
RM16M23- RM14M50- RM14M30-	RC16M23- RC14M50- RC14M30-	7.1
Stamped & formed contact #16		
SM24M1- SM24ML1- SM20M1- SM20ML1-	SC24M1- SC24ML1- SC20M1- SC20ML1-	4
SM16M1- SM16ML1-	SC16M1- SC16ML1-	6.35
SM16M11- SM16ML11-	SC16M11- SC16ML11-	4.65
SM14M1- SM14ML1-	SC16M11- SC16ML11-	6.35
Machined contacts #20		
RM24W3- RM20W3- RM18W3-	RC24W3- RC20W3- RC18W3-	4.8
Stamped & formed contact #20		
SM24W3- SM24WL3- SM20W3- SM20WL3-	SC24W3- SC24WL3- SC20W3- SC20WL3-	4

UTS 7 assembly (mounting suggestion)

- Strip wires, crimp contacts
- Insert contacts into connector cavities (insert manually or use tool RTM205)
- Seat o-ring, place receptacle in the panel cut-out
- Tighten jam nut

Shell size	Jam nut torque (Nm)	Ø Wire	
		Standard version	Discrete wire sealing
8	1.5	3.2 mm max.	from 1.7 mm to 3.0 mm
10	3		
12	4		
14	5		
18	5		

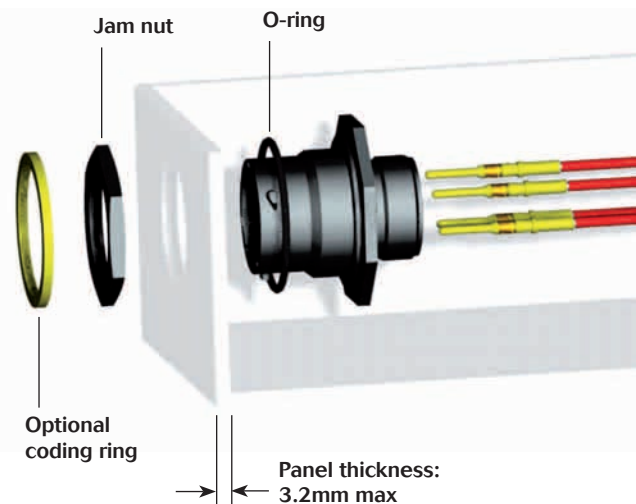



UTS Series

UTS 0 assembly (mounting suggestion)

- Strip wires, crimp contacts
- Insert contacts into connector cavities (insert manually or use tool RTM205)
- Place receptacle in the panel cut-out, with optional gasket
- Secure receptacle with screws (not supplied)

Front mounting

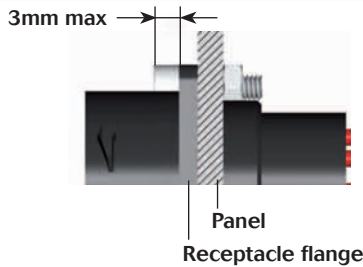
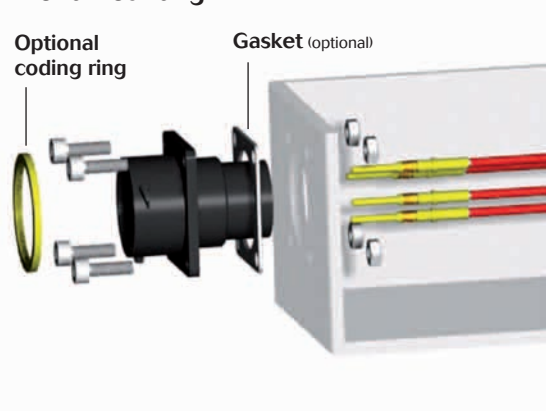

Rear mounting

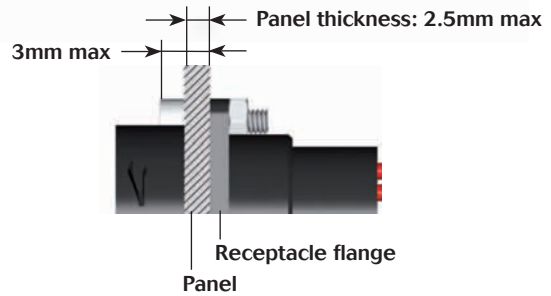
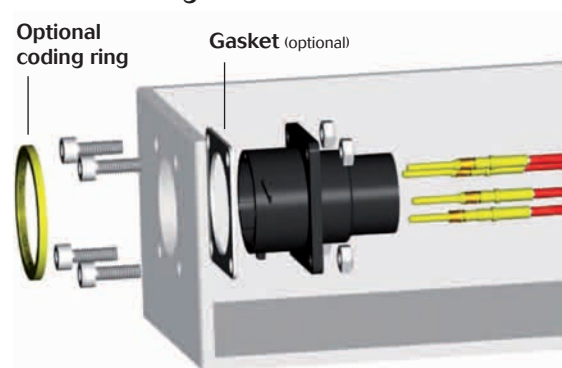

UTS 6 GN / UTS 7 GN assembly

- Slide accessories on the cable (make sure to keep compression ring on the grommet)
- Strip wires and crimp contacts
- Insert first contact into the grommet (first contact in cavity A, use male contact to pierce the grommet, no tool is required), then insert the contact in the connector cavity A (insert manually or use tool RTM205)
- Place the grommet and compression ring on the insulator
- Insert the other contacts
- Tighten nut (recommended torque: see note)

Shell size	Nut tightening torque (Nm)	Ø Wire
10	1	from 1.7 mm to 3.0 mm
12	1.5	
14	1.5	

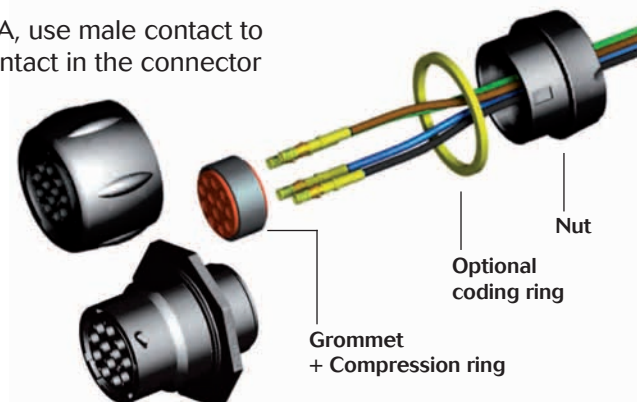



Assembly instruction

UTS 1 JC / UTS 6 JC assembly

- Slide accessories on the cable

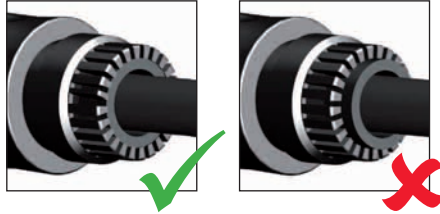

Make sure the rubber gasket is positioned as shown.

- Strip external cable jacket
- Strip wires and crimp contacts
- Insert contacts into connector cavities (insert manually or use tool RTM205)
- Tighten adaptor with plug, tighten nut with adaptor (recommended torque values to be applied according to the table - right)

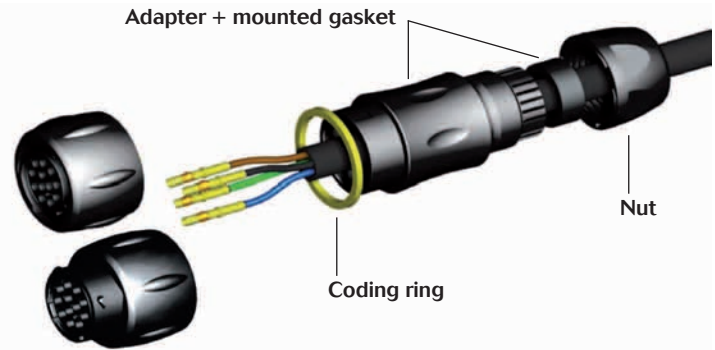

Shell size	Recommended jacket strip length (mm)		Adapter tightening torque (Nm)	Nut tightening torque (Nm)	Ø Cable range Standard seal	Ø Cable range Reducing seal	Ø Wire
	Male	Female					
8	(17)	(25)	1	0.75	2.5/6.5	1.5/5.0	3.2 mm max.
10	21	29	1.5	2	2.5/8.0	1.5/5.0	
12	25	33	2	2.5	5.0/12.0	3.0/9.0	
14	29	36	3	2.5	7.0/14.0	5.0/12.0	
18	37	45	4	3.5	9.0/18.0	7.0/16.0	

UTS 1 GJC / UTS 6 GJC assembly

- Slide accessories on the cable (make sure to keep compression ring on the grommet)
- Strip external cable jacket
- Strip wires and crimp contacts
- Insert first contact into the grommet (first contact in cavity A, the contact pierces the grommet, no tool is required), then insert the contact in the connector cavity A (insert manually or use tool RTM205)
- Place the grommet and compression ring on the insulator
- Insert the other contacts
- Tight adapter with plug, tight nut with adaptater (recommended torque values to be applied according to the table - right)

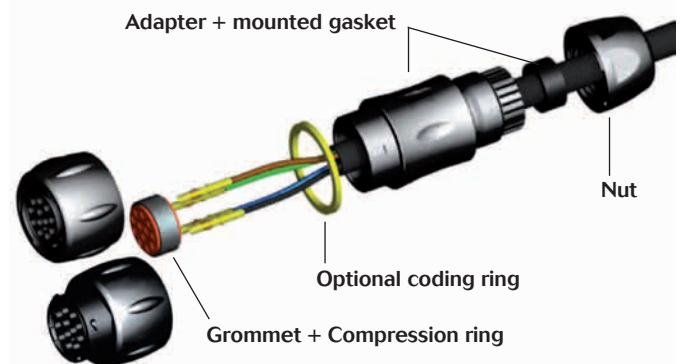

Shell size	Recommended jacket strip length (mm)		Adapter tightening torque (Nm)	Nut tightening torque (Nm)	Ø Cable range Standard seal	Ø Cable range Reducing seal	Ø Wire
	Male	Female					
8	(17)	(25)	1	0.75	2.5/6.5	1.5/5.0	from 1.7 mm to 3.0 mm
10	21	29	1.5	2	2.5/8.0	1.5/5.0	
12	25	33	2	2.5	5.0/12.0	3.0/9.0	
14	29	36	3	2.5	7.0/14.0	5.0/12.0	
18	37	45	4	3.5	9.0/18.0	7.0/16.0	



UTS Series

Mated connector length

UTS0 + UTS6

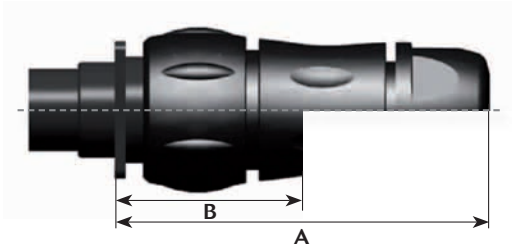

UTS7 + UTS6

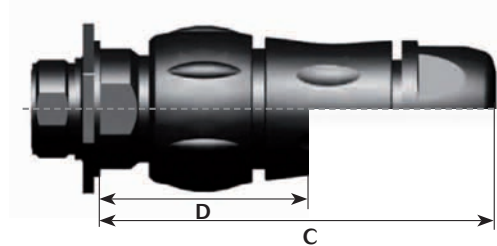

Shell size	UTS0 + UTS6 EN JC & CJC	UTS0 + UTS6 EN GN	UTS7 + UTS6 EN JC & CJC	UTS7 + UTS6 EN GN
	A max	B max	C max	D max
10	73.2	39.6	77.3	43.7
12	77.6	39.4	81.7	43.5
14	83.5	40	87.6	44.1
18	93.1	-	97.2	-

Panel cut out

UTS0

Square flange receptacle

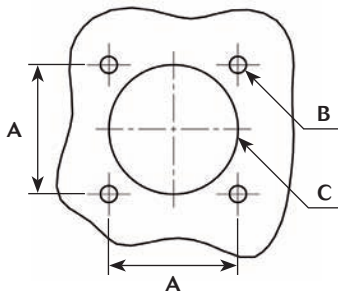

UTS7

Jam nut receptacle

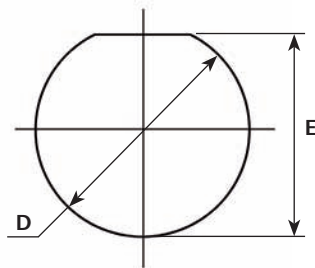

Shell size	A ^{±0.25}	Ø B ^{±0.1}	Ø C ^{±0.1}		Ø D ^{±0.2}	E ^{±0.2}
			Front mounting	Rear mounting		
8	15.1	3.2	12.5	14.5	14.6	13.75
10	18.3		15.1	17.8	17.7	16.5
12	20.6		18.2	22.2	22.5	21.2
14	23.0		21.4	25.5	25.7	24.3
18	27.0		27.8	31.8	32	30.6

Contact extraction for size 16 & size 20 contacts

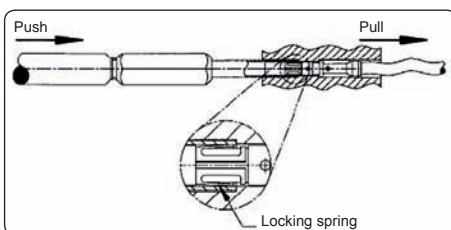

How to remove a contact out of its cavity?

First of all, if the connector is fitted with a backshell, unscrew it and slide it up the cable. Slide the extraction tip over contact from mating side and push it all the way into the connector cavity until it stops, indicating that the locking spring from the contact is depressed.

Push on handle to activate the sprung loaded inner plunger to extract the contact from the rear of the connector.

Note : all dimensions are in mm



Rated current & working voltage

Current carrying capacity

The current carrying capacity of a connector is limited by the thermal properties of materials used in its construction. The amount of current that can be handled depends on the size of cable used, the ambient temperature and the heat that is generated inside the connector. Part 3 of the IEC 60512 standard determines through a derating curve, the maximum current permissible, which varies from one layout to another (Fig.1 & Fig.2). Wire size plays an important role as well, since they help to dissipate heat and avoid overheating (Fig.1 & Fig.3).

Please note that the curve should be adjusted when dealing with potential hot spots, which can occur as a result of unequal loading of current across a number of contacts. As a general rule, it is best to avoid locating power handling contacts in the middle of the connector; try to locate them towards the edge where heat can be dissipated more effectively. Eventually you should find a level which represents the permissible operating range:

Fig.1: UTS 12-4 – 1.5mm² wires

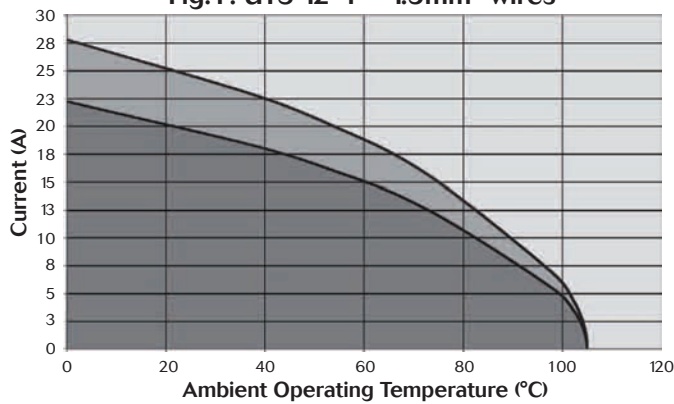

Fig.2: UTS 12-8 – 1.5mm² wires

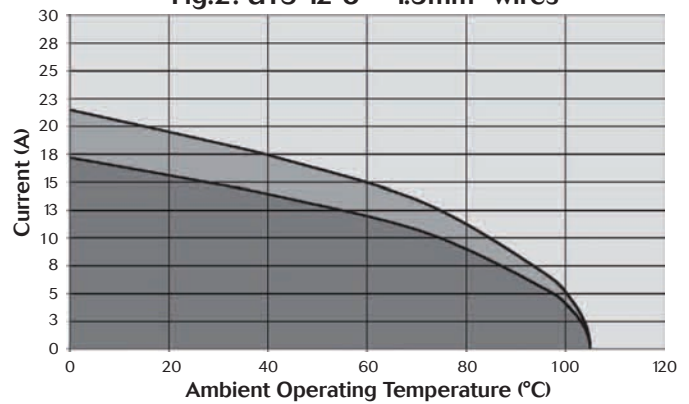
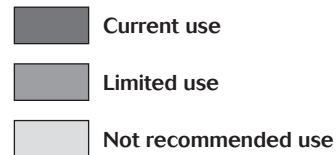
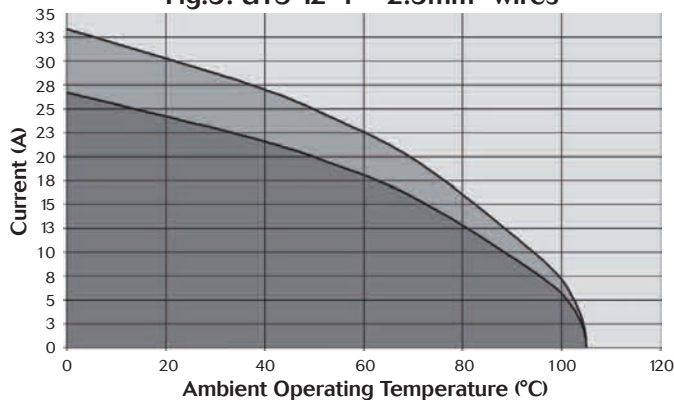

Fig.3: UTS 12-4 – 2.5mm² wires



The **rated current** is defined as uninterrupted continuous current that a connector can take when all contacts are energized simultaneously without exceeding the maximum limit of temperature. The earth contact is never loaded.



UTS Series

UV resistance

Solar radiation affects all materials, but plastics can be susceptible to extreme degradation over time. The choice of materials for the UTS series was therefore a critical consideration.

All over the world we are not exposed to the same amount of energy given by the sun. The chart shown here clearly illustrates this.

So we performed test according to the ISO 4892-2 and simulated 5 years exposure to outdoor environments (temperature, humidity, etc...)

After this period there was no significant colour variation, no crazing, no cracking and no major variation of mechanical properties.

Yearly mean of daily irradiation in UV (280-400 nm) on horizontal plane (J/cm²) (1990-2004)

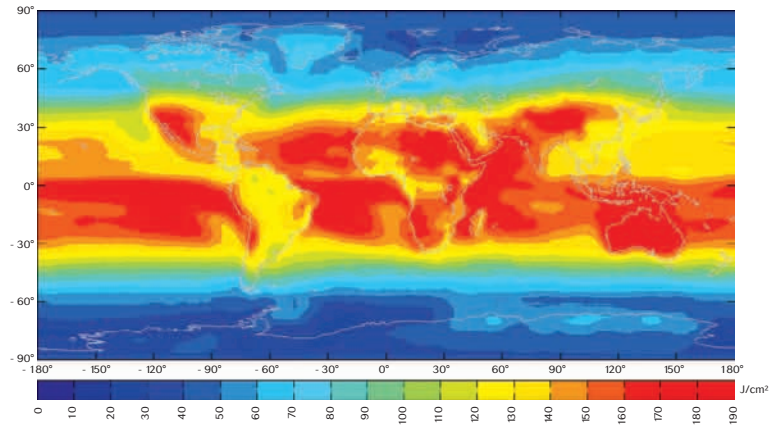

Crimping

One of the key factors which affects the performance of a connector, is the way contacts are terminated. Crimped connections are nowadays seen as the best solution to ensure quality throughout the lifetime of the product. Here are some reasons why we recommend this method of termination for UTS connectors:

Advantages (Extract from the IEC 60352-2):

- Efficient processing of connections at each production level
- Processing by fully-automatic or semi- automatic crimping machines, or with hand operated tools
- No cold-soldered joints
- No degradation of the spring characteristic of female contacts by the soldering temperature
- No health risk from heavy metal and flux steam
- Preservation of conductor flexibility behind the crimped connection
- No burnt, discolored and overheated wire insulation
- Good connections with reproducible electrical and mechanical performances
- Easy production control

To ensure that the crimp tooling is performing according to original specifications, it is important to carry out regular checks. A common way to check the performance of tooling is with a simple pull test, ideally using a dedicated electric pull tester. Minimum recommended full forces are indicated in the tables below:

Conductor cross-section		Pull out force
MM ²	AWG	N
0.05	30	6
0.08	28	11
0.12	26	15
0.14		18
0.22	24	28
0.25		32
0.32	22	40
0.5	20	60
0.75		85
0.82	18	90
1.0		108

Conductor cross-section		Pull out force
MM ²	AWG	N
1.3	16	135
1.5		150
2.1	14	200
2.5		230
3.3	12	275
4.0		310
5.3	10	355
6.0		360
8.4	8	370
10.0		380



There are two main standards for industrial connectors: UL94 & UL1977

UL94

This standard is dedicated to plastics flammability. It characterises how the material burns in various orientation and thicknesses.

The UTS series has been rated at **V-0** & **HB**.

Procedure: A specimen is supported in a vertical or horizontal position and a flame is applied to the bottom of the specimen. The flame is applied for ten seconds and then removed until flaming stops, at which time the flame is reapplied for another ten seconds and then removed. Two sets of five specimens are tested. The two sets are conditioned under different conditions.

V-0 :

- Specimens must not burn with flaming combustion for more than 10 seconds after either test flame application.
- Total flaming combustion time must not exceed 50 seconds for each set of 5 specimens.
- Specimens must not burn with flaming or glowing combustion up to the specimen holding clamp.
- Specimens must not drip flaming particles that ignite the cotton.
- No specimen can have glowing combustion remain for longer than 30 seconds after removal of the test flame.

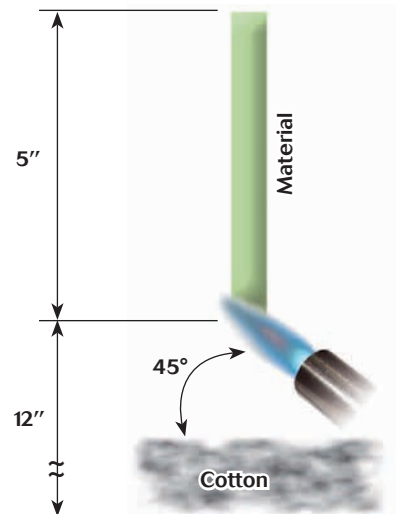

HB :

- A material classed HB shall not have a burning rate exceeding 40 mm per minute over a 75 mm span for specimens having a thickness of 3.0 to 13 mm.
- A material classed HB shall not have a burning rate exceeding 75 mm per minute over a 75 mm span for specimens having a thickness less than 3.0 mm.
- A material classed HB shall cease to burn before the 100 mm reference mark.

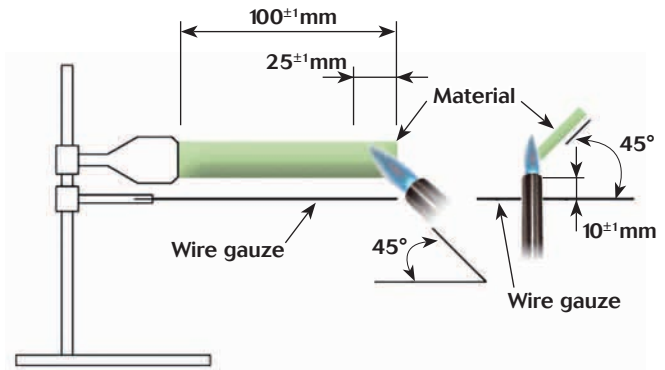



UTS Series

UL 1977

There are several standards which deal with plug and receptacle. Each of them is only for a small area of applications. It could be telecommunication, Etc. The UL 1977 covers single and multipole connectors intended for factory assembly.

Requirements apply to devices in taking into account intensity and voltage. There are categories as follows:

	0	30 V (42 V peak)	600 V
0	Type 0		Type 1A
8.3 A	Type 1B		Type 2
31 A			Type 3
200 A	Type 4		
1000 A			

According to above table, the level of performance that has to be reached could be different. Most of them are explained in the following page.

Insulating materials:

Material uses for electrical insulation, as a minimum, have to comply with the characteristics shown below:

• Minimum ratings for polymeric materials

Type	Flame rating	Relative thermal index (RTI) Electrical/mechanical w/o impact **/**
0	-	50/50
1A	HB	50/50
1B	HB	50/50
2	HB	50/50
3	HB	50/50
4	HB	50/50

* The RTI of the material shall not be lower than the temperature measured during the Temperature Test.

** For a thickness less than that for which a value has been established, the RTI of the minimum thickness with an established value shall be used.

Assembly:

Connector has to be keyed to prevent any mismatching that can damage the machine or hurt the user. In the same way, plugs and sockets have to be equipped to protect persons against contact with live parts.

Finally the identified grounding contact shall be located so that the corresponding electrical continuity has to be completed before any other contact.



UL1977

Spacing:

For a 250V max connector, distance through air or over material shall be 1.2mm whereas from 250V to 600V connector the spacing is 3.2 minimum. These distances have to be taken between uninsulated live parts as shown in the matrix below:

• **Applicability of spacing requirements**

Type	Uninsulated live part - uninsulated live part of opposite polarity	Uninsulated live part - uninsulated grounded metal part	Uninsulated live part - exposed dead metal part
0	No	No	No
1A	Yes	Yes	Yes
1B	Yes	Yes	No
2	Yes	Yes	Yes
3	Yes	Yes	Yes
4	Yes	Yes	Yes

An alternative way to determine voltage rating is with the Dielectric-Withstand test. If during one minute there is no arc-over or breakdown the rated voltage is given as given below:

- a) 500 volts for a type 1B device
- b) 1000 volts plus twice rated voltage for types 1A, 2, 3 and 4 devices.

Marking:

A device shall be legibly marked with the manufacturer's trade name, trade mark, or other descriptive marking by which the organisation responsible for the product may be identified. (Exception: If the device is too small, or where the legibility would be difficult to attain, the manufacturer's name, trademark, or other descriptive marking may appear on the smallest unit container or carton)

The following shall be marked on the device or on the smallest unit container or carton or on a stuffer sheet in the smallest unit container or carton:

- a) The catalogue number or an equivalent designation
- b) The electrical rating in both volts and amperes, if assigned
- c) Whether ac or dc, if restricted
- d) Flammability class, if identified

Example - Marking for the arrangement 10-3: 



UTS Series

IEC 61984

The norm is dedicated to connectors with rated voltage above 50V and up to 1000V and rated currents up to 125A per contact. But depending of your application connectors should be compliant with another standard. This has to be double checked with the customer.

There are lot of constructional requirements and performances specified in that standard. Most of them are illustrated in greater details hereafter.

Provisions for earthing:

The UTS connector is intended to be used on Class II systems. Even if the purpose of our connector is not to interrupt current, we often see a need to add a protective earth contact. Then this one shall be a "First mate, last break" style. Critically, among all of the normal assumptions we make in designing a connector, this contact has to be considered as a live part and must be protected against electric shock by double or reinforced insulation.

IP Code:

IP is a coding system defined by the IEC 60529 to indicate the degrees of protection provided by an enclosure. The aim of this is to give information regarding the accessibility of live parts against ingress of water and other foreign bodies.

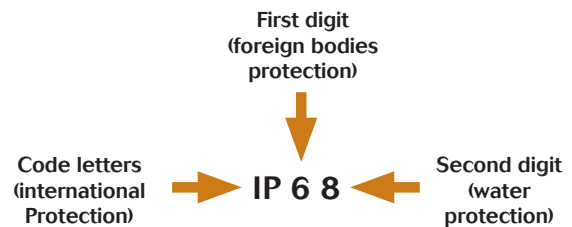

1 st digit	Degree of protection	2 nd digit	Degree of protection
0	No protection against accidental contact. No protection against solid foreign bodies.	0	No protection against water.
1	Protection against contacts with any large area by hand and against large solid foreign bodies with a diameter bigger than 50 mm.	1	Drip-proof. Protection against vertical water drips.
2	Protection against contacts with the fingers. Protection against solid foreign bodies with a diameter bigger than 12 mm.	2	Drip-proof. Protection against water drips up to a 15° angle.
3	Protection against tools, wires or similar objects with a diameter bigger than 2.5 mm. Protection against small solid bodies with a diameter bigger than 2.5 mm.	3	Spray-proof. Protection against diagonal water drips up to a 60° angle.
4	As 3 however diameter is bigger than 1 mm.	4	Splash-proof. Protection against splashed water from all directions.
5	Full protection against contacts. Protection against interior injurious dust deposits.	5	Hose-proof. Protection against water (out of a nozzle) from all directions.
6	Total protection against contacts. Protection against penetration of dust.	6	Protection against temporary flooding.
		7	Protection against temporary immersions.
		8	Protection against water pressure. Pressure to be specified by supplier.

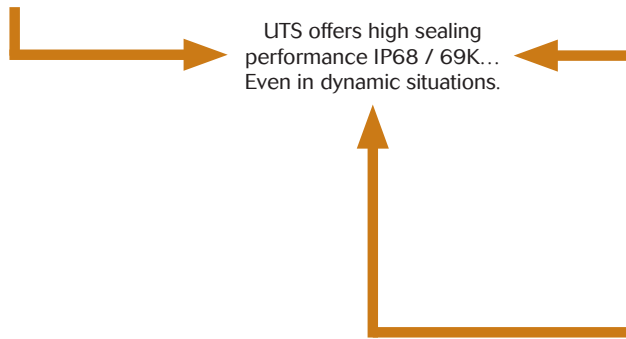

In addition to the IEC 60529 we conjointly use the DIN 40050 part 9 which are dedicated to road vehicles. The main differences are:

- **First digit:** 5 replaced by 5K, 6 by 6K. In the DIN the tested equipment is not depressurized as it is in the IEC.
- **Second digit:** 5K and 6K has been added and are equivalent respectively to 5 and 6 but with higher pressure. 9K which represents the High pressure cleaning.

9K	High pressure hose-proof. Protection against high pressure water (out of a nozzle) from all directions.
----	--



IEC 61984

Overvoltage

UTS connectors are qualified to be used on systems rated at Overvoltage category III

Per the IEC 60664-1 (formerly VDE 0110) each category is linked to the end application and where the device will be implemented:

- **Category IV** (primary overcurrent protection equipment):
Origin of the installation
- **Category III** (Any fixed installation with a permanent connection)
Fixed installation and equipment and for cases where the reliability and the availability is subject to special requirements
- **Category II** (Domestic appliances):
Energy consuming equipment to be supplied from the fixed installation
- **Category I** (Protected electronic circuit):
For connection to circuit in which measures are taken to limit transient overvoltage.

Pollution degree

Per the IEC 60664-1 (formerly VDE 0110) the environment affects the performance of the insulation. Particles can build a bridge between two metal parts. As a rule dust mixed with water can be conductive and more generally speaking metal dust is conductive. Finally, the standard defines 4 levels of pollution:

- **Degree 1** (Air conditioned dry room):
No pollution or only dry, non conductive pollution occurs. The pollution has no influence.
- **Degree 2** (Personal computer in a residential area):
Only non conductive pollution occurs except that occasionally a temporary conductivity caused by condensation is to be expected.
- **Degree 3** (Machine tools):
Conductive pollution occurs or dry non-conductive pollution occurs which becomes conductive due to condensation which is to be expected.
- **Degree 4** (Equipments on roof, locomotives):
Continuous conductivity occurs due to conductive dust, rain or other wet conditions.

Finally, the harsher the environment is, the longer clearance and creepage distances should be. Nonetheless, according the IEC 61984, enclosure rated at IP54 or higher can be dimensioned for a lower pollution degree. This applies to mated connectors disengaged for test and maintenance.

Marking

The marking should give enough details to the user to know what the main characteristics are and without going deep in technical documentation. Below examples identify the suitability of the connector:

- **Example 1:**
Marking of a connector with rated current 16A, rated voltage 400V, rated impulse voltage 6kV and pollution degree 3, 2 and 1 for use in any system, preferably unearthed or delta-earthed systems:

16A 400V 6kV 3

- **Example 2:**
Marking of a connector with rated current 16A, rated insulation voltages line-to-earth 250V, line-to-line 400V, rated impulse voltage 4kV and pollution degree 3, 2 and 1 for use in earthed systems:

16A 250V 400V 4kV 3



UTS Series

What is NEMA rating ?

• NEMA ratings vs IP ratings

Whereas IP ratings only consider protection against ingress of foreign bodies - first digit - and ingress of water (second digit), **NEMA** ratings consider these but also verify protection from external ice, corrosive materials, oil immersion, etc.

The correlation between NEMA & IP being limited only to dust and water, we can state that a NEMA type is *equivalent* to an IP rating but it is not possible to say the contrary.

Below a list of some NEMA standards:

Enclosure rating	IP20	IP22	IP55	IP64	IP65	IP66	IP67
Type 1	•						
Type 3				•			
Type 3R		•					
Type 3S				•			
Type 4						•	
Type 4X						•	
Type 6							•
Type 12			•				
Type 13					•		

- indicates compliance

Type 6 rating can be either Type 6 or Type 6P - please see below:



6	IP67	Enclosures constructed for either indoor or outdoor use to provide a degree of protection to personnel against incidental contact with the enclosed equipment, falling dirt, hose-directed water, the entry of water during occasional temporary submersion at a limited depth and damage from external ice formation.
6P	IP67	Enclosures constructed for either indoor or outdoor use to provide a degree of protection to personnel against incidental contact with the enclosed equipment, falling dirt, hose-directed water, the entry of water during prolonged submersion at a limited depth and damage from external ice formation.

UNIT'S Series



Annexes

■ Coaxial contacts - cabling notices	68
■ Glossary of terms	75
■ Coordinates for PC Tail terminations	76
■ Stand off dimensions - Drilling pattern (PCB view).....	78
■ Discrimination/Keying methods	79





Coaxial contacts

Coaxial cable - Contact monocrimp and multipiece

Cable type	Impedance	Contact type	Ø over jacket		Ø over dielectric		Inner cond size	Ø outer braid		Male contact kit for coaxial cable	Female contact kit for coaxial cable
			inch	mm	inch	mm	Ext. Ø mm	inch	mm		
RG161/U	75	Multi piece	0.09	2.29	0.057	1.45				RMDXK10D28	RCDXK10D28
RG179A/U	75		0.105	2.67	0.063	1.6	0.3	0.084	2.13 max		
RG179B/U	75		0.105	2.67	0.063	1.6	0.3	0.084	2.13 max		
RG187/U	75		0.11	2.79 max	0.06	1.52	0.3				
RG188/U	50		0.11	2.79 max	0.06	1.52	0.51	0.078	1.98 max		
RG174/U	50		0.11	2.92	0.06	1.52	0.48	0.088	2.24 max		
AMPHENOL 21-598	50		0.105	2.67	0.06	1.52	0.48				
RG196/U	50		0.08	2.03 max	0.034	0.086	0.3				
RG178A/U	50		0.075	1.91	0.034	0.86	0.3	0.054	1.37 max		
RG/188A/U	50	Mono crimp	0.110	2.79	0.06	1.52	0.51	0.078	1.98 max	RMDX60-36D28	RCDX60-36D28
KX21TVT (europe) RG178 B/U	50		0.075	1.91	0.034	0.86	0.3	0.054	1.37 max	RMDX60-34D28	RCDX60-34D28
RG178 / BU	50		0.075	1.91	0.034	0.86	0.3	0.054	1.37 max	RMDX60-50D28	RCDX60-16D28
RG174/U	50		0.115	2.92	0.06	1.52	0.48	0.088	2.24 max	RMDX60-32D28	RCDX60-32D28
RG188A/U	50		0.11	2.79	0.06	1.52	0.51	0.078	1.98 max	RMDX60-36D28	RCDX60-36D28
RG316/U	50		0.107	2.72	0.6	1.52	0.51	0.078	2.05 max	RMDX60-36D28	RCDX60-36D28
raychem 5024A3111	50		0.12	3.05	0.083	2.11	0.64	0.097	2.46	RMDX60-52D28	RCDX60-52D28
raychem 5026e1614	50		0.083	2.11	0.05	1.27	0.48	0.067	1.7	RMDX60-36D28	RCDX60-36D28
surprenant pn 8134	-		Multi piece	0.1	2.54	0.058	1.47	0.3			RMDXK10D28
PRD PN 247AS-C1123-001	-	Mono crimp	0.103	2.62	0.06	1.52	0.51	0.078	1.98	RMDX60-18D28	RCDX60-18D28
PRD PN 247AS-C1251	-		0.092	2.34	0.05	1.27	0.64	0.067	1.7	RMDX60-18D28	RCDX60-18D28
JUDD C15013010902	-		0.087	2.13	0.05	1.27	0.48	0.066	1.67	RMDX60-36D28	RCDX60-36D28
CDC PIN22939200	-		0.09	2.29	0.048	1.22	0.3	0.064	1.63	RMDX60-46D28	RCDX60-16D28
CDC PIN22939200	-		0.09	2.29	0.048	1.22	0.3	0.064	1.63	RMDX60-50D28	RCDX60-16D28
CDC PIN245670000	-		0.104	2.64	0.067	1.7	0.3	0.083	2.11	RMDX60-50D28	RCDX60-16D28
ampex	-		0.114	2.9	0.075	1.91	0.38	0.09	1.29	RMDX60-32D28	RCDX60-32D28
TI PN 920580	-		0.7	1.78	0.038	0.96	0.48	0.054	1.37	RMDX60-24D28	RCDX60-24D28
Honeywell PN 58000062	-		0.12	3.05	0.077	1.96	0.41 solid	0.096	2.44	RMDX60-26D28	RCDX60-26D28
-	-		0.104	2.64	0.067	1.7	0.3		2.11	RMDX60-50D28	RCDX60-50D28
-	-		0.09	2.29	0.048	1.22	0.3		1.63	RMDX60-50D28	RCDX60-50D28
-	-		0.114	2.9	0.075	1.91	0.38		1.29	RMDX60-32D28	RCDX60-32D28
-	-		0.07	1.78	0.038	0.96	0.48		1.37	RMDX60-24D28	RCDX60-24D28
-	-		0.12	3.05	0.077	1.96	0.41		2.44	RMDX60-26D28	RCDX60-26D28



UTS Series

Twisted cable - Contact monocrimp and multipiece

Cable type	Contact type	Inner AWG cond	Ø over jacket (single wire)		Inner cond size		Ø outer braid		Male contact kit for coaxial cable	Female contact kit for coaxial cable
			inch	mm	Stranded definition	Ext. Ø mm	inch	mm		
2#24 stranded mil w 16878 type B	Multi piece	24	0.049	1.24 max	7/.008		-	-	RMDXK10D28	RCDXK10D28
2 #24 solid mil-w-76 type LW		24	0.047	1.12 max	1/.0201		-	-	RMDXK10D28	RCDXK10D28
2 #26 stranded mil w 76 type LW or mil w16878 type b&e		26	0.043	1.09 max	7/.0063	0.16	-	-	RMDXK10D28	RCDXK10D28
2 #28 solid mil-w-81822/3		28	0.028	0.71 max			-	-	RMDXK10D28	RCDXK10D28
TWISTED PAIR 1/.201 SOLID MIL w 76 TYPE lw or MIL W 16878		26	0.044	1.12 max	1/.0201	0.511	-	-	RMDXK10D28	RCDXK10D28
twisted pair solid mil w 81822/3		28	0.028	0.71 max	1/.0126	0.32	-	-	RMDXK10D28	RCDXK10D28
#28 7/.0036 per Hitachi spec ec-711 (13-2820)		-	0.046	1.17	7/.0036	-	-	-	RMDX60-31D28 + YORX090	RCDX60-31D28 + YORX090
20218201	-	0.028	0.71	-	-	-	-	RMDX60-31D28 + YORX090	RCDX60-31D28 + YORX090	
#30 solid	-	0.025	0.64	-	-	-	-	RMDX60-15D28 + YORX090	RCDX60-15D28 + YORX090	
#26 7/.0063	26	0.028	0.71	7/.063	0.16	-	-	RMDX60-31D28 + YORX090	RCDX60-31D28 + YORX090	
#26 19/.004	26	0.049	1.24	19/.004	-	-	-	RMDX60-19D28 + YORX090	RCDX60-19D28 + YORX090	
#24 7/.008	24	0.049	1.24	7/.008	-	-	-	RMDX60-19D28 + YORX090	RCDX60-19D28 + YORX090	
#24 19/.005	24	0.057	1.45	19/.005	-	-	-	RMDX60-19D28 + YORX090	RCDX60-19D28 + YORX090	
-	26	-	1.25	-	-	-	19x0.1	RMDX60-19D28 + YORX090	RCDX60-19D28 + YORX090	
-	24	-	1.25	-	-	-	7x0.2	RMDX60-19D28 + YORX090	RCDX60-19D28 + YORX090	
-	24	-	1.45	-	-	-	19x0.13	RMDX60-19D28 + YORX090	RCDX60-19D28 + YORX090	
-	26	-	0.7	-	-	-	7x0.16	RMDX60-31D28 + YORX090	RCDX60-31D28 + YORX090	



Coaxial contacts

Twisted pair cable multipiece contact cabling

Cable reference	Contact type	Male contact	Female contact	Crimp tool	Die set	Stop bushing	Cable strip length			Inner conductor crimp		Braid crimp	
							A	B	C	g dim	t dim	g dim	t dim
2 #24 stranded mil w 16878 type B	Multi piece	RMDXK10D28	RCDXK10D28	M10S-1J	-	-				See assembly notice			
2 #24 solid mil-w-76 type LW													
2 #26 stranded mil w 76 type LW or mil w 16878 type b&e													
2 #28 solid mil-w-8 1822/3													
TWISTED PAIR 1/.201 SOLID MIL w 76 TYPE lw OR MIL W 16878													
twisted pair solid mil w 81822/3													

Female contact

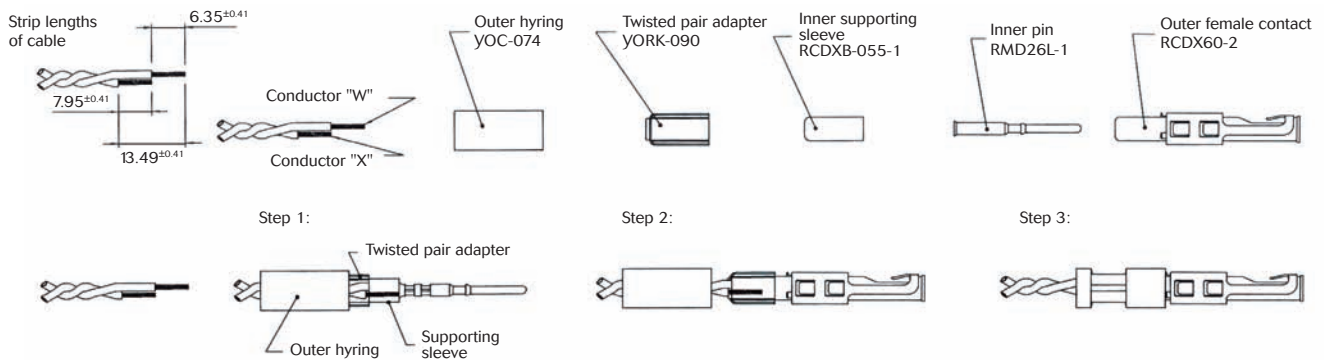

Male contact

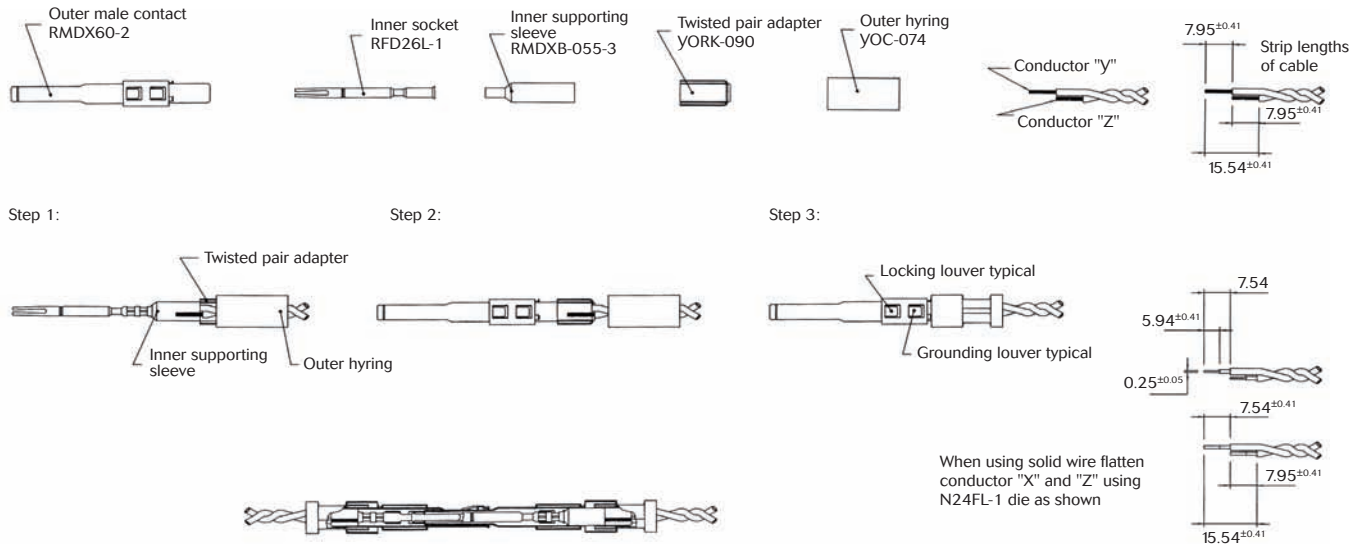

Note : all dimensions are in mm



UTS Series

Twisted pair cable monocrimp contact cabling

Cable reference	Contact type	Male contact	Female contact	Crimp tool	Die set	Stop bushing	Cable strip length			Inner conductor crimp		Braid crimp		
							A	B	C	g dim	t dim	g dim	t dim	
#28 7/.0036 per Hitachi spec ec-711 (13-2820)	Mono crimp	RMDX60-31D28 + YORX090	RCDX60-31D28 + YORX090	M10S-1J	S-80	SL-105	4.7	6.1	4.32	1.30 to 1.12	1.4 to 1.22	2.97 to 2.84	3.07 to 2.9	
20218204							3.94	6.1	3.16	1.30 to 1.17	1.4 to 1.22	2.97 to 2.84	3.07 to 2.79	
#30 solid							4.7	6.1	4.06	1.22 to 1.12	1.35 to 1.22	2.97 to 2.84	3.12 to 2.95	
#26 7/.0063							4.7	6.1	4.06	1.30 to 1.17	1.4 to 1.22	2.97 to 2.84	3.07 to 2.9	
#26 19/.004							4.7	6.1	4.06	1.22 to 1.17	1.35 to 1.22	2.84 to 2.79	3.12 to 2.97	
#24 7/.008							4.7	6.1	4.06	1.22 to 1.17	1.35 to 1.22	2.84 to 2.79	3.12 to 2.97	
#24 19/.005							4.7	6.1	4.06	1.22 to 1.17	1.35 to 1.22	2.84 to 2.79	3.12 to 2.97	
AWG26 (19x0.1)							M10SG8 crimping kit	4.7	6	4	/		/	
AWG24 (7x0.2)														
AWG24 (19x0.13)														
AWG26 (7x0.16)														
					S-80	SL-150								

- Select appropriate monocrimp coax twisted pair contact and cable combination.
- Select appropriate crimp tooling (hand tool, S-die set, stop bushing).
- Strip the twisted pair cable to the designated wire strip lengths.
- Insert the stripped cable into the contact. One cable is to be inserted into the inside diameter of hyring, and pushed forward into the inner contact. The second cable is to be inserted between the outside diameter of hyring and the inside diameter of the outer contact body.
- Crimp the contact.

Cable strip length

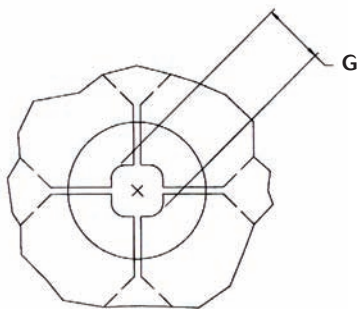
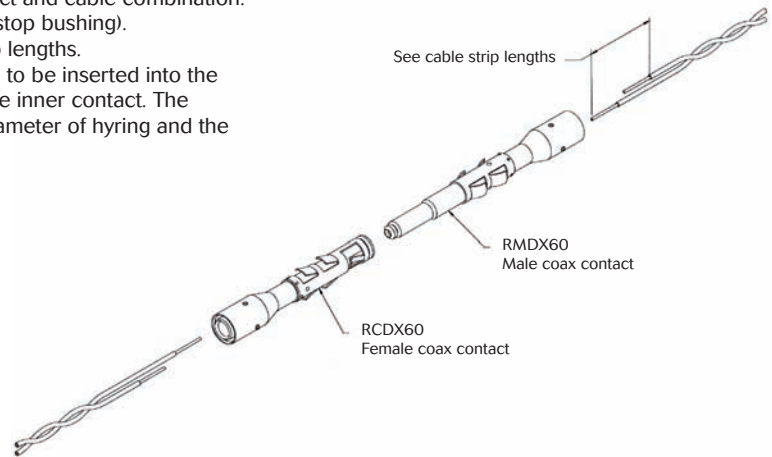
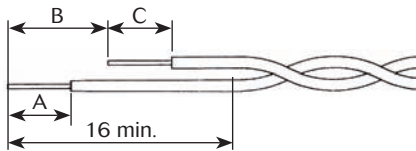

Braid crimp (G) to be measured with die set fully closed

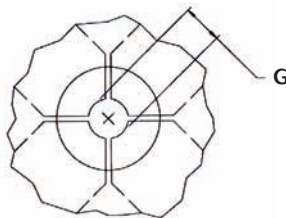

Inner conductor crimp (G) to be measured with die set fully closed

Note : all dimensions are in mm



Coaxial contacts

Multipiece male contact with coax cable

Cable reference	Outer contact	Hyiring complementary compoments	Crimp tool	Die set	Stop bushing	Inner contact	Die set	Stop bushing	Cable strip length		
									A	B	C
RG161U	Male: RMDXK10D28	YOC074	M10S-1J	S22-1	SL47-1	RFD26L1D28	S23D2	SL46D2	4.37	7.95	15.88
RG179									4.37	7.95	15.88
RG187U									4.37	7.95	15.88
RG188/U		YOC074 + RMDXB0553					4.37		7.95	15.88	
RG174/U							4.37		7.95	15.88	
RG178A/U		YOC074					7.54		9.12	17.53	
RG196U							7.54		9.12	17.53	
AMPHENOL 21-598		-					4.37		7.95	15.88	
surprenant pn 8134		-					4.37		7.95	15.88	

Multipiece kit details

RMDXK10D28 includes	Part	Description
	RMDX602D28	Body contact
	RFD26L1D28	Inner contact
	YOC-074	Outer hyiring
	RMDXB0553	Inner supporting sleeve

Cable strip length

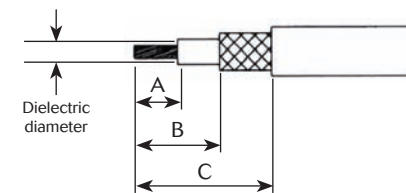

Contact assembly with dielectric diameter over 1.4mm - without inner supporting sleeve

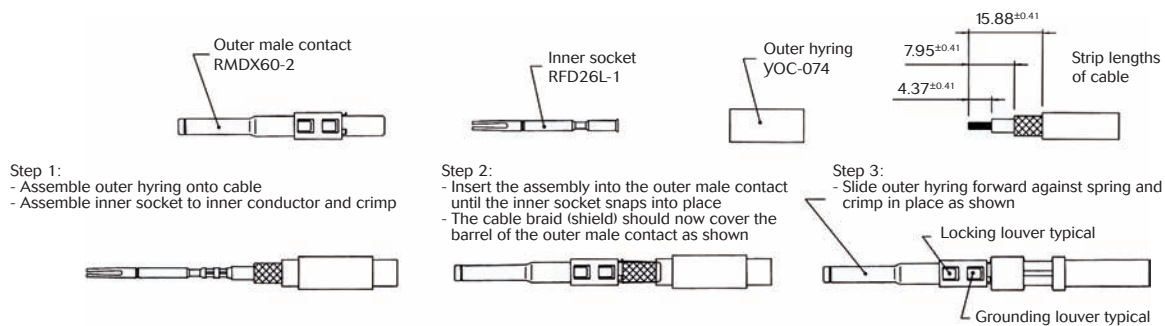

Contact assembly with dielectric diameter under 1.4mm - with inner supporting sleeve

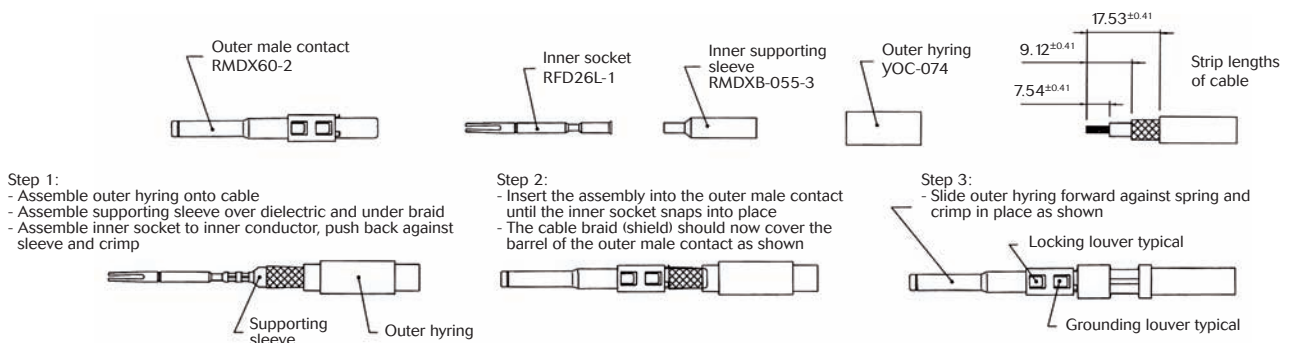

Note : all dimensions are in mm



Multipiece female contact with coax cable

Cable reference	Outer contact	Hyiring complementary compoments	Crimp tool	Die set	Stop bushing	Inner contact	Die set	Stop bushing	Cable strip length		
									A	B	C
RG161U	Female: RCDXK10D28	YOC074	M10S-1J	S22-1	SL47-1	RMD26L1D28	S23D2	SL46D2	4.37	-	11.13
RG179							4.37		11.13		
RG187U							4.37		11.13		
RG188/U							4.37		11.13		
RG174/U							4.37		11.13		
RG178A/U		YOC074 + RMDXB0553					6.35		11.13		
RG196U							6.35		11.13		
AMPHENOL 21-598		YOC074					-		4.37		11.13
surprenant pn 8134							-		4.37		11.13

Multipiece kit details

RCDXK10D28 includes	Part	Description
	RCDX602D28	Body contact
	RMD26L1D28	Inner contact
	YOC-074	Outer hyiring
	RCDXB0553	Inner supporting sleeve

Cable strip length

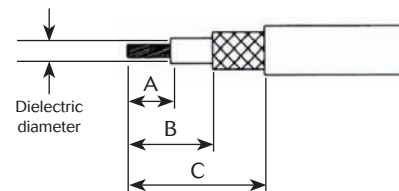

Contact assembly with dielectric diameter over 1.4mm - without inner supporting sleeve

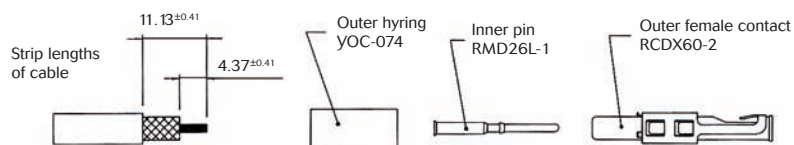

- Step 1:
 - Assemble outer hyiring onto cable
 - Assemble inner pin to inner conductor and crimp
- Step 2:
 - Insert the assembly into the outer female contact until the inner pin snaps into place
 - The cable braid (shield) should now cover the barrel of the outer female contact as shown
- Step 3:
 - Slide outer hyiring forward against spring and crimp in place as shown

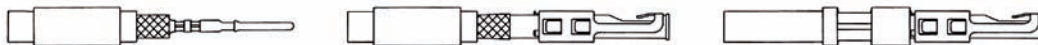

Contact assembly with dielectric diameter under 1.4mm - with inner supporting sleeve

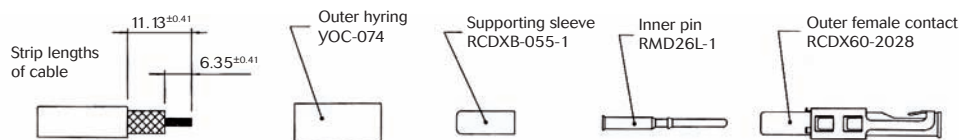

- Step 1:
 - Assemble outer hyiring onto cable
 - Assemble supporting sleeve over dielectric and under braid
 - Assemble inner pin to inner conductor, push back against sleeve and crimp
- Step 2:
 - Insert the assembly into the outer female contact until the inner pin snaps into place
 - The cable braid (shield) should now cover the barrel of the outer female contact as shown
- Step 3:
 - Slide outer hyiring forward against spring and crimp in place as shown

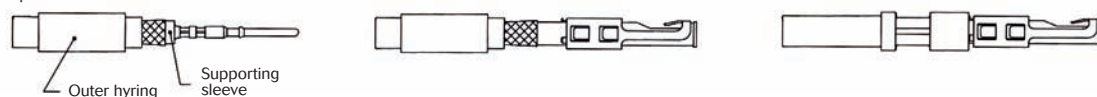

Note : all dimensions are in mm



Coaxial contacts

Coax cable with monocrimp contact cabling

Cable reference	Male contact	Female contact	Crimp tool	Die set	Stop bushing	Cable strip length			Inner conductor crimp		Braid crimp		
						A	B	C	g dim	t dim	g dim	t dim	
CDC PIN22939200	RMDX60-46D28	RCDX60-16D28	M10S-1J	S-80	SL-105	4.19	5.97	8.51	1.30/1.17	1.40/1.22	2.77/2.64	3.02/2.84	
CDC PIN22939200	RMDX60-46D28	RCDX60-16D28		S-87	SL-105	5.08	6.35	8.89	1.30/1.17	1.40/1.22	2.77/2.64	3.02/2.84	
CDC PIN245670000	RMDX60-50D28	RCDX60-16D28		S-80	SL-105	5.08	6.35	8.89	1.30/1.17	1.40/1.22	2.97/2.84	3.12/2.95	
KX21TVT (europe) RG178 B/U	RMDX60-34D28	RCDX60-34D28		S-82	SL-105	5.08	6.35	8.89	1.30/1.17	1.32/1.17	2.84/2.74	3.07/2.9	
RG178 / BU	RMDX60-50D28	RCDX60-16D28		S-87	SL-105	5.08	6.35	8.89	1.30/1.17	1.40/1.22	2.77/2.64	3.02/2.84	
ampex	RMDX60-32D28	RCDX60-32D28		S-80	SL-105	5.08	6.35	11.68	1.30/1.17	1.40/1.22	2.97/2.84	3.12/2.95	
TI PN 920580	RMDX60-24D28	RCDX60-24D28		S-82	SL-105	5.08	6.35	8.89	1.35/1.19	1.42/1.27	2.87/2.74	3.07/2.9	
RG174/U	RMDX60-32D28	RCDX60-32D28		S-80	SL-105	5.08	6.35	11.68	1.30/1.17	1.40/1.22	2.97/2.84	3.12/2.95	
Honeywell PN 58000062	RMDX60-26D28	RCDX60-26D28		S-82	SL-105	5.08	6.35	8.89	1.35/1.19	1.42/1.27	2.87/2.74	3.07/2.9	
RG188A/U	RMDX60-36D28	RCDX60-36D28		S-80	SL-105	5.08	6.35	11.68	1.30/1.17	1.40/1.22	2.97/2.84	3.12/2.95	
RG316/U	RMDX60-36D28	RCDX60-36D28		S-80	SL-105	5.08	6.35	11.68	1.30/1.17	1.40/1.22	2.97/2.84	3.12/2.95	
PRD PN 247AS-C1123-001	RMDX60-18D28	RCDX60-18D28		M10SG8 ASSY'Y TOOL DIE SET STOP BUSHING M10S-1J TOOL			5.08	6.35	8.89	1.22/1.17	1.35/1.22	2.92/2.79	3.12/2.97
PRD PN 247AS-C1251	RMDX60-18D28	RCDX60-18D28					5.08	6.35	8.89	1.22/1.17	1.35/1.22	2.92/2.79	3.12/2.97
raychem 5024A3111	RMDX60-52D28	RCDX60-52D28		S-88	SL-105	5.08	6.35	11.68	1.37/1.27	1.45/1.32	2.92/2.79		
raychem 5026e1614	RMDX60-36D28	RCDX60-36D28		M10SG8 ASSY'Y TOOL DIE SET STOP BUSHING M10S-1J TOOL			5.08	6.35	8.89	1.22/1.17	1.35/1.22	2.92/2.79	3.12/2.97
JUDD C15013010902	RMDX60-36D28	RCDX60-36D28					5.08	6.35	8.89	1.22/1.17	1.35/1.22	2.92/2.79	3.12/2.97
inner cond. #30, braid diam 2.64	RMDX60-50D28	RCDX60-50D28		S-80	SL-105	5.1	6.35	8.9	-	-	-	-	
inner cond. #30, braid diam 2.29	RMDX60-50D28	RCDX60-50D28		S-87	SL-105	4.2	6.35	8.5	-	-	-	-	
inner cond. #28, braid diam 2.9	RMDX60-32D28	RCDX60-32D28		S-80	SL-105	5.1	6.35	11.7	-	-	-	-	
inner cond. #26, braid diam 1.78	RMDX60-24D28	RCDX60-24D28		S-82	SL-105	5.1	6.35	8.9	-	-	-	-	
inner cond. #26, braid diam 3.05	RMDX60-26D28	RCDX60-26D28	S-82	SL-105	5.1	6.35	8.9	-	-	-	-		

- Select appropriate cable and contact combination.
- Select appropriate crimp tooling (hand tool, S-die set, stop bushing).
- Strip coax cable to the designated wire strip lengths.
- Insert the stripped coax into the rear of the contact.
- Crimp the contact.

Cable strip length

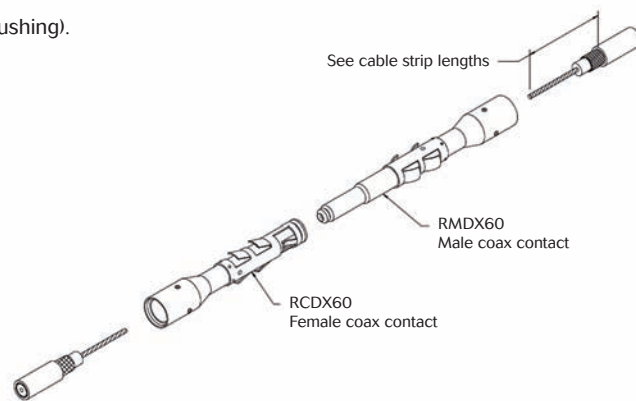
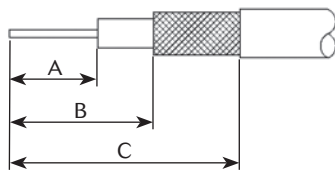



Glossary of terms

- **Clearance**

Per the IEC 60664-1 it is the shortest distance between two conductive parts even over the air.

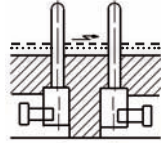

- **Creepage distance**

Per the IEC 60664-1 it represents the shortest distance along the surface of the insulating material between two conductive parts.

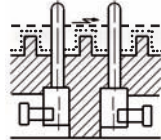

--- Air gap
..... Creepage distance

- **Working voltage**

Per the IEC 60664-1 it is the highest r.m.s. value of A.C. or D.C. voltage across any particular insulation which can occur when the equipment is supplied at rated voltage.

- **Rated impulse voltage**

Impulse withstands voltage value assigned by the manufacturer to the equipment or to a part of it characterizing the specified withstand capability of its insulation against transient overvoltage.

- **Working current**

It is the maximum continuous and not interrupted current able to be carried by all contacts without exceeding the maximum temperature of the insulating material.

- **Transient voltage**

Extract from the IEC 60664-1: Short duration overvoltage of a few millisecond or less, oscillatory or non-oscillatory, usually highly damped.

- **CTI (Comparative Tracking Index)**

The CTI value is commonly used to characterize the electrical breakdown properties of an insulating material. It allows users to know the tendency to create creepage paths. This value represents the maximum voltage after 50 drops of ammonium chloride solution without any breakdown.

- **RTI (Relative temperature Index):**

Extract from ULs website:

“Maximum service temperature for a material, where a class of critical property will not be unacceptably compromised through chemical thermal degradation, over the reasonable life of an electrical product, relative to a reference material having a confirmed, acceptable corresponding performance defined RTI.

- **RTI Elec:** Electrical RTI, associated with critical electrical insulating properties.

- **RTI Mech Imp:** Mechanical Impact RTI, associated with critical impact resistance, resilience and flexibility properties.

- **RTI Mech Str:** Mechanical Strength (Mechanical without Impact) RTI, associated with critical mechanical strength where impact resistance, resilience and flexibility are not essential”



Drilling patterns (terminations viewed from male rear face, soldering side)

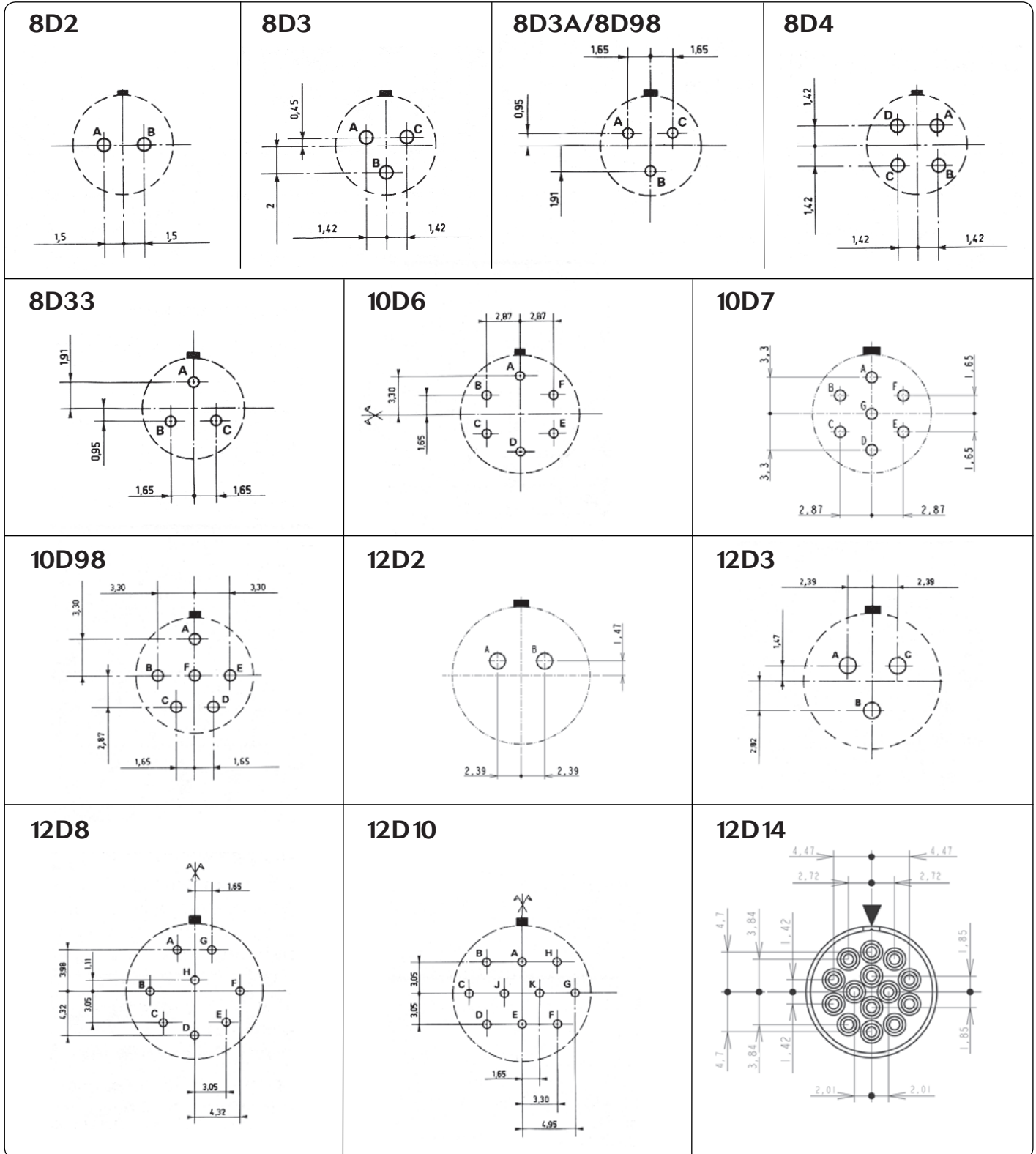



UTS Series

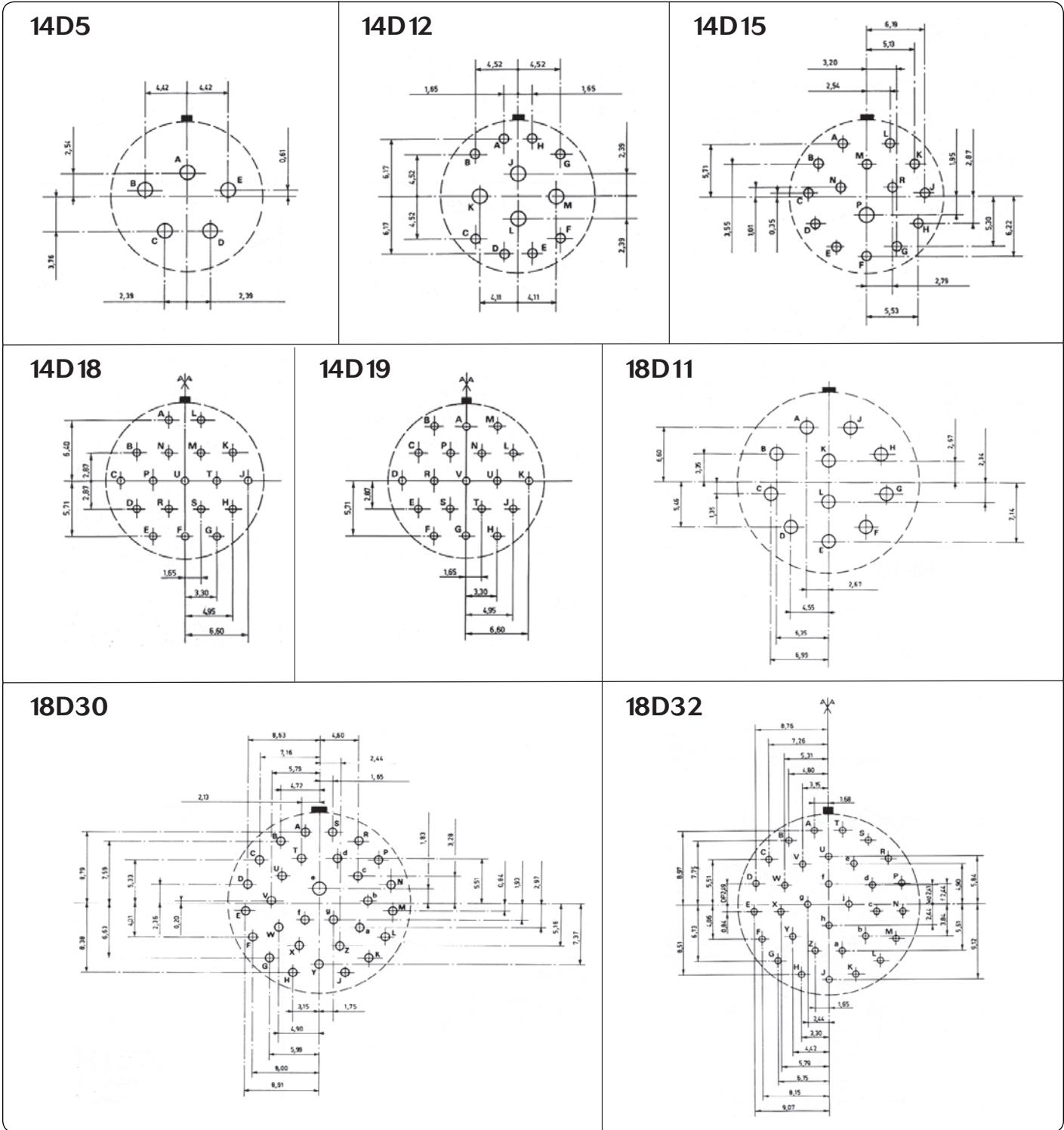



Stand off dimensions - Drilling pattern (PCB view)

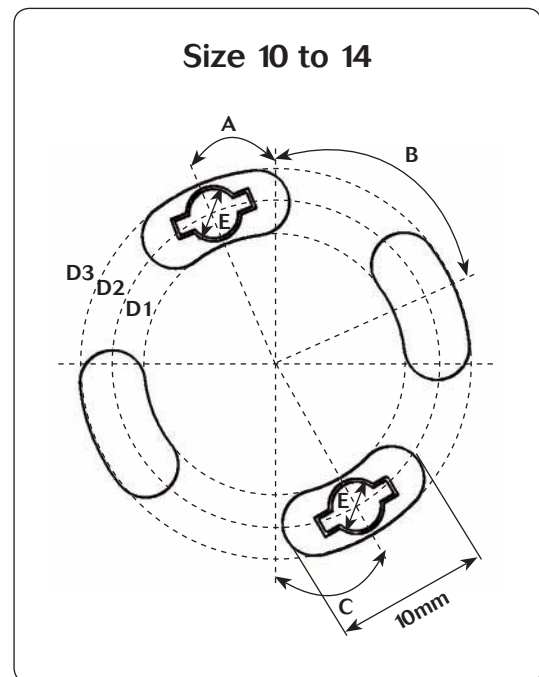
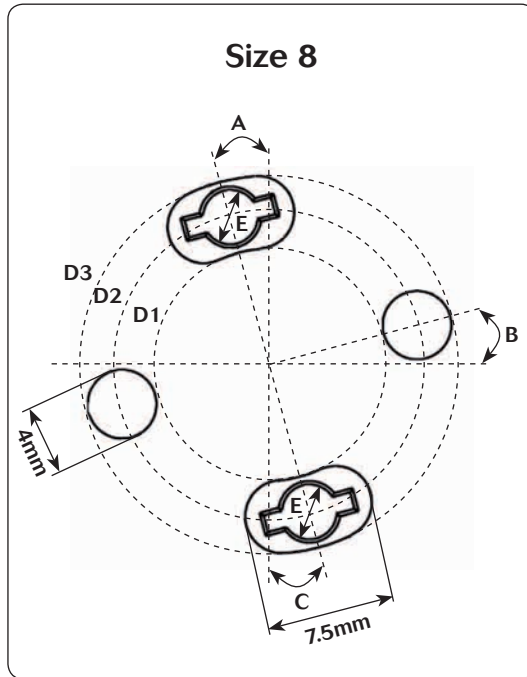

Shell size	Angle A	Angle B	Angle C	Ø Internal diameter D1	Diameter D2	Ø External diameter D3	Ø E
8	15°	15°	15°	13.5	17.7	22	3.1
10	22°	68°	30°	17	21.25	25.5	
12				22	26.25	30.5	
14			24		32.5		

Note : all dimensions are in mm



UTS Series

Discrimination/Keying methods

In applications where similar connectors are used next to each other, mismatching can be a reason for disturbances, system failure or even danger to operating personnel.

To eliminate mismatching, all TRIM TRIO® connectors can be equipped with discrimination keys, which offer unlimited possibilities for an error avoiding interconnection system.

The other way around is to rotate the insert into the shell.

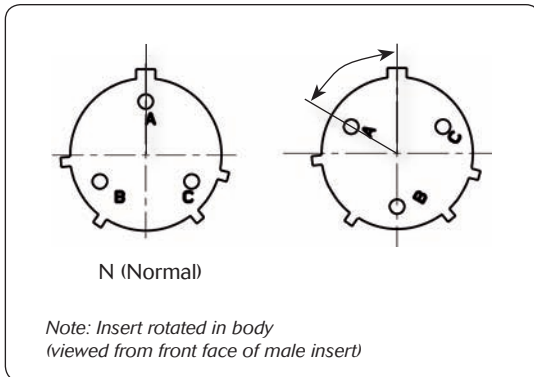

Connectors with rotated inserts can be ordered by adding the suffix W, X, Y or Z to the standard part number.

Shell size	Layout	Discrimination keys degrees			
		W	X	y	Z
8	8E2	58°	122°		
	8E3 8E3A	60°	210°		
	8E4	45°			
	8E33	90°			
10	102W2 103				
	104 106	45°			
	10E6 10E7	90°			
	10E98	90°	180°	240°	270°
12	12E2				
	12E3			180°	
	124				
	128	26°			
	12E8	90°	112°	203°	292°
	12 10 12E10	60°	155°	270°	295°
	12E14	45°			
14	14E5	40°	92°	184°	273°
	142G1 147				
	14 12	60°			
	14E12	43°	90°		
	14E15	17°	110°	155°	234°
	14E18	15°	90°	180°	270°
	14 19	30°	165°	315°	
	14E19	30°	165°	315°	
18	18E11	62°	119°	241°	340°
	1823		158°		270°
	18E30	180°	193°	285°	350°
	1832 18E32	85°	138°	222°	265°

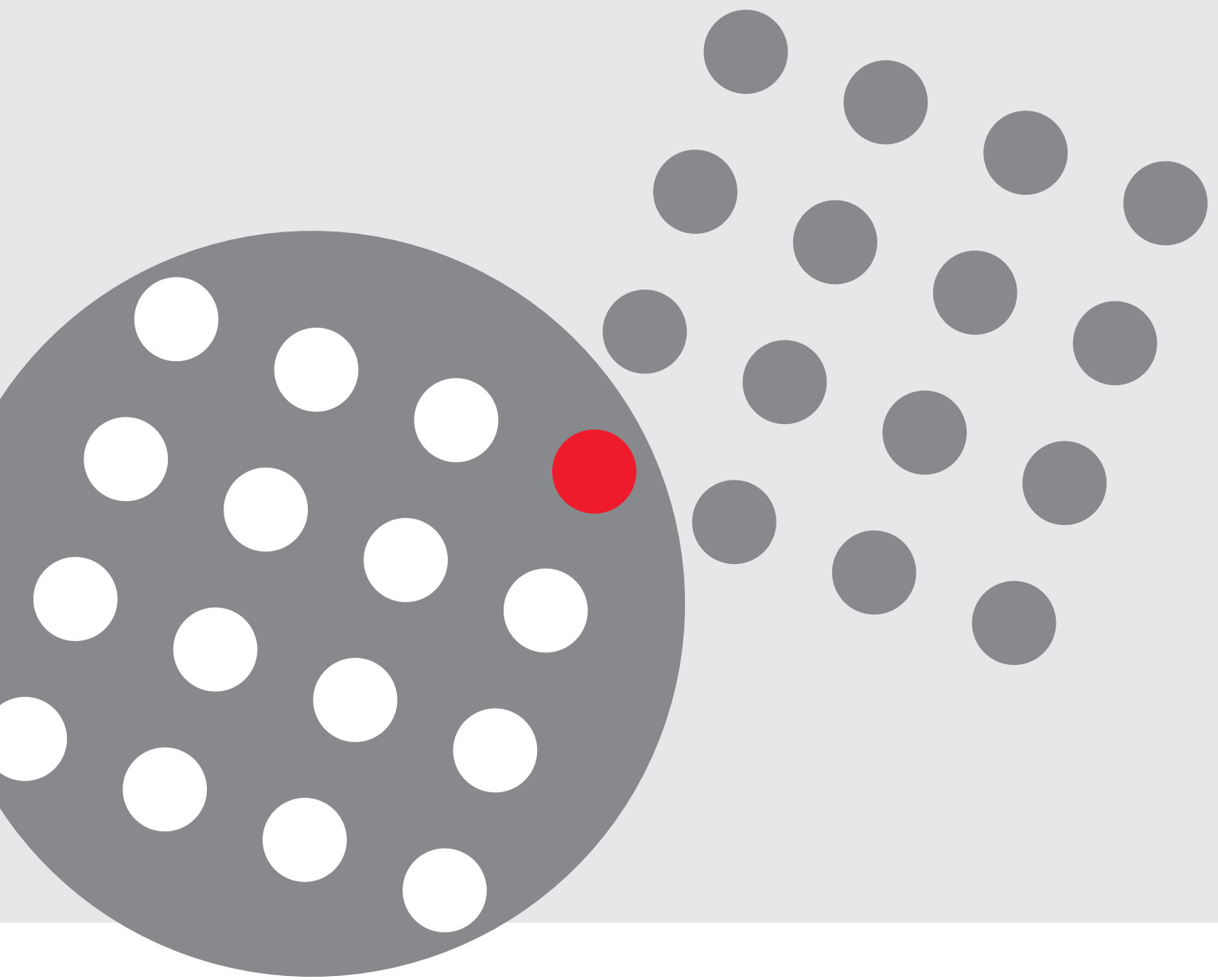

www.souriau.com
www.souriau-industrial.com
contactindustry@souriau.com

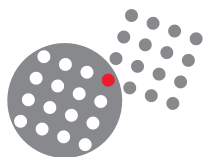

SOURIAU
Connection Technology