

# NBC-MSD/ 2,0-93K/R4AC SCO - Network cable



1411515

<https://www.phoenixcontact.com/us/products/1411515>

Please be informed that the data shown in this PDF document is generated from our online catalog. Please find the complete data in the user documentation. Our general terms of use for downloads are valid.



Network cable, Sercos CAT5 (100 Mbps), 4-position, PVC/PVC, signal red RAL 3020, shielded, Plug straight M12 SPEEDCON, coding: D / IP67, on Plug straight RJ45 / IP20, cable length: 2 m

## Commercial data

Item number	1411515
Packing unit	1 pc
Minimum order quantity	25 pc
Product key	BF1CJO
GTIN	4046356933735
Weight per piece (including packing)	167.6 g
Weight per piece (excluding packing)	167.6 g
Country of origin	PL

1411515

<https://www.phoenixcontact.com/us/products/1411515>

## Technical data

### Product properties

Product type	Data cable preassembled
Application	Standard
Sensor type	Sercos
Number of positions	4
Shielded	yes
Coding	D

### Interfaces

Bus system	Sercos III
Signal type/category	Sercos CAT5 (IEC 11801), 100 Mbps

### Signaling

Status display	No
Status display present	No

### Electrical properties

Nominal voltage $U_N$	48 V AC
	60 V DC
Nominal current $I_N$	1 A
Transmission medium	Copper
Transmission characteristics (category)	CAT5 (IEC 11801:2002)

### Connector

#### Connection 1

Type	Plug straight M12 SPEEDCON / IP67
Number of positions	4
Locking type	SPEEDCON
Coding type	D (Data)
Handle color	black
Material	CuSn (Contact)
	Ni/Au (Contact surface)
	PA (Contact carriers)
	TPU, hardly inflammable, self-extinguishing (Grip)
	Zinc die-cast, nickel-plated (Screw connection)
Insertion/withdrawal cycles	$\geq 100$
Insulation resistance	$\geq 100 \text{ M}\Omega$
Tightening torque	0.4 Nm
Degree of protection	IP67
Ambient temperature (operation)	-25 °C ... 90 °C

#### Connection 2

# NBC-MSD/ 2,0-93K/R4AC SCO - Network cable



1411515

<https://www.phoenixcontact.com/us/products/1411515>

Type	Plug straight RJ45 / IP20
Number of positions	4 (8)
Handle color	black
Material	CuSn (Contact) Ni/Au (Contact surface) PA (Contact carriers) PA (Housing)
Insertion/withdrawal cycles	≥ 750
Degree of protection	IP20
Ambient temperature (operation)	-25 °C ... 80 °C

## Cable/line

Cable length	2 m
--------------	-----

### Sercos III [93K]

Dimensional drawing	
Cable weight	68 kg/km
UL AWM Style	21694 (60 °C / 600 V)
Number of positions	4
Shielded	yes
Cable type	Sercos III [93K]
Conductor structure	1x4xAWG22/7, SF/TQ
Signal runtime	5.3 ns/m
Conductor structure signal line	7x 0.25 mm
AWG signal line	22
Conductor cross section	4x 0.34 mm <sup>2</sup>
Wire diameter incl. insulation	approx. 1.55 mm
External cable diameter	6.50 mm ±0.2 mm
Outer sheath, material	PVC
External sheath, color	signal red RAL 3020
Conductor material	Tin-plated Cu litz wires
Material wire insulation	PE
Single wire, color	white, yellow, blue, orange
Thickness, outer sheath	approx. 0.90 mm
Type of pair shielding	Aluminum-lined polyester foil
Overall twist	Star quad
Max. conductor resistance	≤ 120 Ω/km

1411515

<https://www.phoenixcontact.com/us/products/1411515>

Insulation resistance	$\geq 0.5 \text{ G}\Omega \cdot \text{km}$
Coupling resistance	$\leq 20.00 \text{ m}\Omega/\text{m}$ (at 10 Hz)
Wave impedance	$100 \Omega \pm 15 \Omega$ (at 100 MHz)
Nominal voltage, cable	600 V
Test voltage Core/Core	2000 V (50 Hz, 1 min.)
Test voltage Core/Shield	2000.00 V (50 Hz, 1 min.)
Minimum bending radius, fixed installation	3 x D
Minimum bending radius, flexible installation	7 x D
Smallest bending radius, fixed installation	20 mm
Smallest bending radius, movable installation	46 mm
Flame resistance	according to UL 1685 (CSA FT 4)
Resistance to oil	Resistant to oil to a limited extent
Other resistance	UV resistant (According to UL 1581, Section 1200)
Ambient temperature (operation)	-40 °C ... 70 °C (cable, fixed installation) -40 °C ... 70 °C (Cable, flexible installation)
Ambient temperature (installation)	-20 °C ... 60 °C

### Environmental and real-life conditions

#### Ambient conditions

Degree of protection	IP65 (M12 connector)
	IP67 (M12 connector)
	IP20 (RJ45 connector)
Ambient temperature (operation)	-25 °C ... 90 °C (M12 connector)
	-25 °C ... 80 °C (RJ45 connector)

### Standards and regulations

#### M12

Standard designation	M12 connector
Standards/specifications	IEC 61076-2-101

1411515

<https://www.phoenixcontact.com/us/products/1411515>

## Drawings

### Schematic diagram

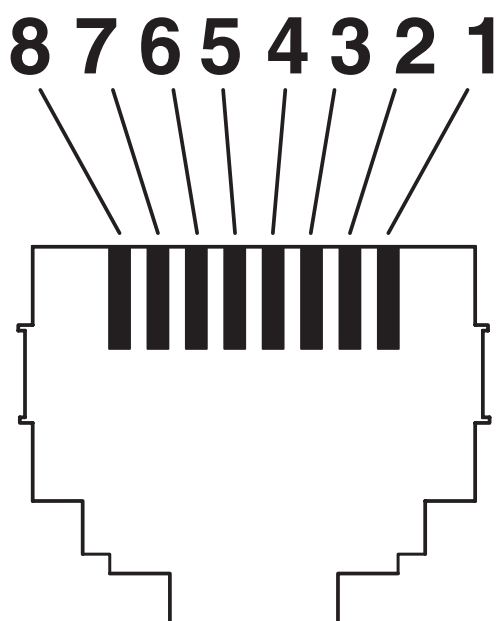

Connector pin assignment plug RJ45

# NBC-MSD/ 2,0-93K/R4AC SCO - Network cable



1411515

<https://www.phoenixcontact.com/us/products/1411515>

Dimensional drawing

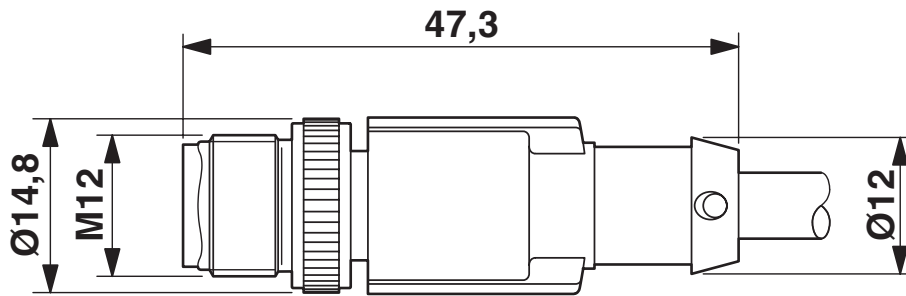

Plug, M12 x 1, straight, shielded

Circuit diagram

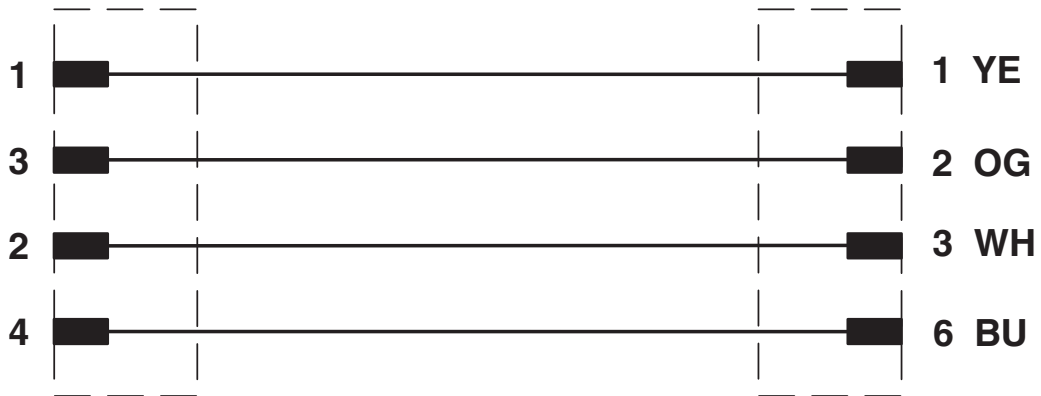

# NBC-MSD/ 2,0-93K/R4AC SCO - Network cable

1411515

<https://www.phoenixcontact.com/us/products/1411515>

Dimensional drawing

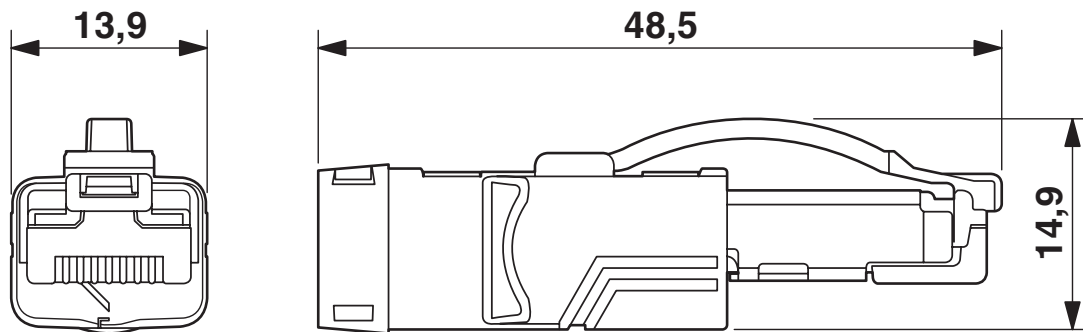

RJ45 connector, IP20

Schematic diagram

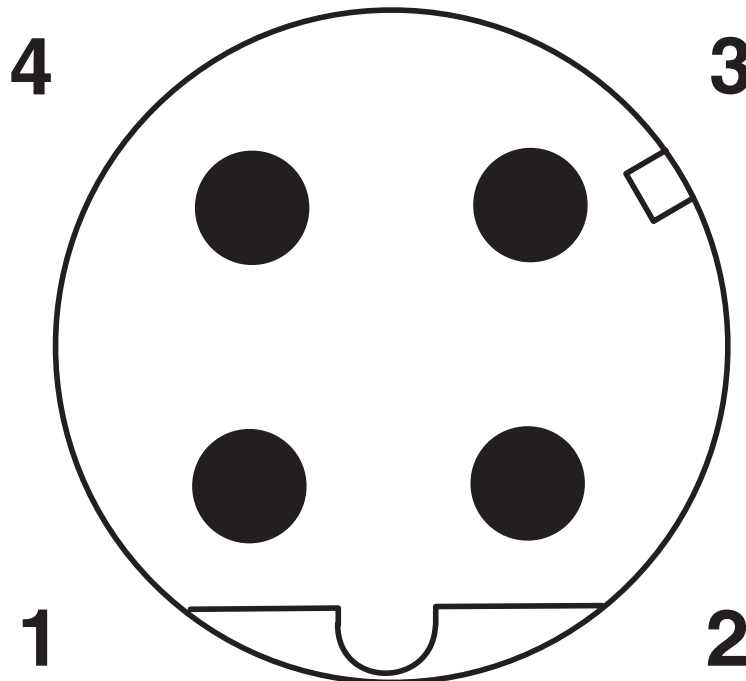

Pin assignment M12 male connector, 4-pos., D-coded, male side

# NBC-MSD/ 2,0-93K/R4AC SCO - Network cable



1411515

<https://www.phoenixcontact.com/us/products/1411515>

## Approvals

To download certificates, visit the product detail page: <https://www.phoenixcontact.com/us/products/1411515>

 <b>cULus Listed</b> Approval ID: NBC-M12MSD Series				
	Nominal voltage $U_N$	Nominal current $I_N$	Cross section AWG	Cross section $\text{mm}^2$
	60 V	0.5 A	-	-



# NBC-MSD/ 2,0-93K/R4AC SCO - Network cable



1411515

<https://www.phoenixcontact.com/us/products/1411515>

## Classifications

### ECLASS

ECLASS-11.0	27060307
ECLASS-12.0	27060307
ECLASS-13.0	27060307

### ETIM

ETIM 9.0	EC001855
----------	----------

### UNSPSC

UNSPSC 21.0	26121600
-------------	----------

1411515

<https://www.phoenixcontact.com/us/products/1411515>

## Environmental product compliance

### EU RoHS

Fulfills EU RoHS substance requirements	Yes, No exemptions
---	--------------------

### China RoHS

Environment friendly use period (EFUP)	EFUP-E
	No hazardous substances above the limits

### EU REACH SVHC

REACH candidate substance (CAS No.)	No substance above 0.1 wt%
-------------------------------------	----------------------------

1411515

<https://www.phoenixcontact.com/us/products/1411515>

## Accessories

### PROT-M12 FS-PA-CHAIN - Sealing cap

1430873

<https://www.phoenixcontact.com/us/products/1430873>

M12 sealing cap made of plastic with fixing band, for sensor cables, for free M12 plugs



---

### SAC-M12-EXCLIP-M - Locking clip

1558988

<https://www.phoenixcontact.com/us/products/1558988>

Locking clip for the pin side of sensor/actuator cables with M12 connector and M12 connectors for assembly, for knurl diameter: 15 mm or for Allen key with a wrench size of 14 mm, prevents the disconnection of plug-in connections without tools



# NBC-MSD/ 2,0-93K/R4AC SCO - Network cable



1411515

<https://www.phoenixcontact.com/us/products/1411515>

## TSD 04 SAC - Torque screwdriver

1208429

<https://www.phoenixcontact.com/us/products/1208429>



Torque screwdriver, with preset torque of 0.4 Nm and 4 mm hexagonal drive for M12 connectors

---

## TSD-M 1,2NM - Torque screwdriver

1212224

<https://www.phoenixcontact.com/us/products/1212224>



Torque screw driver, accuracy as per EN ISO 6789 standard, adjustable from 0.3 - 1.2 Nm

# NBC-MSD/ 2,0-93K/R4AC SCO - Network cable



1411515

<https://www.phoenixcontact.com/us/products/1411515>

## TSD-M SAC-BIT ADAPTER - Adapter insert

1212600

<https://www.phoenixcontact.com/us/products/1212600>



Adapter bit for TSD-M...torque tools, E6.3-1/4" drive with 4 mm hexagon to accommodate SAC bits

---

## SAC BIT M12-D15 - Tool

1208432

<https://www.phoenixcontact.com/us/products/1208432>



Nut for assembling sensor/actuator cables with M12 connector and M12 connectors for assembly, with a knurl diameter of 15 mm, for 4 mm hexagonal drive

---

Phoenix Contact 2024 © - all rights reserved  
<https://www.phoenixcontact.com>

Phoenix Contact USA  
586 Fulling Mill Road  
Middletown, PA 17057, United States  
(+717) 944-1300  
[info@phoenixcon.com](mailto:info@phoenixcon.com)