

# Voltage Variable Attenuator

## EVA-1500+

50Ω 100 to 1500 MHz



CASE STYLE: HE1354

### The Big Deal

- Broad band, 100 to 1500 MHz
- IP2 +85 dBm typ., IP3 +49 dBm typ.
- Well matched in/out ports, return loss 18.5 dB typ.
- Minimal phase deviation over attenuation range
- Drop-in, no external matching circuits required

### Product Overview

The EVA-1500+ is a Voltage Variable 50Ω matched Attenuator built into a shielded (0.394" x 0.394" x 0.15") case. The model utilizes well matched PIN diodes, carefully biased in order to enable very low insertion loss with very low supply and control current consumption.

### Key Features

Feature	Advantages
Insertion loss of 1.5 dB up to 500MHz	Low insertion loss means very less power dissipation, so SNR will be maintained without much degradation.
Low power consumption: <ul style="list-style-type: none"><li>• Supply voltage +3 V</li><li>• Supply current 0.5 mA max.</li><li>• Control voltage 0 - 5 V</li><li>• Control current 7 mA max.</li></ul>	Needs very little current for adjusting the attenuation range so that a wide range of drivers can be chosen to control attenuation.
IP3 +49 dBm typ. IP2 +85 dBm typ.	Low distortion enabling improved system performance.
Minimal phase deviation over attenuation range	Can provide low signal distortion over attenuation range.

#### Notes

- A. Performance and quality attributes and conditions not expressly stated in this specification document are intended to be excluded and do not form a part of this specification document.  
B. Electrical specifications and performance data contained in this specification document are based on Mini-Circuit's applicable established test performance criteria and measurement instructions.  
C. The parts covered by this specification document are subject to Mini-Circuits standard limited warranty and terms and conditions (collectively, "Standard Terms"); Purchasers of this part are entitled to the rights and benefits contained therein. For a full statement of the Standard Terms and the exclusive rights and remedies thereunder, please visit Mini-Circuits' website at [www.minicircuits.com/MCLStore/terms.jsp](http://www.minicircuits.com/MCLStore/terms.jsp)



# Surface Mount Voltage Variable Attenuator

## EVA-1500+

50Ω 100 to 1500 MHz

### Maximum Ratings

Operating Temperature	-45°C to 85°C
Storage Temperature	-55°C to 100°C
Absolute Max. Supply Voltage(V+)	6V
Absolute Max. Control Voltage(Vctrl)	10V
Absolute Max. RF Input Level	+20dBm

Permanent damage may occur if any of these limits are exceeded.

### Pin Connections

RF IN	1
RF OUT	6
V CONTROL	3
V+	4
GROUND	2,5

### Outline Drawing

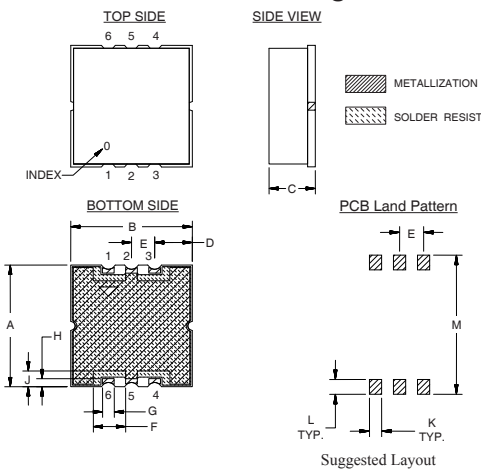

### Outline Dimensions (inch/mm)

A	B	C	D	E	F	G	H	J	K	L	M	wt. grams
.394	.394	.150	.122	.075	.098	.038	.026	.051	.038	.046	.434	0.7
10.01	10.01	3.81	3.10	1.90	2.49	0.97	0.66	1.29	0.97	1.17	11.02	

### Demo Board MCL P/N: TB-474+ Suggested PCB Layout (PL-285)

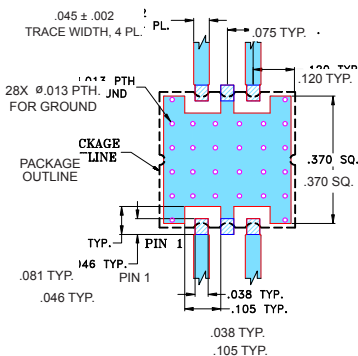

- NOTES:
- TRACE WIDTH IS SHOWN FOR FR4 WITH DIELECTRIC THICKNESS .025 ± .002". COPPER: 1/2 OZ. EACH SIDE. FOR OTHER MATERIALS TRACE WIDTH MAY NEED TO BE MODIFIED.
  - BOTTOM SIDE OF THE PCB IS CONTINUOUS GROUND PLANE.
- DENOTES PCB COPPER LAYOUT WITH SMOBC (SOLDER MASK OVER BARE COPPER)  
■ DENOTES COPPER LAND PATTERN FREE OF SOLDER MASK

#### Notes

- Performance and quality attributes and conditions not expressly stated in this specification document are intended to be excluded and do not form a part of this specification document.
- Electrical specifications and performance data contained in this specification document are based on Mini-Circuit's applicable established test performance criteria and measurement instructions.
- The parts covered by this specification document are subject to Mini-Circuits standard limited warranty and terms and conditions (collectively, "Standard Terms"); Purchasers of this part are entitled to the rights and benefits contained therein. For a full statement of the Standard Terms and the exclusive rights and remedies thereunder, please visit Mini-Circuits' website at [www.minicircuits.com/MCLStore/terms.jsp](http://www.minicircuits.com/MCLStore/terms.jsp)

### Features

- Frequency range, 100-1500 MHz
- Low current consumption
- Low insertion loss
- IP2 +85 dBm typ.
- IP3 +49 dBm typ.
- Minimal phase deviation over attenuation range
- No external bias and RF matching network required
- Shielded case
- Aqueous washable

### Applications

- Power level control
- Feed forward amplifier
- Test equipment
- VHF

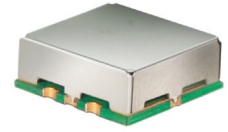

CASE STYLE: HE1354

### +RoHS Compliant

The +Suffix identifies RoHS Compliance. See our web site for RoHS Compliance methodologies and qualifications

### Electrical Specifications (T<sub>AMB</sub> = 25°C)

FREQ. (MHz)	MIN. INSERTION LOSS, dB (+5V)		MAX. ATTEN. dB (0V)		INPUT POWER (dBm)	CONTROL Voltage Current (V) (mA)		IP3* (dBm)	IP2* (dBm)	RETURN LOSS (dB)	POWER SUPPLY Voltage Current (V) (mA)	
	Min.	Max.	Typ.	Min.		Max.	Typ.				Max.	Typ.
100 - 500	1.5	2.5	35	25	+20	0 - 5	7	47	80	17	+3	0.5
500 - 1000	1.7	3.0	30	20	+20	0 - 5	7	50	85	20	+3	0.5
1000 - 1500	2.0	3.5	25	17	+20	0 - 5	7	50	85	20	+3	0.5

#### Notes:

- Rise/Fall time: 13 μSec / 15 μSec Typ.  
Switching Time, turn on/off: 15 μSec / 25 μSec Typ.  
\* Typical IP2 & IP3 at Vc=5V

### Equivalent Schematic

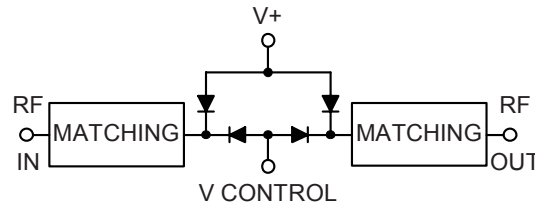

### EVA-1500+ TYPICAL ATTENUATION AT 1000 MHz

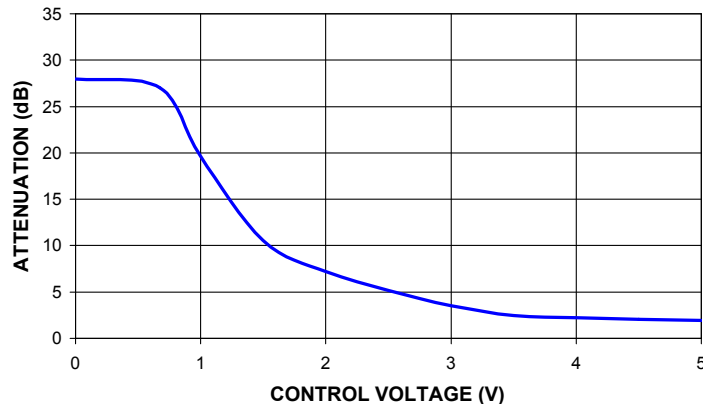

**EVA-1500+  
ATTENUATION Vs. FREQUENCY  
OVER CONTROL VOLTAGES**

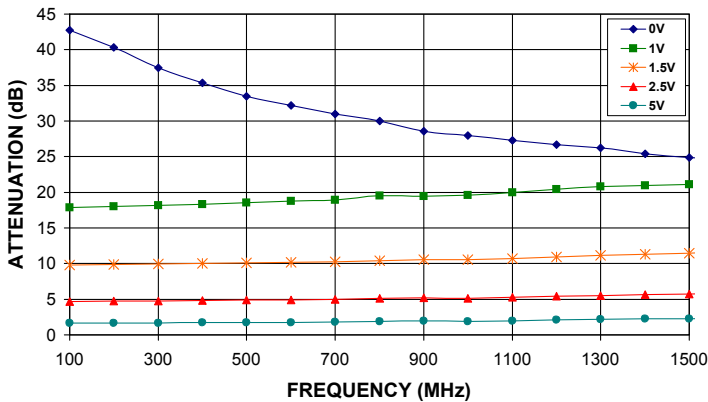

**EVA-1500+  
ATTENUATION Vs. INPUT POWER  
OVER CONTROL VOLTAGES AT 1000 MHz**

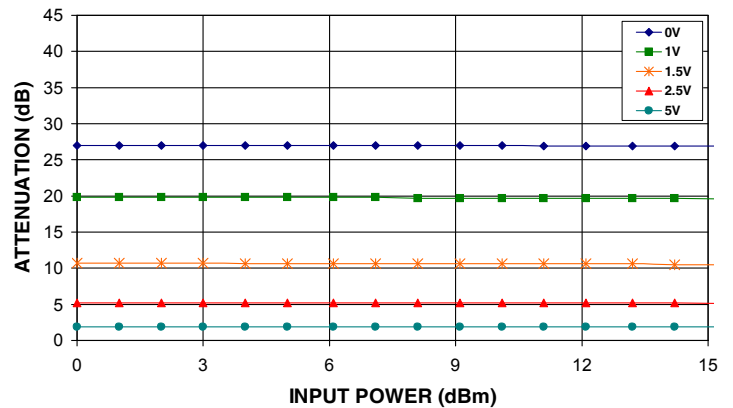

**EVA-1500+  
INPUT RETURN LOSS Vs. FREQUENCY  
OVER CONTROL VOLTAGES**

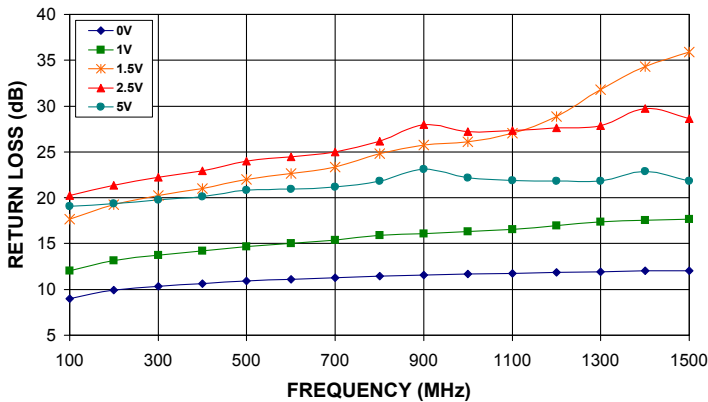

**EVA-1500+  
OUTPUT RETURN LOSS Vs. FREQUENCY  
OVER CONTROL VOLTAGES**

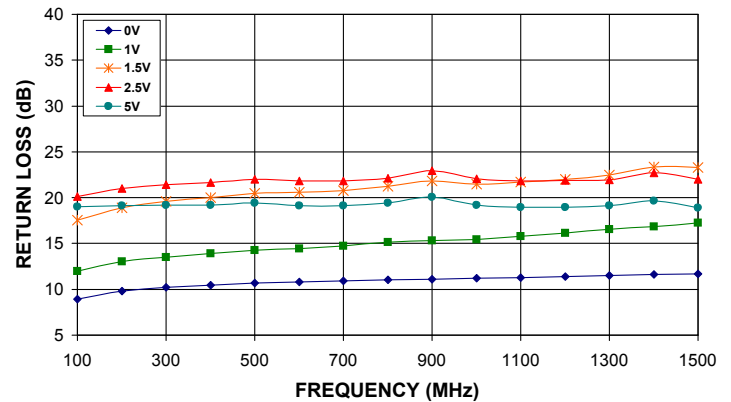

**EVA-1500+  
IP2 & IP3 Vs. FREQUENCY  
@ Vc=5V**

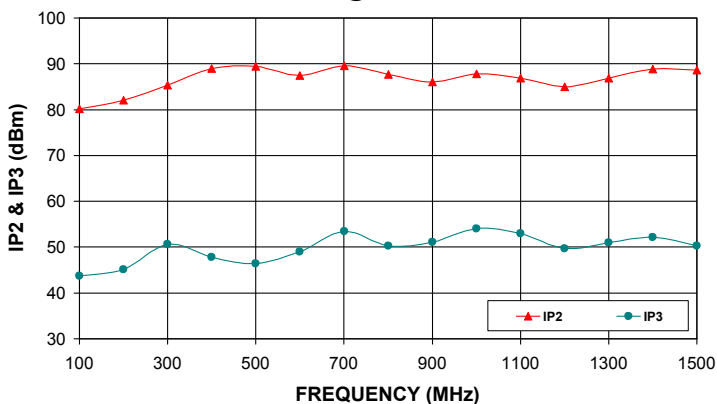

**EVA-1500+  
PHASE SHIFT Vs. FREQUENCY  
OVER CONTROL VOLTAGES**

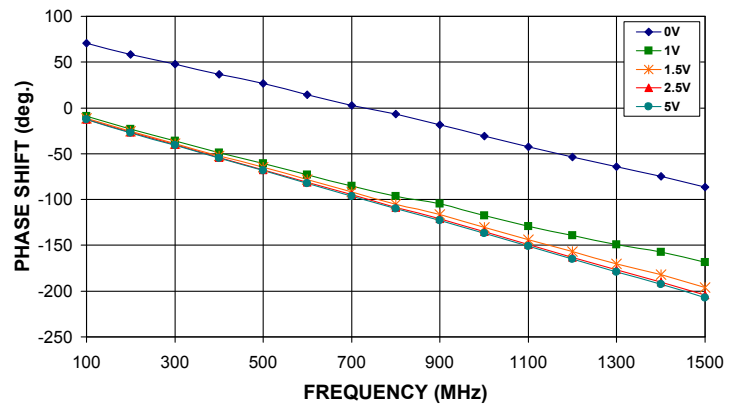

**Notes**

- A. Performance and quality attributes and conditions not expressly stated in this specification document are intended to be excluded and do not form a part of this specification document.
- B. Electrical specifications and performance data contained in this specification document are based on Mini-Circuit's applicable established test performance criteria and measurement instructions.
- C. The parts covered by this specification document are subject to Mini-Circuits standard limited warranty and terms and conditions (collectively, "Standard Terms"). Purchasers of this part are entitled to the rights and benefits contained therein. For a full statement of the Standard Terms and the exclusive rights and remedies thereunder, please visit Mini-Circuits' website at [www.minicircuits.com/MCLStore/terms.jsp](http://www.minicircuits.com/MCLStore/terms.jsp)



# Voltage Variable Attenuator

EVA-1500+

## Typical Performance Data

V CONTROL (V)	ATTENUATION @ 1000 MHz (dB) @V+=3V
0.0	27.98
0.7	27.05
1.0	19.62
1.5	10.53
2.0	7.23
2.5	5.15
3.0	3.51
3.5	2.48
4.0	2.23
4.5	2.04
5.0	1.91

FREQ. (MHz)	ATTENUATION Vs. V CONTROL @ V+=3V				
	(dB)				
	@V Control=0V	@V Control=1V	@V Control=1.5V	@V Control=2.5V	@V Control=5V
100	42.71	17.88	9.80	4.69	1.63
200	40.33	18.01	9.87	4.74	1.65
300	37.44	18.17	9.94	4.78	1.68
400	35.34	18.31	9.99	4.82	1.70
500	33.48	18.53	10.09	4.89	1.75
600	32.22	18.74	10.16	4.93	1.77
700	30.95	18.94	10.23	4.96	1.79
800	29.99	19.49	10.43	5.11	1.91
900	28.60	19.44	10.52	5.18	1.97
1000	27.98	19.62	10.53	5.14	1.91
1100	27.29	20.01	10.70	5.25	1.98
1200	26.70	20.41	10.91	5.39	2.09
1300	26.20	20.83	11.16	5.54	2.19
1400	25.43	20.93	11.33	5.66	2.25
1500	24.91	21.13	11.46	5.70	2.24

REV. X1  
EVA-1500+  
090910  
Page 1 of 5



IF/RF MICROWAVE COMPONENTS • ISO 9001 ISO 14001 AS 9100 CERTIFIED • RoHS compliant  
P.O. Box 350166, Brooklyn, New York 11235-0003 (718) 934-4500 Fax (718) 332-4661



The Design Engineers Search Engine finds the model you need, Instantly • For detailed performance specs & shopping online see



# Voltage Variable Attenuator

# EVA-1500+

## Typical Performance Data

FREQ. (MHz)	INPUT RETURN LOSS Vs. V CONTROL @ V+=3V				
	(dB)				
	@V Control=0V	@V Control=1V	@V Control=1.5V	@V Control=2.5V	@V Control=5V
100	8.97	12.03	17.68	20.25	19.05
200	9.90	13.12	19.23	21.36	19.34
300	10.34	13.74	20.22	22.24	19.76
400	10.65	14.20	21.03	22.94	20.12
500	10.92	14.66	22.01	24.01	20.85
600	11.11	15.03	22.66	24.48	20.97
700	11.25	15.35	23.35	24.99	21.20
800	11.44	15.89	24.80	26.15	21.83
900	11.57	16.08	25.74	28.00	23.12
1000	11.66	16.32	26.08	27.22	22.16
1100	11.72	16.56	27.07	27.31	21.88
1200	11.83	16.96	28.87	27.65	21.81
1300	11.94	17.36	31.82	27.86	21.85
1400	12.02	17.54	34.32	29.73	22.87
1500	12.04	17.69	35.90	28.63	21.85

REV. X1  
EVA-1500+  
090910  
Page 2 of 5



IF/RF MICROWAVE COMPONENTS • ISO 9001 ISO 14001 AS 9100 CERTIFIED RoHS compliant  
P.O. Box 350166, Brooklyn, New York 11235-0003 (718) 934-4500 Fax (718) 332-4661



The Design Engineers Search Engine finds the model you need, Instantly • For detailed performance specs & shopping online see



# Voltage Variable Attenuator

# EVA-1500+

## Typical Performance Data

FREQ. (MHz)	OUTPUT RETURN LOSS Vs. V CONTROL @ V+=3V				
	(dB)				
	@V Control=0V	@V Control=1V	@V Control=1.5V	@V Control=2.5V	@V Control=5V
100	8.95	11.99	17.55	20.15	19.00
200	9.83	13.01	18.91	21.01	19.12
300	10.23	13.53	19.59	21.43	19.18
400	10.48	13.90	20.00	21.66	19.21
500	10.67	14.24	20.48	22.03	19.42
600	10.80	14.46	20.57	21.83	19.13
700	10.90	14.74	20.77	21.83	19.14
800	11.02	15.16	21.26	22.14	19.45
900	11.12	15.30	21.84	22.94	20.07
1000	11.19	15.42	21.48	22.04	19.17
1100	11.29	15.79	21.68	21.85	18.94
1200	11.39	16.15	22.03	21.86	18.96
1300	11.49	16.55	22.49	21.93	19.10
1400	11.60	16.87	23.37	22.69	19.66
1500	11.71	17.23	23.31	21.99	18.87

REV. X1  
EVA-1500+  
090910  
Page 3 of 5



IF/RF MICROWAVE COMPONENTS • ISO 9001 ISO 14001 AS 9100 CERTIFIED RoHS compliant  
P.O. Box 350166, Brooklyn, New York 11235-0003 (718) 934-4500 Fax (718) 332-4661



The Design Engineers Search Engine finds the model you need, Instantly • For detailed performance specs & shopping online see



## Typical Performance Data

FREQ. (MHz)	INPUT IP2 Vs. V CONTROL @ V+=3V (dBm)
	@V Control=5V
100	80.19
200	82.10
300	85.38
400	88.94
500	89.50
600	87.50
700	89.55
800	87.68
900	86.07
1000	87.79
1100	86.83
1200	85.03
1300	86.81
1400	88.86
1500	88.60

FREQ. (MHz)	INPUT IP3 Vs. V CONTROL @ V+=3V (dBm)				
	@V Control=0V	@V Control=1V	@V Control=1.5V	@V Control=2.5V	@V Control=5V
100	16.28	18.41	18.37	20.77	43.76
200	19.83	20.45	21.59	24.25	45.08
300	23.30	23.49	24.58	27.18	50.63
400	25.08	25.22	26.43	29.06	47.86
500	26.73	26.95	27.99	30.64	46.38
600	29.35	28.70	29.53	32.19	48.95
700	29.99	29.46	30.61	33.41	53.40
800	30.12	30.56	31.64	34.34	50.32
900	32.03	32.03	32.52	35.14	51.07
1000	34.35	32.17	33.34	36.02	54.08
1100	32.94	33.10	34.28	36.75	53.03
1200	34.24	34.01	34.69	36.68	49.65
1300	36.43	34.73	35.18	37.21	51.01
1400	35.15	34.80	35.85	37.83	52.13
1500	35.16	35.04	36.21	37.71	50.29

# Voltage Variable Attenuator

# EVA-1500+

## Typical Performance Data

FREQ. (MHz)	PHASE SHIFT Vs. V CONTROL @ V+=3V				
	(deg)				
	@V Control=0V	@V Control=1V	@V Control=1.5V	@V Control=2.5V	@V Control=5V
100	70.51	-8.98	-11.64	-12.46	-12.57
200	58.34	-23.37	-25.67	-26.69	-27.03
300	47.90	-36.16	-38.90	-40.34	-40.84
400	36.85	-48.80	-52.18	-54.04	-54.72
500	26.65	-60.46	-65.02	-67.44	-68.27
600	14.53	-72.84	-78.34	-81.20	-82.21
700	2.73	-85.09	-91.72	-94.91	-96.15
800	-6.83	-96.25	-105.04	-108.75	-110.15
900	-18.43	-104.78	-116.42	-121.10	-122.64
1000	-30.99	-117.64	-130.20	-135.20	-136.89
1100	-42.52	-129.08	-143.74	-149.22	-151.14
1200	-53.82	-139.17	-156.81	-162.96	-165.12
1300	-64.12	-149.17	-170.15	-176.95	-179.21
1400	-74.42	-157.56	-182.15	-189.97	-192.54
1500	-86.52	-168.67	-195.78	-204.30	-207.04

REV. X1  
EVA-1500+  
090910  
Page 5 of 5



IF/RF MICROWAVE COMPONENTS • ISO 9001 ISO 14001 AS 9100 CERTIFIED RoHS compliant

P.O. Box 350166, Brooklyn, New York 11235-0003 (718) 934-4500 Fax (718) 332-4661



The Design Engineers Search Engine finds the model you need, Instantly • For detailed performance specs & shopping online see





# Voltage Variable Attenuator

## Typical Performance Curves

EVA-1500+

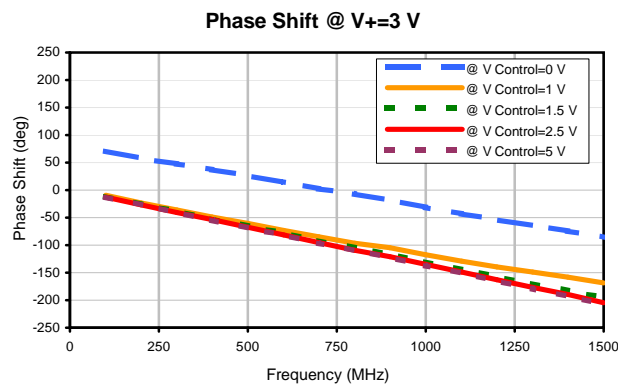
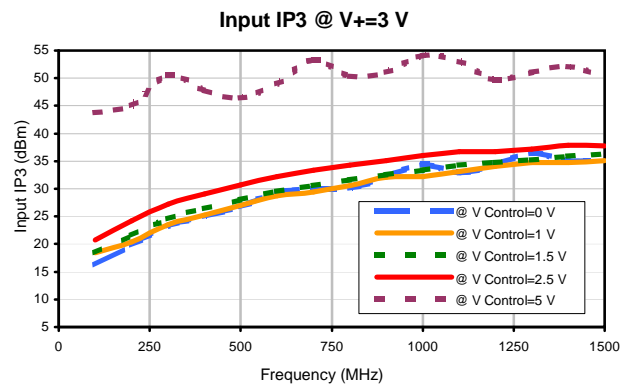
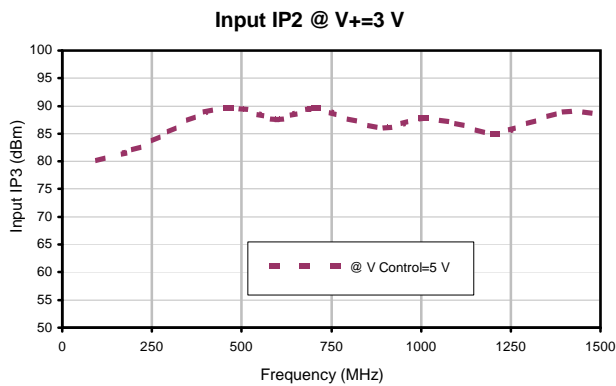
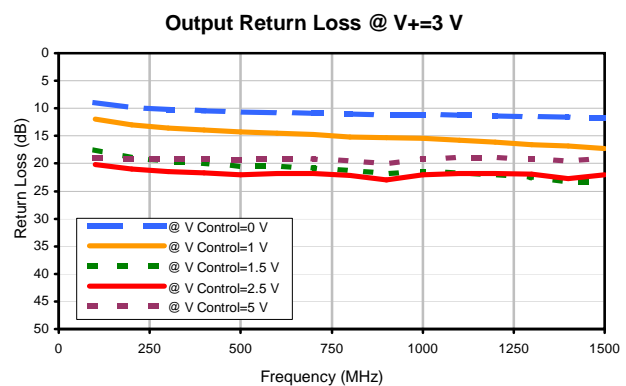
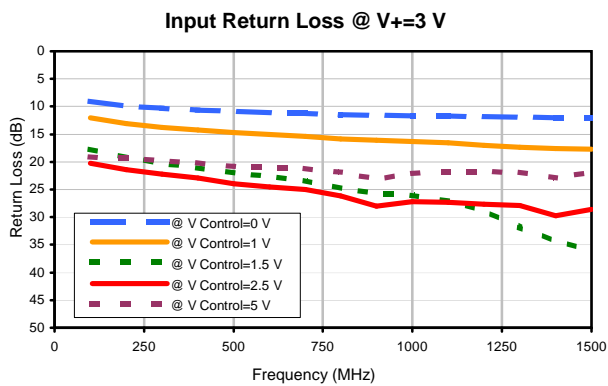
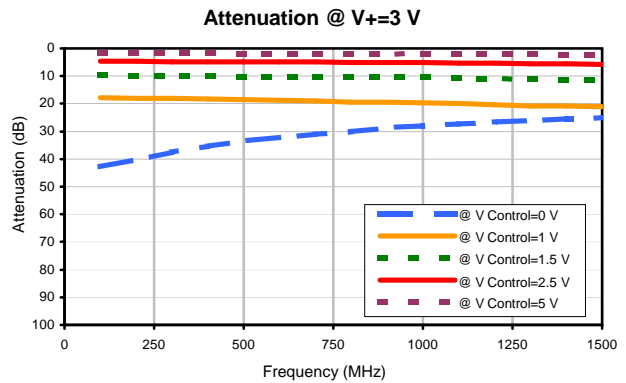
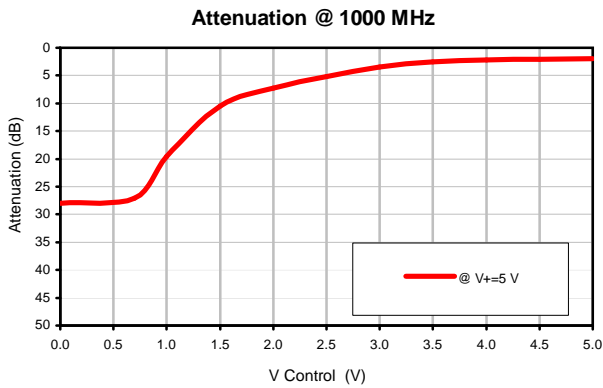

REV. X1  
EVA-1500+  
090910  
Page 1 of 1



IF/RF MICROWAVE COMPONENTS • ISO 9001 ISO 14001 AS 9100 CERTIFIED RoHS compliant  
P.O. Box 350166, Brooklyn, New York 11235-0003 (718) 934-4500 Fax (718) 332-4661



The Design Engineers Search Engine finds the model you need, Instantly • For detailed performance specs & shopping online see





# Tape & Reel Packaging TR-F37

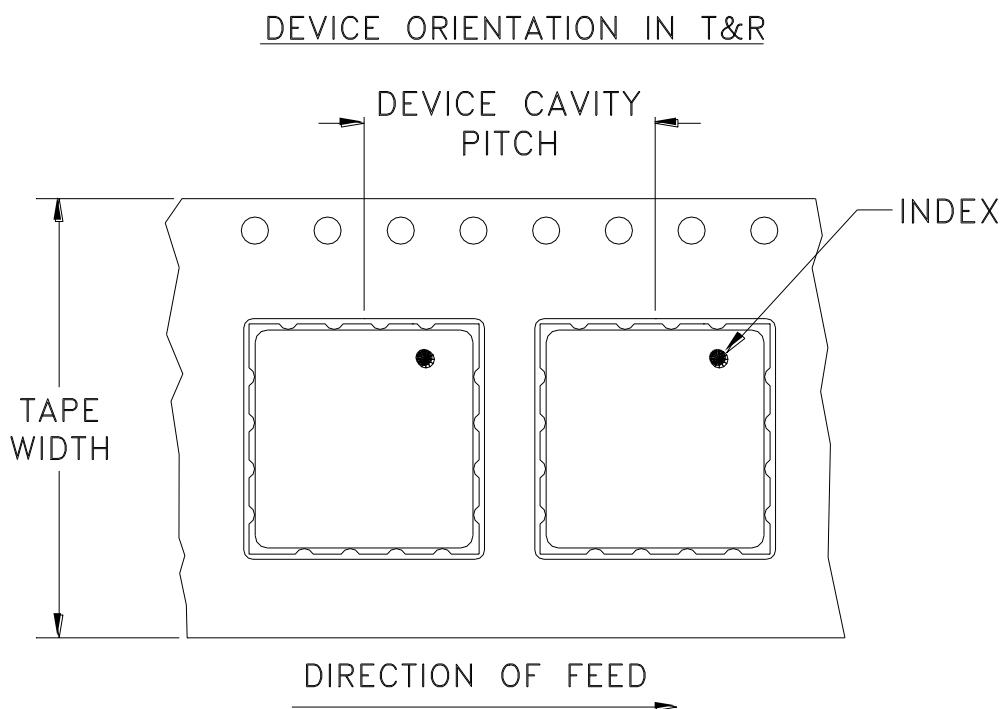

Tape Width, mm	Device Cavity Pitch, mm	Reel Size, inches	Devices per Reel	
24	16	7	Small quantity standards (see note)	10
				20
				50
				100
		13	Standard	200
			500	

Note: Please consult individual model data sheet to determine device per reel availability.

Mini-Circuits carrier tape materials provide protection from ESD (Electro-Static Discharge) during handling and transportation. Tapes are static dissipative and comply with industry standards EIA-481/EIA-541.

Go to: [www.minicircuits.com/pages/pdfs/tape.pdf](http://www.minicircuits.com/pages/pdfs/tape.pdf)



INTERNET <http://www.minicircuits.com>

P.O. Box 350166, Brooklyn, New York 11235-0003 (718) 934-4500 Fax (718) 332-4661

Distribution Centers NORTH AMERICA 800-654-7949 • 417-335-5935 • Fax 417-335-5945 • EUROPE 44-1252-832600 • Fax 44-1252-837010

Mini-Circuits ISO 9001 & ISO 14001 Certified

THIRD ANGLE PROJECTION

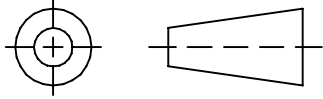

REVISIONS

REV	ECN No.	DESCRIPTION	DATE	DR	AUTH
OR	M116338	NEW RELEASE (FROM RAVON)	03/08	DK	HH
OR	R72078	NEW RELEASE (FROM RAVON)	03/08	DK	HH

SUGGESTED MOUNTING CONFIGURATION FOR  
HE1354 CASE STYLE, "qg" PIN CONNECTION, 50 Ω

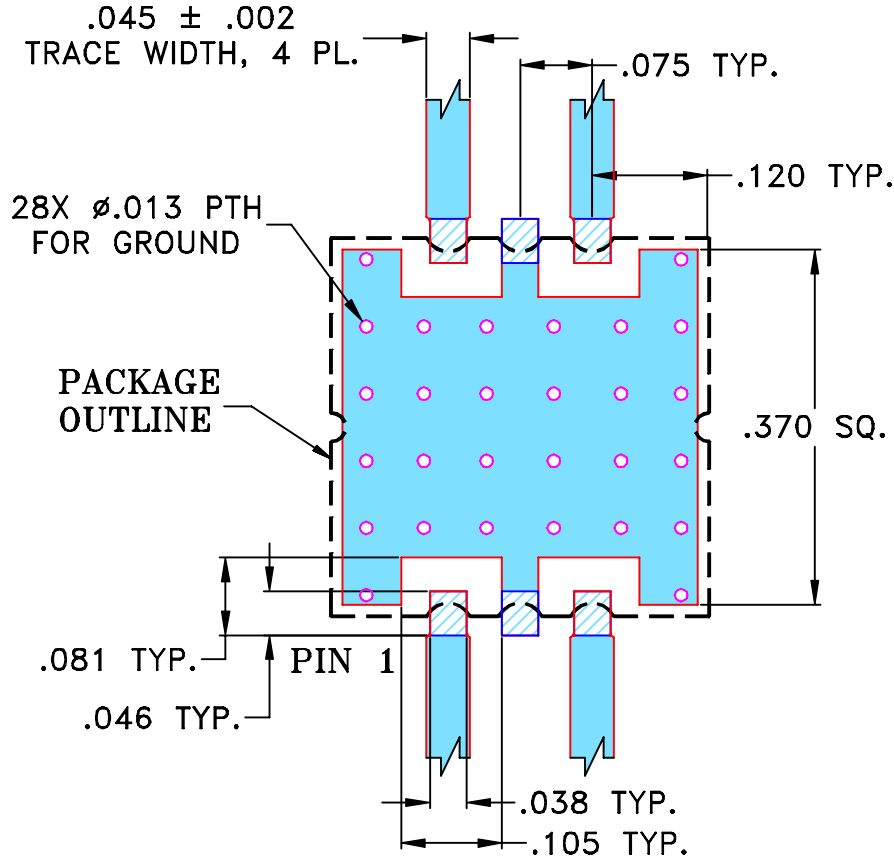

NOTE:

1. TRACE WIDTH IS SHOWN FOR FR4 WITH DIELECTRIC THICKNESS .025"±.002".  
 COPPER: 1/2 OZ. EACH SIDE.  
 FOR OTHER MATERIALS TRACE WIDTH MAY NEED TO BE MODIFIED.
2. BOTTOM SIDE OF THE PCB IS CONTINUOUS GROUND PLANE.

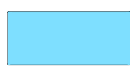

DENOTES PCB COPPER LAYOUT WITH SMOBC  
 (SOLDER MASK OVER BARE COPPER)



DENOTES COPPER LAND PATTERN FREE OF SOLDER MASK

UNLESS OTHERWISE SPECIFIED	INITIALS		DATE
DIMENSIONS ARE IN INCHES TOLERANCES ON: 2 PL DECIMALS ± 3 PL DECIMALS ± .005 ANGLES ± FRACTIONS ±	DRAWN	DK (RAVON)	16 MAR 08
	CHECKED	RZ (RAVON)	16 MAR 08
	APPROVED	HH (RAVON)	16 MAR 08



**Mini-Circuits®** 13 Neptune Avenue  
 Brooklyn NY 11235

PL, qg, HE1354, TB-474+

Mini-Circuits®  
 THIS DOCUMENT AND ITS CONTENTS ARE THE PROPERTY OF MINI-CIRCUITS.  
 EXCEPT FOR USE EXPRESSLY GRANTED, IN WRITING, TO ITS VENDORS, VENDEE  
 AND THE UNITED STATES GOVERNMENT, MINI-CIRCUITS RESERVES ALL PROPRIETARY  
 DESIGN, USE, MANUFACTURING AND REPRODUCTION RIGHTS THERETO.  
 THESE CONTENTS SHALL NOT BE USED, DUPLICATED OR DISCLOSED TO ANY OUTSIDE  
 PARTY, IN WHOLE OR IN PART, WITHOUT WRITTEN PERMISSION OF MINI-CIRCUITS.

SIZE A	CODE IDENT 15542	DRAWING NO: 98-PL-285	REV: OR
FILE: 98PL285	SCALE: 5:1	SHEET: 1 OF 1	

# Evaluation Board and Circuit

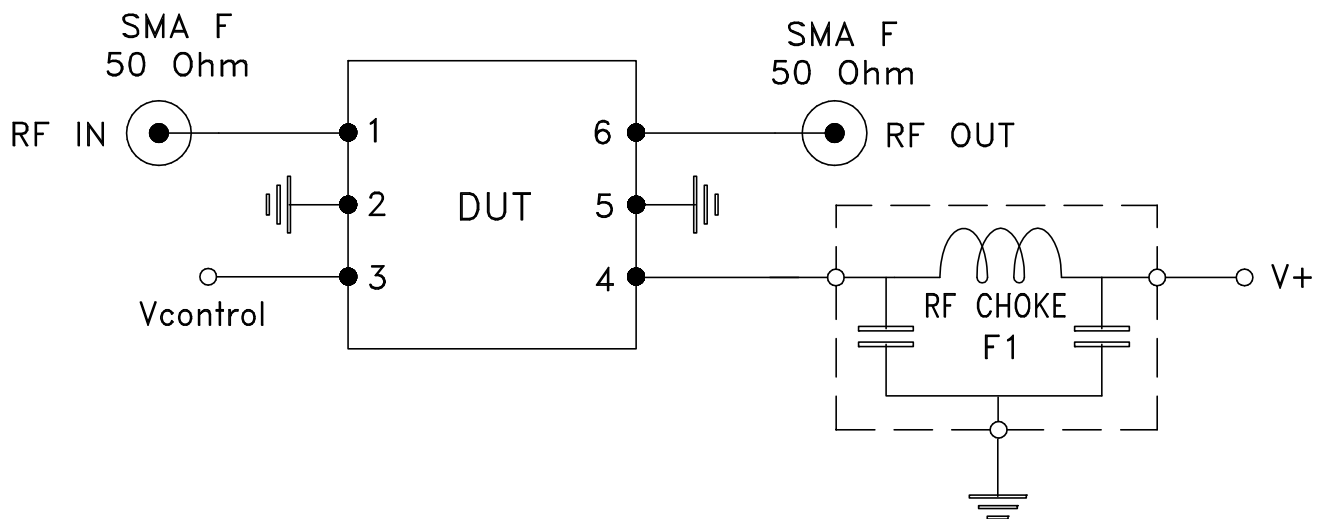
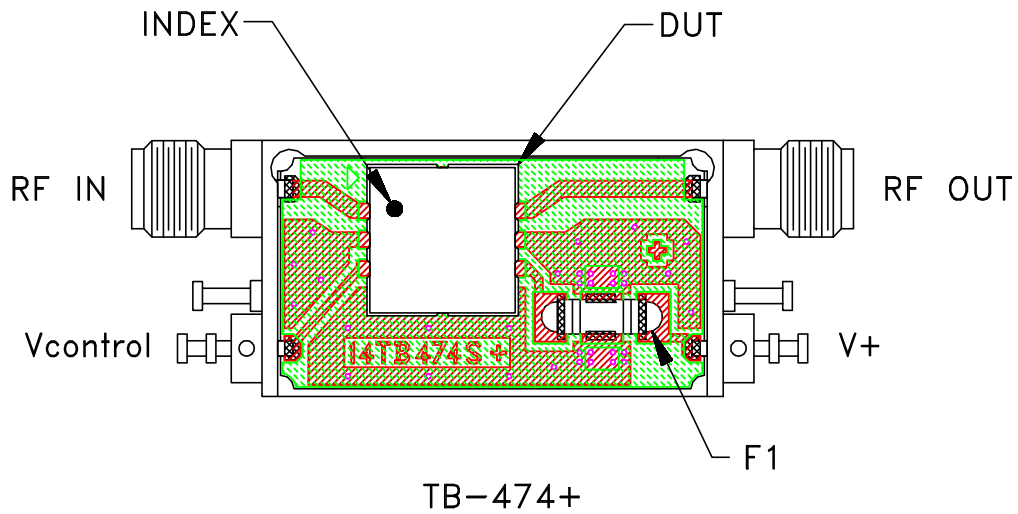

Schematic Diagram

## Notes:

1. SMA Female connectors.
2. PCB Material: FR4 GRADE IT-180TC (ITEQ CORPORATION)  
Dielectric Constant=4.5, Thickness=.025 inch.

 **Mini-Circuits®**



All Mini-Circuits products are manufactured under exacting quality assurance and control standards, and are capable of meeting published specifications after being subjected to any or all of the following physical and environmental test.

Specification	Test/Inspection Condition	Reference/Spec
Operating Temperature	-45° to 85°C Ambient Environment	Individual Model Data Sheet
Storage Temperature	-55° to 100° C Ambient Environment	Individual Model Data Sheet
Humidity	90 to 95% RH, 240 hours, 50°C	MIL-STD-202, Method 103, Condition A, Except 50°C and end-point electrical test done within 12 hours
Thermal Shock	-55° to 100°C, 100 cycles	MIL-STD-202, Method 107, Condition A-3, except +100°C
Solder Reflow Heat	Sn-Pb Eutectic Process: 225°C peak Pb-Free Process, 245°C peak	J-STD-020, Table 4-1, 4-2 and 5-2, Figure 5-1
Solderability	10X Magnification	J-STD-002, Para 4.2.5, Test S, 95% Coverage
Vibration (High Frequency)	20g peak, 20-2000 Hz, 4 times in each of three axes (total 12)	MIL-STD-883, Method 2007.3, Condition A
Mechanical Shock	50g, 11 ms, 1/2-sine, 18 shocks: 3 each direction, each of 3 axes	MIL-STD-202, Method 213, Condition A
Marking Resistance to Solvents	Isopropyl alcohol + mineral spirits at 25°C; terpene defluxer at 25°C; distilled water + proylene glycol monomethyl ether + monoethanolamine at 63°C to 70°C	MIL-STD-202, Method 215