



HIGH DIRECTIVITY

# Monolithic Amplifier

## MNA-6A+

50Ω 0.5 to 2.5 GHz

### THE BIG DEAL

- Integrated matching, DC Blocks and bias circuits
- Excellent Active Directivity, 13-22 dB typ.
- Choice of supply voltage, 2.8V to 5V
- Micro-miniature size .120"X.120"
- Low noise figure, 2.7 dB typ. at 2 GHz
- Output power, up to +20 dBm typ.
- Aqueous washable

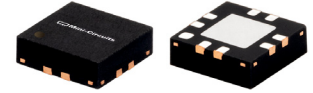

Generic photo used for illustration purposes only

CASE STYLE: DQ849

### +RoHS Compliant

The +Suffix identifies RoHS Compliance. See our website for methodologies and qualifications

### APPLICATIONS

- Buffer amplifier
- Cellular
- PCN
- Communications satellite
- Defense

### PRODUCT OVERVIEW

MNA-6A+ is a wideband PHEMT based MMIC amplifier with high active Directivity. MNA integrates the entire matching network and majority of the bias circuit inside the package, reducing the need for complicated external circuits. This approach makes the MNA amplifier extremely straightforward to use. This design operates on a single 2.8 to 5V supply, is well matched for 50Ω and comes in a tiny, low profile 3x3mm 8-lead MCLP package accommodating dense circuit board layouts.

### KEY FEATURES

Feature	Advantages
Excellent Active Directivity (Isolation- Gain) 13-22 dB	Ideal for use as a buffer amplifier minimizing interaction of adjacent circuits
Integrates DC blocks and RF choke	Minimizes external components, component count and circuit area.
Single 2.8 to +5V operation	Amplifier can be used at low voltage such as +3V or standard +5V. +5V operation results in higher P1dB and OIP3.
3 x 3mm 8-lead MCLP package	Tiny footprint saves space in dense layouts while providing low inductance, repeatable transitions, and excellent thermal contact to the PCB.

REV. A  
ECO-011187  
MCL NY  
221003





HIGH DIRECTIVITY

# Monolithic Amplifier

## MNA-6A+

### ELECTRICAL SPECIFICATIONS<sup>1</sup> AT 25°C

Parameter	Condition (GHz)	Vs=5V			Vs=2.8V Typ.	Units
		Min.	Typ.	Max.		
Frequency Range		0.5		2.5	0.5-2.5	GHz
Gain	0.5		22.3		20.4	dB
	0.75		24.4		22.0	
	1.0		25.0		22.3	
	1.5		25.3		22.3	
	2.0	22.3	24.8	27.3	21.6	
	2.5		23.2		20.4	
Input Return Loss	0.5		6.3		6.9	dB
	0.75		10.9		11.2	
	1.0		14.2		13.9	
	1.5		17.4		16.3	
	2.0		17.6		17.5	
	2.5		14.9		15.4	
Output Return Loss	0.5		10.9		9.8	dB
	0.75		17.8		13.3	
	1.0		27.2		14.9	
	1.5		24.1		15.3	
	2.0		19.5		14.8	
	2.5		19.4		15.2	
Output Power at P1dB	0.5		20.3		11.1	dBm
	0.75		20.3		11.6	
	1.0		20.2		11.9	
	1.5		19.9		11.8	
	2.0		19.4		12.2	
	2.5		19.2		12.5	
Output IP3	0.5		33.2		22.8	dBm
	0.75		33.0		23.3	
	1.0		32.4		23.7	
	1.5		31.4		23.5	
	2.0		30.4		23.8	
	2.5		30.0		24.1	
Noise Figure (dB)	0.5		3.1		3.2	dB
	0.75		2.8		2.9	
	1.0		2.6		2.7	
	1.5		2.6		2.7	
	2.0		2.7		2.7	
	2.5		2.7		2.8	
Directivity (Isolation-Gain)	0.5		22.1		24.9	dB
	0.75		21.1		22.0	
	1.0		18.7		19.2	
	1.5		15.1		15.5	
	2.0		13.3		13.6	
	2.5		13.2		13.0	
DC Current			99	110	92	mA
Device Current Variation vs. Temperature <sup>(2)</sup>			41		37	µA/°C
Device Current Variation vs Voltage			0.0017 <sup>(3)</sup>		0.0044 <sup>(4)</sup>	mA/mV
Thermal resistance at 85°C (Junction to Lead)			46		46	°C/W

(1) Measured on Mini-Circuits Characterization test board TB-186+. See Characterization Test Circuit (Fig. 1)

(2) (Current at 85°C - Current at -45°C)/130

(3) (Current at 5.25V - Current at 3.9V)/1.35

(4) (Current at 3.9V - Current at 2.66V)/1.24



HIGH DIRECTIVITY

# Monolithic Amplifier

# MNA-6A+

## MAXIMUM RATINGS<sup>5</sup>

Parameter	Ratings
Operating Temperature	-40°C to 85°C
Storage Temperature	-55°C to 100°C
DC Voltage	7V at pad 7 (on TB-186+) 1V at pads 2 & 5
Power Dissipation	970 mW
Input Power	10dBm (continuous operation) 26dBm (5 minutes max)

5. Permanent damage may occur if any of these limits are exceeded. These ratings are not intended for continuous normal operation.

## SIMPLIFIED SCHEMATIC AND PAD DESCRIPTION

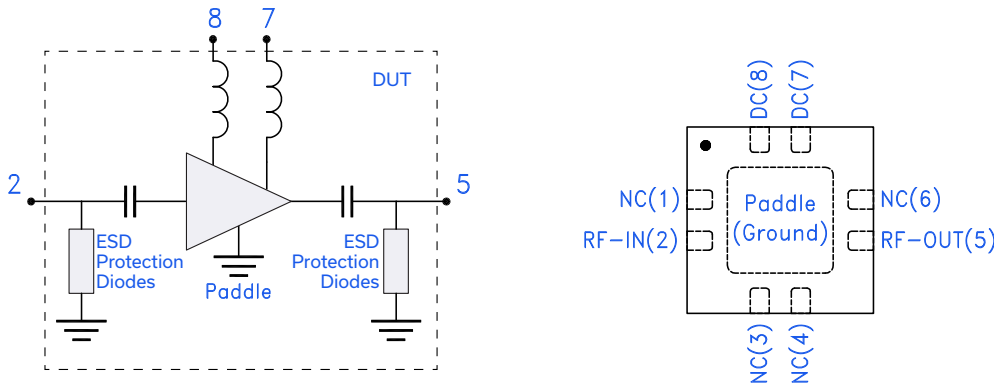

Function	Pad Number	Description (See Fig 1)
RF-IN	2	RF input pin
RF-OUT	5	RF output pin
DC	7,8	DC Bias pads 7,8. Pad 7 connected to ground via 1000 pF. Pad 8 connected to pad 7 via 33.2 ohms.
NC	1,3,4,6	Not Connected, connect pad 3 and 4 to ground externally
GND	Paddle	Ground
OPTIONAL	1,6	No internal connection; recommended use: per PCB Layout PL-078



## CHARACTERIZATION & APPLICATION TEST CIRCUIT

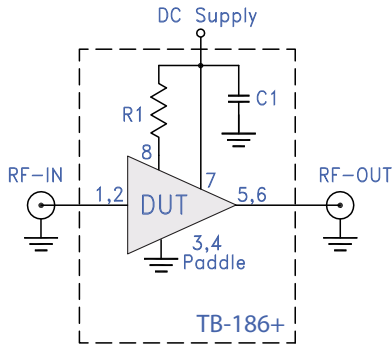

Fig 1. Block Diagram of Test Circuit used for characterization. (DUT soldered on Mini-Circuits Characterization test board TB-313)

Gain, Return loss, Output power at 1dB compression (P1 dB) , output IP3 (OIP3) and noise figure measured using Agilent's N5242A PNA-X microwave network analyzer.

Conditions:

1. Gain and Return loss: Pin= -25dBm
2. Output IP3 (OIP3): Two tones, spaced 1 MHz apart, 0 dBm/tone at output.

Component	Size	Value	Units
R1	0805	33.2	$\Omega$
C1	0402	1000	$\rho F$

## RECOMMENDED APPLICATION CIRCUIT

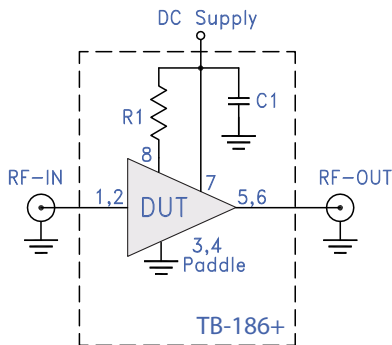
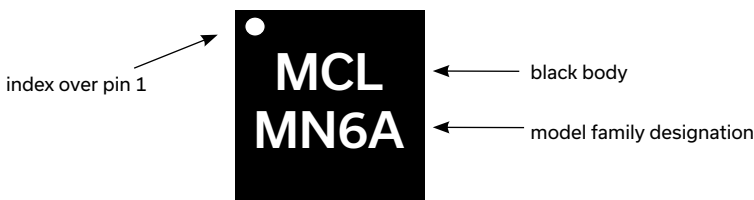

Fig 2. Test Board includes case, connectors, and components soldered to PCB

Component	Size	Value	Units
R1	0805	33.2	$\Omega$
C1	0402	1000	$\rho F$

## PRODUCT MARKING



Marking may contain other features or characters for internal lot control



HIGH DIRECTIVITY

# Monolithic Amplifier

## MNA-6A+

Mini-Circuits

ADDITIONAL DETAILED TECHNICAL INFORMATION IS AVAILABLE ON OUR DASH BOARD. TO ACCESS [CLICK HERE](#)

Performance Data	Data Table Swept Graphs S-Parameter (S2P Files) Data Set (.zip file)
Case Style	DQ849 3x3x0.9 mm MCLP Plastic package, exposed paddle lead finish: Matte-Tin
Tape & Reel Standard quantities available on reel	F104 7" reels with 20, 50, 100, 200, 500, 1K, or 2K devices
Suggested Layout for PCB Design	PL-078
Evaluation Board	TB-186-6A+
Environmental Ratings	ENV08T1

### ESD RATING

Human Body Model (HBM): Class 1A (250 to <500V) in accordance with ANSI/ESD STM 5.1 - 2001

### MSL RATING

Moisture Sensitivity: MSL1 in accordance with IPC/JEDEC J-STD-020D

### MSL TEST FLOW CHART

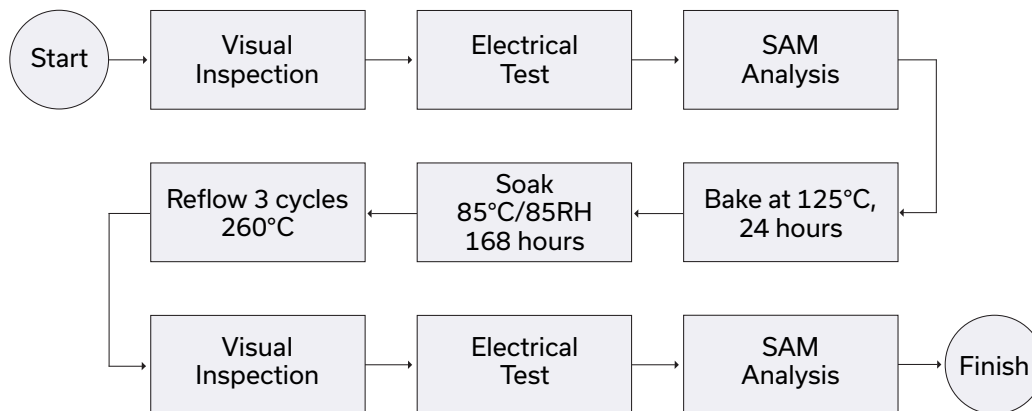

- NOTES**
- A. Performance and quality attributes and conditions not expressly stated in this specification document are intended to be excluded and do not form a part of this specification document.
  - B. Electrical specifications and performance data contained in this specification document are based on Mini-Circuit's applicable established test performance criteria and measurement instructions.
  - C. The parts covered by this specification document are subject to Mini-Circuits standard limited warranty and terms and conditions (collectively, "Standard Terms"); Purchasers of this part are entitled to the rights and benefits contained therein. For a full statement of the standard. Terms and the exclusive rights and remedies thereunder, please visit Mini-Circuits' website at [www.minicircuits.com/MCLStore/terms.jsp](http://www.minicircuits.com/MCLStore/terms.jsp)



## Typical Performance Data

**NOTE: Use PDF Bookmarks to view DATA at required conditions**

**Definitions:**

Input Return Loss = -S11 (dB)

Gain(Power Gain) = S21 (dB)

Reverse Isolation = -S12 (dB)

Output Return Loss = -S22 (dB)

TEST CONDITIONS: Vd = 5V, Id = 98.44 mA @ Temperature = +25degC

FREQ	Gain	Isolation	Input Return Loss	Output Return Loss	Stability		IP-3 Output	1dB Comp. Output	Noise Figure
					K	Measure			
(MHz)	(dB)	(dB)	(dB)	(dB)	K	Measure	(dBm)	(dBm)	(dB)
200	6.80	47.63	3.29	2.72	13.17	0.69	26.62	13.25	6.49
300	15.41	44.15	3.57	5.80	5.33	1.08	32.17	18.67	4.23
400	20.00	43.81	4.64	8.44	4.17	1.18	33.66	20.20	3.52
500	22.35	45.60	6.26	10.90	4.99	1.15	34.08	20.62	4.27
600	23.55	45.89	8.24	13.59	5.28	1.11	33.58	20.72	3.02
700	24.23	45.95	10.03	16.60	5.37	1.08	34.36	20.63	2.93
800	24.63	45.37	11.69	19.86	5.05	1.05	33.67	20.58	2.71
1000	25.08	44.26	14.22	28.77	4.43	1.03	33.11	20.57	2.61
1100	25.21	43.65	15.21	38.39	4.11	1.02	32.98	20.48	2.61
1200	25.31	42.76	16.09	38.52	3.70	1.01	32.15	20.28	2.61
1300	25.37	42.02	16.84	30.16	3.40	1.00	32.28	20.19	2.60
1400	25.40	41.49	17.44	26.45	3.21	0.99	32.25	20.13	2.56
1500	25.38	40.89	18.09	23.86	3.01	0.98	31.81	20.08	2.59
1600	25.44	40.28	17.67	21.84	2.79	0.98	31.65	19.97	2.68
1700	25.32	39.80	18.07	21.50	2.69	0.97	31.61	20.00	2.64
1800	25.19	39.30	18.29	20.98	2.58	0.97	31.35	19.73	2.65
1900	25.06	38.98	18.25	20.11	2.52	0.96	31.08	19.76	2.62
2000	24.89	38.50	18.14	19.16	2.44	0.96	31.07	19.76	2.61
2100	24.64	37.79	17.67	19.77	2.32	0.96	30.72	19.67	2.54
2200	24.41	37.49	17.55	19.27	2.30	0.96	30.42	19.33	2.62
2300	24.18	37.33	17.42	18.72	2.31	0.96	30.64	19.47	2.70
2400	23.82	36.78	16.58	19.40	2.26	0.96	30.47	19.44	2.78
2500	23.38	37.07	15.15	20.92	2.43	0.98	30.61	19.49	2.67
2600	23.21	36.88	15.69	18.96	2.42	0.97	30.28	19.44	2.75
2700	22.55	36.26	14.01	22.47	2.42	0.99	30.49	19.32	2.80
2800	22.23	35.93	13.70	21.33	2.41	0.99	30.41	19.36	2.91
2900	21.86	35.49	13.43	20.77	2.38	0.99	30.42	19.25	2.95
3000	21.12	36.30	12.19	25.83	2.79	1.02	30.50	19.22	2.87
3100	20.82	35.31	11.93	23.05	2.57	1.02	30.25	19.10	2.90
3200	20.28	35.45	11.04	23.95	2.73	1.04	29.97	18.98	2.89
3300	19.96	34.58	10.95	22.68	2.57	1.03	30.15	19.09	2.93
3400	19.19	35.59	10.24	28.81	3.07	1.07	30.41	19.01	3.00
3500	19.03	34.41	9.83	23.46	2.73	1.06	30.03	18.85	2.97
3600	18.55	34.40	9.62	23.80	2.85	1.07	30.01	18.77	2.99
3700	18.06	34.67	9.25	24.41	3.06	1.09	30.29	18.66	3.05
3800	17.47	35.38	8.78	26.02	3.48	1.11	30.36	18.65	3.20
3900	17.19	34.74	8.63	23.49	3.33	1.11	29.97	18.50	3.18
4000	16.82	34.73	8.18	22.36	3.41	1.12	29.51	18.30	3.20

## Typical Performance Data

### Definitions:

Input Return Loss = -S11 (dB)

Gain(Power Gain) = S21 (dB)

Reverse Isolation = -S12 (dB)

Output Return Loss = -S22 (dB)

TEST CONDITIONS: Vd = 3.9V, Id =96.61 mA @ Temperature = +25degC

FREQ	Gain	Isolation	Input Return Loss	Output Return Loss	Stability		IP-3 Output	1dB Comp. Output	Noise Figure
					K	Measure			
(MHz)	(dB)	(dB)	(dB)	(dB)	K	Measure	(dBm)	(dBm)	(dB)
200	6.63	47.66	3.30	2.75	13.58	0.70	24.82	11.82	6.52
300	15.13	44.28	3.60	5.74	5.60	1.08	28.89	16.31	4.26
400	19.61	44.82	4.72	8.25	4.94	1.16	30.12	17.61	3.56
500	21.87	46.36	6.42	10.63	5.80	1.13	30.51	18.05	4.39
600	22.98	45.90	8.41	12.99	5.64	1.09	30.26	18.20	3.05
700	23.59	46.00	10.18	15.43	5.78	1.07	30.54	18.12	2.94
800	23.94	44.79	11.78	17.71	5.07	1.05	30.34	18.11	2.74
1000	24.31	43.47	14.14	21.56	4.37	1.02	30.48	18.41	2.63
1100	24.41	43.04	15.03	22.82	4.16	1.02	30.35	18.18	2.62
1200	24.47	41.61	15.73	23.48	3.55	1.01	29.92	17.94	2.63
1300	24.49	41.31	16.40	23.35	3.43	1.00	30.15	18.02	2.64
1400	24.49	40.60	16.98	22.70	3.19	0.99	30.30	18.13	2.59
1500	24.45	40.11	17.57	22.19	3.04	0.99	29.88	18.08	2.60
1600	24.48	39.49	17.08	20.42	2.82	0.98	29.92	18.00	2.74
1700	24.35	38.77	17.41	20.66	2.65	0.98	29.81	18.06	2.60
1800	24.21	38.34	17.68	20.60	2.57	0.97	29.85	18.15	2.67
1900	24.08	37.95	17.73	20.05	2.50	0.97	30.00	18.19	2.64
2000	23.91	37.35	17.59	19.62	2.39	0.96	29.79	18.14	2.64
2100	23.68	36.77	17.09	20.04	2.29	0.96	29.60	18.04	2.65
2200	23.47	36.56	16.95	20.05	2.29	0.96	29.63	18.02	2.71
2300	23.26	36.39	16.89	19.61	2.30	0.96	29.65	18.09	2.68
2400	22.93	35.91	16.18	20.40	2.26	0.97	29.70	18.15	2.72
2500	22.54	35.75	14.83	20.80	2.29	0.98	29.56	18.01	2.76
2600	22.39	35.80	15.14	19.53	2.34	0.98	29.48	17.87	2.79
2700	21.78	34.95	13.65	23.71	2.27	0.99	29.70	18.12	2.83
2800	21.50	34.78	13.39	23.06	2.29	1.00	29.62	18.03	2.79
2900	21.17	34.44	13.17	22.50	2.28	1.00	29.69	17.98	2.86
3000	20.49	35.11	11.99	27.99	2.61	1.03	29.71	17.80	2.87
3100	20.21	34.21	11.64	26.10	2.42	1.03	29.49	17.82	2.90
3200	19.72	34.09	10.81	27.58	2.49	1.05	29.53	17.85	2.88
3300	19.42	33.47	10.81	26.60	2.40	1.04	29.47	17.76	2.89
3400	18.72	34.30	10.23	28.85	2.80	1.07	29.74	17.81	2.98
3500	18.55	33.57	9.76	29.33	2.61	1.07	29.60	17.70	2.94
3600	18.11	33.15	9.48	28.90	2.60	1.08	29.35	17.63	2.96
3700	17.65	33.39	9.17	30.93	2.78	1.09	29.70	17.68	3.03
3800	17.09	33.95	8.82	40.18	3.10	1.11	29.57	17.62	3.17
3900	16.85	33.26	8.69	28.21	2.94	1.11	29.36	17.47	3.13
4000	16.49	33.29	8.28	25.64	3.02	1.12	28.99	17.20	3.18

## Typical Performance Data

### Definitions:

Input Return Loss = -S11 (dB)

Gain(Power Gain) = S21 (dB)

Reverse Isolation = -S12 (dB)

Output Return Loss = -S22 (dB)

TEST CONDITIONS: Vd = 5.25V, Id = 98.63 mA @ Temperature = +25degC

FREQ	Gain	Isolation	Input Return Loss	Output Return Loss	Stability		IP-3 Output	1dB Comp. Output	Noise Figure
					K	Measure			
(MHz)	(dB)	(dB)	(dB)	(dB)	K	Measure	(dBm)	(dBm)	(dB)
200	6.82	47.24	3.28	2.71	12.49	0.69	26.76	13.34	6.49
300	15.45	44.21	3.55	5.80	5.32	1.09	32.45	19.03	4.23
400	20.06	43.85	4.61	8.46	4.15	1.18	33.60	20.59	3.56
500	22.43	45.03	6.23	10.94	4.62	1.15	34.74	21.01	4.34
600	23.64	46.12	8.21	13.63	5.36	1.11	34.16	21.12	3.03
700	24.33	45.95	9.99	16.68	5.31	1.08	34.12	21.05	2.93
800	24.74	45.55	11.67	20.02	5.09	1.05	33.79	20.97	2.74
1000	25.20	44.13	14.24	28.89	4.30	1.02	33.35	20.89	2.64
1100	25.35	43.33	15.24	35.88	3.91	1.01	33.18	20.82	2.66
1200	25.45	42.79	16.07	33.78	3.66	1.00	32.91	20.62	2.64
1300	25.52	42.24	16.88	28.47	3.43	1.00	32.41	20.51	2.61
1400	25.55	41.51	17.59	25.50	3.16	0.99	32.43	20.41	2.59
1500	25.54	41.38	18.27	23.12	3.12	0.98	32.23	20.34	2.61
1600	25.61	40.52	17.76	21.44	2.81	0.98	31.82	20.22	2.78
1700	25.50	39.75	18.11	20.98	2.62	0.97	31.75	20.22	2.61
1800	25.36	39.26	18.41	20.46	2.52	0.96	31.32	19.90	2.71
1900	25.23	38.96	18.51	19.68	2.48	0.96	31.21	19.94	2.63
2000	25.05	38.69	18.31	18.84	2.44	0.96	30.99	19.95	2.62
2100	24.81	38.04	17.76	19.39	2.34	0.96	30.80	19.84	2.64
2200	24.57	37.63	17.67	18.80	2.30	0.95	30.60	19.46	2.75
2300	24.34	37.52	17.60	18.31	2.32	0.95	30.56	19.62	2.67
2400	23.97	37.06	16.81	18.97	2.29	0.96	30.56	19.56	2.76
2500	23.52	37.41	15.26	20.60	2.48	0.98	30.58	19.66	2.78
2600	23.34	37.29	15.71	18.61	2.50	0.97	30.42	19.65	2.82
2700	22.67	36.48	14.06	21.93	2.45	0.99	30.57	19.45	2.89
2800	22.35	36.18	13.81	20.79	2.45	0.99	30.38	19.50	2.79
2900	21.97	35.68	13.58	20.38	2.41	0.99	30.51	19.41	2.81
3000	21.22	36.57	12.24	24.97	2.84	1.02	30.36	19.40	2.83
3100	20.91	35.53	11.92	22.53	2.61	1.02	30.23	19.26	2.89
3200	20.37	35.46	11.01	23.28	2.71	1.04	30.07	19.10	2.88
3300	20.04	34.80	11.01	22.14	2.61	1.03	30.27	19.25	2.89
3400	19.27	35.85	10.31	27.89	3.14	1.07	30.55	19.17	2.94
3500	19.09	34.81	9.85	22.83	2.83	1.06	30.14	18.98	2.92
3600	18.61	34.46	9.54	23.19	2.85	1.07	29.97	18.91	2.96
3700	18.12	34.89	9.17	23.75	3.11	1.09	30.25	18.77	3.01
3800	17.53	35.66	8.75	25.28	3.56	1.11	30.29	18.77	3.15
3900	17.25	34.93	8.63	23.03	3.38	1.11	29.86	18.65	3.14
4000	16.86	34.64	8.17	21.90	3.36	1.12	29.43	18.47	3.16



## Typical Performance Data

### Definitions:

Input Return Loss = -S11 (dB)

Gain(Power Gain) = S21 (dB)

Reverse Isolation = -S12 (dB)

Output Return Loss = -S22 (dB)

TEST CONDITIONS: Vd = 5V, Id =94.34 mA @ Temperature = -45degC

FREQ	Gain	Isolation	Input Return Loss	Output Return Loss	Stability		IP-3 Output	1dB Comp. Output	Noise Figure
					K	Measure			
(MHz)	(dB)	(dB)	(dB)	(dB)	K	Measure	(dBm)	(dBm)	(dB)
200	6.94	47.78	3.14	2.70	12.72	0.70	27.12	12.82	5.79
300	15.73	43.54	3.43	5.89	4.67	1.10	33.23	18.71	3.63
400	20.37	43.54	4.45	8.45	3.76	1.19	34.50	20.24	3.02
500	22.79	45.79	5.99	11.00	4.76	1.17	35.35	20.69	3.73
600	23.99	45.95	7.98	13.59	4.99	1.12	34.97	20.79	2.54
700	24.72	45.94	9.76	16.63	5.04	1.08	34.63	20.74	2.49
800	25.16	45.63	11.49	20.20	4.88	1.05	34.18	20.66	2.25
1000	25.67	44.41	14.30	27.40	4.22	1.02	33.47	20.56	2.16
1100	25.84	43.79	15.33	30.08	3.90	1.01	33.23	20.50	2.14
1200	25.97	43.09	16.16	28.96	3.57	1.00	32.40	20.34	2.15
1300	26.05	42.43	16.89	26.44	3.30	0.99	32.02	20.20	2.16
1400	26.11	41.60	17.42	24.51	3.00	0.98	32.29	20.09	2.11
1500	26.12	41.33	18.10	22.35	2.91	0.98	31.70	20.07	2.12
1600	26.22	40.75	17.74	20.72	2.69	0.97	31.49	19.93	2.25
1700	26.14	40.10	18.09	20.17	2.54	0.96	31.23	19.95	2.11
1800	26.03	39.63	18.43	19.96	2.45	0.96	31.05	19.60	2.14
1900	25.92	39.34	18.62	19.54	2.40	0.96	31.23	19.61	2.13
2000	25.75	38.86	18.51	19.05	2.32	0.95	30.93	19.67	2.11
2100	25.53	38.27	18.00	19.35	2.23	0.95	30.92	19.57	2.10
2200	25.31	37.98	17.86	18.78	2.21	0.95	30.42	19.16	2.17
2300	25.08	37.80	17.74	18.27	2.21	0.95	30.41	19.33	2.16
2400	24.69	37.54	16.90	18.96	2.24	0.95	30.56	19.30	2.28
2500	24.27	37.43	15.49	20.03	2.30	0.97	30.30	19.46	2.20
2600	24.06	37.04	15.88	18.45	2.26	0.96	30.67	19.43	2.25
2700	23.39	36.68	14.11	21.90	2.32	0.98	30.88	19.19	2.28
2800	23.06	36.17	13.86	20.98	2.27	0.98	30.58	19.31	2.23
2900	22.67	35.92	13.53	20.71	2.30	0.98	30.61	19.30	2.27
3000	21.89	36.88	12.29	26.62	2.74	1.02	30.54	19.22	2.28
3100	21.59	36.00	11.97	23.58	2.56	1.02	30.34	19.04	2.29
3200	21.03	35.79	10.99	24.25	2.61	1.04	30.36	18.87	2.31
3300	20.67	35.10	11.09	23.59	2.53	1.03	30.51	19.12	2.36
3400	20.09	35.25	10.45	25.52	2.70	1.05	30.51	19.00	2.35
3500	19.64	35.28	9.82	24.87	2.80	1.07	30.27	18.79	2.34
3600	19.21	34.85	9.47	24.15	2.78	1.07	30.23	18.75	2.36
3700	18.68	34.95	9.16	25.06	2.95	1.09	30.45	18.57	2.43
3800	18.14	36.13	8.62	24.33	3.49	1.11	30.60	18.66	2.50
3900	17.81	35.38	8.49	23.89	3.32	1.11	29.45	18.49	2.51
4000	17.43	34.46	8.09	23.53	3.09	1.12	28.43	18.26	2.56

## Typical Performance Data

### Definitions:

Input Return Loss = -S11 (dB)

Gain(Power Gain) = S21 (dB)

Reverse Isolation = -S12 (dB)

Output Return Loss = -S22 (dB)

TEST CONDITIONS: Vd = 3.9V, Id = 92.63 mA @ Temperature = -45degC

FREQ	Gain	Isolation	Input Return Loss	Output Return Loss	Stability		IP-3 Output	1dB Comp. Output	Noise Figure
					K	Measure			
(MHz)	(dB)	(dB)	(dB)	(dB)	K	Measure	(dBm)	(dBm)	(dB)
200	6.81	47.05	3.16	2.71	11.89	0.70	25.96	12.10	5.80
300	15.55	44.62	3.47	5.87	5.48	1.10	30.84	16.72	3.64
400	20.12	43.90	4.55	8.39	4.10	1.18	32.14	17.98	3.02
500	22.47	46.17	6.12	10.93	5.21	1.16	33.46	18.42	3.78
600	23.61	46.17	8.10	13.47	5.37	1.11	33.25	18.56	2.54
700	24.29	46.02	9.85	16.43	5.34	1.08	33.67	18.48	2.46
800	24.69	45.89	11.51	19.89	5.30	1.06	33.47	18.47	2.24
1000	25.14	43.96	14.11	27.82	4.24	1.02	33.67	18.79	2.17
1100	25.28	43.41	15.01	34.18	3.96	1.02	33.44	18.57	2.15
1200	25.37	42.69	15.76	36.73	3.64	1.01	32.98	18.31	2.16
1300	25.43	42.31	16.33	31.21	3.48	1.00	32.76	18.39	2.12
1400	25.46	41.25	16.75	27.76	3.10	0.99	33.19	18.53	2.10
1500	25.44	40.80	17.30	24.58	2.95	0.98	32.67	18.47	2.11
1600	25.51	40.38	16.95	22.36	2.79	0.98	32.93	18.44	2.26
1700	25.42	39.60	17.22	21.71	2.59	0.97	32.79	18.51	2.08
1800	25.30	39.04	17.53	21.41	2.48	0.97	32.27	18.57	2.13
1900	25.19	38.60	17.68	20.87	2.39	0.96	32.27	18.61	2.15
2000	25.03	38.32	17.59	20.19	2.36	0.96	32.12	18.60	2.12
2100	24.83	37.89	17.11	20.40	2.30	0.96	31.92	18.52	2.12
2200	24.63	37.48	16.95	19.69	2.24	0.96	31.76	18.45	2.13
2300	24.43	37.15	16.86	19.02	2.21	0.95	31.75	18.54	2.15
2400	24.07	36.97	16.13	19.73	2.24	0.96	31.79	18.60	2.23
2500	23.71	36.94	14.89	20.50	2.31	0.98	31.69	18.47	2.17
2600	23.52	36.41	15.20	18.94	2.23	0.96	31.51	18.35	2.23
2700	22.90	35.97	13.65	22.31	2.26	0.99	31.49	18.50	2.30
2800	22.61	35.79	13.39	21.34	2.27	0.99	31.50	18.52	2.29
2900	22.26	35.39	13.11	20.91	2.26	0.99	32.00	18.48	2.32
3000	21.52	36.21	12.07	26.89	2.64	1.02	31.90	18.28	2.31
3100	21.26	35.10	11.74	23.69	2.40	1.02	31.57	18.29	2.32
3200	20.76	35.09	10.83	24.03	2.49	1.04	31.53	18.27	2.31
3300	20.42	34.52	10.98	23.47	2.44	1.03	31.57	18.19	2.30
3400	19.87	34.59	10.40	25.20	2.57	1.05	31.86	18.16	2.33
3500	19.46	34.55	9.81	24.65	2.64	1.06	31.77	18.11	2.35
3600	19.05	34.06	9.50	23.97	2.60	1.07	31.69	18.01	2.38
3700	18.55	34.32	9.24	24.92	2.80	1.08	32.07	18.05	2.44
3800	18.02	35.45	8.77	24.50	3.30	1.11	31.92	18.00	2.54
3900	17.74	34.58	8.66	23.42	3.08	1.10	32.40	17.78	2.53
4000	17.38	33.83	8.26	22.73	2.92	1.11	32.26	17.53	2.55

## Typical Performance Data

### Definitions:

Input Return Loss = -S11 (dB)

Gain(Power Gain) = S21 (dB)

Reverse Isolation = -S12 (dB)

Output Return Loss = -S22 (dB)

TEST CONDITIONS: Vd = 5.25V, Id = 94.68 mA @ Temperature = -45degC

FREQ	Gain	Isolation	Input Return Loss	Output Return Loss	Stability		IP-3 Output	1dB Comp. Output	Noise Figure
					K	Measure			
(MHz)	(dB)	(dB)	(dB)	(dB)	K	Measure	(dBm)	(dBm)	(dB)
200	6.95	47.34	3.14	2.70	12.03	0.70	27.22	12.85	5.76
300	15.76	43.68	3.42	5.89	4.72	1.11	32.95	18.97	3.66
400	20.40	43.67	4.44	8.45	3.80	1.19	34.94	20.59	3.00
500	22.83	46.00	5.96	11.00	4.84	1.17	35.43	21.03	3.74
600	24.04	45.81	7.96	13.60	4.88	1.12	35.49	21.13	2.55
700	24.77	46.03	9.76	16.66	5.06	1.08	35.32	21.08	2.47
800	25.22	45.74	11.48	20.22	4.91	1.06	34.39	21.00	2.28
1000	25.74	44.62	14.32	27.06	4.28	1.02	33.80	20.80	2.18
1100	25.92	43.67	15.35	29.46	3.81	1.01	33.72	20.79	2.17
1200	26.05	43.26	16.23	28.09	3.61	1.00	32.86	20.62	2.16
1300	26.14	42.43	16.96	25.94	3.27	0.99	32.50	20.43	2.14
1400	26.20	41.86	17.50	24.12	3.06	0.98	32.52	20.27	2.10
1500	26.22	41.51	18.23	22.02	2.94	0.98	32.31	20.24	2.13
1600	26.32	41.00	17.87	20.49	2.74	0.97	31.93	20.09	2.19
1700	26.24	40.37	18.21	19.95	2.58	0.96	31.86	20.10	2.05
1800	26.12	39.51	18.58	19.76	2.39	0.95	31.39	19.66	2.12
1900	26.02	39.18	18.79	19.36	2.34	0.95	31.47	19.67	2.15
2000	25.84	38.81	18.64	18.88	2.28	0.95	31.44	19.74	2.12
2100	25.62	38.44	18.13	19.22	2.24	0.95	31.20	19.63	2.09
2200	25.40	38.11	17.99	18.66	2.22	0.95	30.79	19.22	2.17
2300	25.16	37.90	17.84	18.15	2.22	0.95	30.84	19.39	2.15
2400	24.77	37.71	17.01	18.90	2.26	0.95	31.10	19.35	2.15
2500	24.34	37.99	15.57	19.95	2.42	0.97	30.91	19.52	2.18
2600	24.13	37.22	16.02	18.36	2.28	0.96	31.29	19.51	2.24
2700	23.44	36.79	14.18	21.85	2.33	0.98	31.19	19.24	2.30
2800	23.10	36.55	13.91	20.94	2.35	0.98	31.06	19.38	2.25
2900	22.70	36.01	13.60	20.70	2.31	0.98	31.20	19.35	2.26
3000	21.92	37.05	12.30	26.65	2.78	1.02	31.09	19.31	2.35
3100	21.61	36.07	11.99	23.57	2.57	1.02	30.88	19.11	2.33
3200	21.05	35.99	11.01	24.23	2.67	1.04	30.66	18.94	2.29
3300	20.69	35.17	11.09	23.59	2.54	1.03	31.04	19.23	2.30
3400	20.09	35.53	10.46	25.56	2.78	1.05	31.12	19.08	2.34
3500	19.65	35.46	9.80	24.77	2.85	1.07	30.82	18.87	2.34
3600	19.21	35.14	9.45	24.20	2.86	1.08	30.71	18.82	2.37
3700	18.67	34.94	9.12	25.02	2.94	1.09	30.88	18.65	2.40
3800	18.13	36.27	8.58	24.26	3.54	1.12	31.18	18.75	2.52
3900	17.80	35.52	8.45	23.80	3.37	1.11	30.20	18.59	2.53
4000	17.41	34.67	8.06	23.54	3.16	1.13	29.24	18.36	2.55

## Typical Performance Data

### Definitions:

Input Return Loss = -S11 (dB)

Gain(Power Gain) = S21 (dB)

Reverse Isolation = -S12 (dB)

Output Return Loss = -S22 (dB)

TEST CONDITIONS: Vd = 5V, Id = 100.28 mA @ Temperature = +85degC

FREQ	Gain	Isolation	Input Return Loss	Output Return Loss	Stability		IP-3 Output	1dB Comp. Output	Noise Figure
					K	Measure			
(MHz)	(dB)	(dB)	(dB)	(dB)	K	Measure	(dBm)	(dBm)	(dB)
200	6.57	47.58	3.44	2.74	13.95	0.69	26.40	13.17	7.06
300	15.03	44.10	3.73	5.76	5.70	1.07	31.84	18.45	4.79
400	19.58	44.06	4.79	8.46	4.62	1.16	33.41	19.96	4.02
500	21.97	45.94	6.46	11.20	5.55	1.15	33.88	20.43	4.19
600	23.16	45.67	8.42	13.94	5.44	1.10	33.85	20.55	3.45
700	23.83	46.12	10.24	17.05	5.78	1.07	33.58	20.46	3.32
800	24.22	45.27	11.96	20.75	5.26	1.05	33.36	20.41	3.17
1000	24.67	44.01	14.78	31.61	4.53	1.02	32.99	20.51	3.06
1100	24.78	43.44	15.92	37.36	4.24	1.01	33.35	20.37	3.05
1200	24.86	42.63	16.91	30.78	3.85	1.00	32.84	20.15	3.05
1300	24.92	42.01	17.86	26.14	3.59	0.99	32.72	20.10	3.04
1400	24.91	41.55	18.84	24.26	3.42	0.99	32.21	20.10	3.01
1500	24.88	40.83	19.73	22.38	3.17	0.98	32.23	20.05	3.02
1600	24.89	40.38	19.36	21.15	3.01	0.97	32.08	19.95	3.19
1700	24.78	39.70	19.60	20.59	2.83	0.97	31.97	19.98	3.02
1800	24.63	38.98	19.84	20.28	2.66	0.96	31.40	19.78	3.05
1900	24.47	38.92	20.02	19.22	2.68	0.96	31.52	19.80	3.07
2000	24.26	38.43	19.80	18.63	2.59	0.96	31.57	19.79	3.06
2100	24.00	38.09	19.33	19.22	2.57	0.96	31.42	19.71	3.04
2200	23.75	37.61	18.97	18.82	2.51	0.96	30.92	19.43	3.10
2300	23.47	37.63	18.66	18.67	2.59	0.96	30.83	19.52	3.09
2400	23.12	37.03	17.91	18.92	2.51	0.96	31.01	19.47	3.49
2500	22.75	36.96	16.88	19.30	2.58	0.97	31.09	19.51	3.14
2600	22.39	36.51	16.35	19.31	2.55	0.97	30.83	19.42	3.23
2700	21.90	36.24	15.23	20.48	2.61	0.98	30.55	19.30	3.30
2800	21.54	35.91	14.74	19.98	2.61	0.98	30.50	19.33	3.23
2900	21.15	35.64	14.28	19.80	2.63	0.99	30.82	19.24	3.29
3000	20.60	36.18	13.35	21.30	2.94	1.01	30.79	19.16	3.33
3100	20.15	35.36	12.68	21.69	2.81	1.01	30.46	19.07	3.38
3200	19.65	35.32	11.79	21.53	2.91	1.03	30.23	18.92	3.36
3300	19.25	35.03	11.46	21.14	2.94	1.03	30.53	18.99	3.37
3400	18.81	34.28	11.50	20.85	2.84	1.03	30.60	18.86	3.38
3500	18.32	34.92	10.39	21.67	3.15	1.06	30.46	18.76	3.44
3600	17.87	34.79	9.77	21.86	3.21	1.07	30.19	18.67	3.46
3700	17.43	34.12	9.60	22.23	3.12	1.07	30.42	18.57	3.53
3800	16.90	33.27	9.81	23.44	3.03	1.07	30.35	18.48	3.64
3900	16.62	34.41	8.99	21.82	3.46	1.09	30.21	18.38	3.65
4000	16.20	34.37	8.79	21.37	3.58	1.10	30.23	18.18	3.72

## Typical Performance Data

### Definitions:

Input Return Loss = -S11 (dB)

Gain(Power Gain) = S21 (dB)

Reverse Isolation = -S12 (dB)

Output Return Loss = -S22 (dB)

TEST CONDITIONS: Vd = 3.9V, Id = 97.36 mA @ Temperature = +85degC

FREQ	Gain	Isolation	Input Return Loss	Output Return Loss	Stability		IP-3 Output	1dB Comp. Output	Noise Figure
					K	Measure			
(MHz)	(dB)	(dB)	(dB)	(dB)	K	Measure	(dBm)	(dBm)	(dB)
200	6.39	48.38	3.45	2.77	15.80	0.69	24.36	11.44	7.07
300	14.72	44.42	3.76	5.70	6.15	1.06	28.64	15.87	4.84
400	19.16	44.45	4.88	8.25	5.09	1.15	29.67	17.21	4.05
500	21.44	45.94	6.60	10.79	5.91	1.13	30.23	17.68	4.24
600	22.54	45.73	8.59	13.18	5.87	1.09	30.09	17.84	3.46
700	23.14	45.85	10.39	15.59	6.02	1.06	30.06	17.75	3.33
800	23.48	44.92	12.05	17.97	5.45	1.04	30.03	17.75	3.16
1000	23.84	42.90	14.68	21.94	4.35	1.02	30.31	18.12	3.06
1100	23.92	42.65	15.71	23.05	4.23	1.01	30.21	17.90	3.07
1200	23.96	42.00	16.62	23.46	3.94	1.00	29.68	17.61	3.04
1300	23.99	40.96	17.41	22.99	3.51	0.99	29.78	17.71	3.03
1400	23.95	40.30	18.29	22.40	3.29	0.99	30.02	17.85	3.02
1500	23.89	40.13	19.11	22.01	3.26	0.98	29.66	17.77	3.02
1600	23.89	39.39	18.79	20.55	2.99	0.98	29.68	17.73	3.16
1700	23.76	38.48	19.05	20.49	2.75	0.97	29.67	17.80	3.05
1800	23.61	37.81	19.29	20.45	2.60	0.97	29.50	17.89	3.06
1900	23.45	37.78	19.53	19.77	2.64	0.96	29.61	17.91	3.07
2000	23.25	37.28	19.37	19.16	2.55	0.96	29.47	17.89	3.07
2100	23.00	36.76	18.95	19.68	2.48	0.96	29.35	17.79	3.09
2200	22.78	36.43	18.59	19.58	2.45	0.96	29.29	17.80	3.20
2300	22.52	36.30	18.33	19.52	2.48	0.96	29.13	17.84	3.14
2400	22.21	35.84	17.65	19.93	2.43	0.97	29.44	17.92	3.27
2500	21.88	35.84	16.66	19.64	2.51	0.97	29.23	17.77	3.24
2600	21.55	35.34	16.15	20.32	2.46	0.98	28.95	17.60	3.26
2700	21.10	34.95	15.08	21.85	2.47	0.99	29.17	17.84	3.33
2800	20.77	34.65	14.59	21.85	2.46	0.99	29.00	17.74	3.26
2900	20.43	34.45	14.14	21.68	2.49	0.99	29.28	17.74	3.30
3000	19.93	34.77	13.29	22.50	2.70	1.01	29.07	17.56	3.33
3100	19.51	34.18	12.66	24.15	2.64	1.02	28.94	17.57	3.39
3200	19.05	33.91	11.77	25.29	2.66	1.03	28.83	17.62	3.37
3300	18.67	33.58	11.48	26.07	2.67	1.04	28.85	17.55	3.39
3400	18.26	33.11	11.54	24.75	2.66	1.03	28.94	17.49	3.39
3500	17.80	33.49	10.46	26.94	2.85	1.06	28.74	17.44	3.43
3600	17.39	33.35	9.88	27.12	2.90	1.07	28.59	17.39	3.48
3700	16.97	32.87	9.74	26.50	2.87	1.08	28.86	17.41	3.58
3800	16.48	32.10	9.98	24.68	2.80	1.07	28.86	17.31	3.68
3900	16.20	33.10	9.16	26.69	3.15	1.10	28.68	17.21	3.69
4000	15.80	33.02	8.98	25.88	3.24	1.10	28.45	16.89	3.74

## Typical Performance Data

### Definitions:

Input Return Loss = -S11 (dB)

Gain(Power Gain) = S21 (dB)

Reverse Isolation = -S12 (dB)

Output Return Loss = -S22 (dB)

TEST CONDITIONS: Vd = 5.25V, Id = 100.61 mA @ Temperature = +85degC

FREQ	Gain	Isolation	Input Return Loss	Output Return Loss	Stability		IP-3 Output	1dB Comp. Output	Noise Figure
					K	Measure			
(MHz)	(dB)	(dB)	(dB)	(dB)	K	Measure	(dBm)	(dBm)	(dB)
200	6.59	47.88	3.44	2.74	14.43	0.69	26.64	13.26	7.05
300	15.06	43.65	3.73	5.77	5.38	1.07	32.18	18.84	4.85
400	19.62	43.91	4.79	8.50	4.52	1.17	33.75	20.41	4.04
500	22.02	45.40	6.44	11.24	5.18	1.15	34.38	20.90	4.17
600	23.23	46.13	8.41	14.00	5.70	1.10	34.23	20.99	3.43
700	23.90	45.76	10.23	17.14	5.50	1.07	34.38	20.92	3.32
800	24.31	45.05	11.97	20.86	5.08	1.05	33.72	20.85	3.17
1000	24.76	44.38	14.81	30.31	4.68	1.02	33.57	20.86	3.04
1100	24.89	43.51	15.99	32.19	4.22	1.01	33.28	20.78	3.04
1200	24.97	43.03	17.03	28.22	3.98	1.00	33.13	20.56	3.04
1300	25.03	42.44	17.99	24.88	3.71	0.99	32.89	20.47	3.07
1400	25.03	41.72	18.99	23.29	3.44	0.98	32.53	20.41	3.02
1500	25.00	41.28	19.97	21.62	3.29	0.98	32.44	20.37	3.01
1600	25.02	40.33	19.53	20.60	2.95	0.97	32.14	20.25	3.18
1700	24.90	40.13	19.83	20.06	2.92	0.97	32.15	20.28	3.01
1800	24.75	39.35	20.04	19.73	2.73	0.96	31.81	19.99	3.06
1900	24.59	39.27	20.28	18.76	2.75	0.96	31.56	20.03	3.06
2000	24.39	38.77	20.02	18.21	2.65	0.96	31.55	20.02	3.06
2100	24.11	38.23	19.57	18.80	2.58	0.96	31.53	19.92	3.06
2200	23.86	37.93	19.16	18.41	2.56	0.96	31.02	19.59	3.11
2300	23.58	37.60	18.91	18.26	2.55	0.96	30.84	19.71	3.11
2400	23.23	37.22	18.13	18.50	2.53	0.96	30.90	19.63	3.10
2500	22.85	37.22	17.02	18.98	2.63	0.97	31.17	19.73	3.17
2600	22.48	36.89	16.51	18.95	2.63	0.97	31.05	19.65	3.20
2700	21.98	36.43	15.35	20.01	2.64	0.98	30.88	19.47	3.26
2800	21.61	36.02	14.85	19.53	2.62	0.98	30.65	19.50	3.24
2900	21.22	35.68	14.39	19.34	2.62	0.98	30.83	19.41	3.28
3000	20.66	36.22	13.42	20.87	2.93	1.01	30.88	19.38	3.33
3100	20.20	35.81	12.76	21.13	2.93	1.01	30.58	19.22	3.39
3200	19.70	35.64	11.83	20.92	3.00	1.03	30.39	19.10	3.34
3300	19.29	35.15	11.51	20.53	2.96	1.03	30.72	19.17	3.39
3400	18.84	34.47	11.54	20.28	2.89	1.03	30.66	19.02	3.41
3500	18.35	34.99	10.40	21.03	3.16	1.05	30.50	18.94	3.44
3600	17.90	34.84	9.78	21.16	3.22	1.07	30.32	18.83	3.47
3700	17.45	34.32	9.59	21.61	3.18	1.07	30.43	18.70	3.55
3800	16.91	33.34	9.80	23.02	3.05	1.07	30.48	18.65	3.65
3900	16.62	34.77	8.98	21.22	3.59	1.10	30.54	18.54	3.70
4000	16.20	34.45	8.76	20.79	3.61	1.10	30.22	18.35	3.70

## Typical Performance Data

### Definitions:

Input Return Loss = -S11 (dB)

Gain(Power Gain) = S21 (dB)

Reverse Isolation = -S12 (dB)

Output Return Loss = -S22 (dB)

TEST CONDITIONS: Vd = 2.8V, Id = 92.53 mA @ Temperature = +25degC

FREQ	Gain	Isolation	Input Return Loss	Output Return Loss	Stability		IP-3 Output	1dB Comp. Output	Noise Figure
					K	Measure			
(MHz)	(dB)	(dB)	(dB)	(dB)	K	Measure	(dBm)	(dBm)	(dB)
200	6.04	47.70	3.32	2.79	14.86	0.70	15.77	6.06	6.72
300	14.29	45.58	3.72	5.63	7.34	1.05	22.25	10.42	4.35
400	18.53	45.50	4.97	7.89	6.19	1.12	23.53	11.94	3.61
500	20.57	47.16	6.78	9.88	7.46	1.10	24.42	12.63	4.24
600	21.53	46.21	8.76	11.50	6.84	1.06	24.56	12.96	3.04
700	22.03	44.91	10.46	12.85	5.98	1.04	24.65	13.04	2.94
800	22.30	44.30	11.93	13.79	5.64	1.02	24.80	13.16	2.61
1000	22.55	42.32	13.96	14.86	4.54	1.00	25.28	13.53	2.58
1100	22.60	41.40	14.70	15.13	4.11	0.99	25.10	13.38	2.60
1200	22.62	40.88	15.29	15.33	3.90	0.99	24.76	13.21	2.47
1300	22.60	40.08	15.84	15.41	3.59	0.98	25.03	13.32	2.49
1400	22.57	39.53	16.36	15.39	3.40	0.98	25.36	13.46	2.45
1500	22.50	39.07	16.92	15.47	3.27	0.97	25.17	13.42	2.40
1600	22.49	38.08	16.63	14.95	2.91	0.97	25.12	13.43	2.71
1700	22.36	37.53	17.13	15.29	2.80	0.96	25.14	13.48	2.65
1800	22.22	36.87	17.52	15.45	2.65	0.96	25.31	13.67	2.64
1900	22.09	36.54	17.69	15.39	2.60	0.96	25.49	13.73	2.65
2000	21.93	36.26	17.82	15.42	2.57	0.96	25.35	13.72	2.68
2100	21.73	35.64	17.62	15.69	2.46	0.96	25.32	13.70	2.62
2200	21.54	35.29	17.65	16.00	2.42	0.96	25.40	13.83	2.64
2300	21.36	35.01	17.65	15.88	2.39	0.95	25.49	13.91	2.68
2400	21.07	34.49	17.06	16.46	2.33	0.96	25.60	14.01	2.68
2500	20.74	34.38	15.75	16.26	2.36	0.97	25.44	13.84	2.73
2600	20.59	34.29	16.03	16.13	2.38	0.97	25.33	13.74	2.80
2700	20.07	33.53	14.61	17.93	2.32	0.98	25.94	14.23	2.87
2800	19.84	33.16	14.26	18.21	2.28	0.98	25.81	14.12	2.84
2900	19.54	32.85	13.99	18.23	2.27	0.99	25.90	14.17	2.89
3000	18.90	33.45	12.76	19.58	2.57	1.02	25.82	14.00	2.88
3100	18.67	32.66	12.40	19.92	2.41	1.02	25.84	14.16	2.96
3200	18.25	32.50	11.47	20.68	2.45	1.03	25.79	14.34	2.95
3300	17.97	31.89	11.49	20.90	2.37	1.03	25.79	14.15	2.99
3400	17.32	32.71	10.79	20.00	2.73	1.05	26.12	14.31	3.03
3500	17.17	31.73	10.41	22.32	2.49	1.06	25.93	14.35	3.05
3600	16.75	31.65	10.17	22.15	2.57	1.06	26.01	14.34	3.07
3700	16.30	31.68	9.87	22.73	2.69	1.07	26.45	14.60	3.15
3800	15.76	32.60	9.45	23.38	3.12	1.09	26.36	14.53	3.28
3900	15.55	31.99	9.19	23.14	2.97	1.10	26.20	14.43	3.26
4000	15.24	31.71	8.70	22.35	2.93	1.11	25.84	14.18	3.27

## Typical Performance Data

### Definitions:

Input Return Loss = -S11 (dB)

Gain(Power Gain) = S21 (dB)

Reverse Isolation = -S12 (dB)

Output Return Loss = -S22 (dB)

TEST CONDITIONS: Vd = 2.66V, Id =91.51 mA @ Temperature = +25degC

FREQ	Gain	Isolation	Input Return Loss	Output Return Loss	Stability		IP-3 Output	1dB Comp. Output	Noise Figure
					K	Measure			
(MHz)	(dB)	(dB)	(dB)	(dB)	K	Measure	(dBm)	(dBm)	(dB)
200	5.87	48.63	3.33	2.79	17.00	0.70	14.19	4.82	6.77
300	14.06	45.58	3.77	5.61	7.59	1.05	19.96	9.08	4.43
400	18.24	45.43	5.07	7.84	6.39	1.11	21.74	10.65	3.65
500	20.24	46.77	6.88	9.76	7.44	1.09	22.82	11.32	4.57
600	21.16	46.23	8.83	11.28	7.14	1.05	23.04	11.69	3.12
700	21.65	45.50	10.48	12.52	6.66	1.03	23.23	11.82	3.03
800	21.91	44.41	11.87	13.37	5.94	1.02	23.39	11.94	2.80
1000	22.14	42.46	13.77	14.31	4.80	1.00	23.90	12.33	2.68
1100	22.18	41.49	14.46	14.55	4.32	0.99	23.87	12.22	2.71
1200	22.19	40.48	15.00	14.74	3.88	0.99	23.51	12.08	2.67
1300	22.17	40.16	15.50	14.82	3.77	0.98	23.82	12.19	2.68
1400	22.14	39.12	15.99	14.84	3.38	0.98	24.14	12.31	2.65
1500	22.07	38.81	16.50	14.94	3.31	0.97	23.92	12.26	2.64
1600	22.05	38.17	16.29	14.50	3.07	0.97	23.96	12.31	2.75
1700	21.92	37.20	16.74	14.82	2.82	0.96	23.98	12.37	2.65
1800	21.78	36.78	17.16	15.01	2.74	0.96	24.17	12.54	2.67
1900	21.65	36.23	17.39	14.97	2.62	0.96	24.31	12.63	2.67
2000	21.49	35.83	17.59	15.02	2.56	0.95	24.20	12.62	2.72
2100	21.30	35.43	17.43	15.32	2.50	0.96	24.22	12.63	2.73
2200	21.11	34.77	17.53	15.64	2.39	0.95	24.30	12.74	2.71
2300	20.93	34.83	17.50	15.56	2.45	0.96	24.42	12.84	2.75
2400	20.66	34.37	16.97	16.09	2.40	0.96	24.58	12.93	2.74
2500	20.33	34.22	15.74	15.92	2.42	0.97	24.43	12.82	2.77
2600	20.19	34.18	15.97	15.87	2.46	0.97	24.32	12.76	2.84
2700	19.68	33.32	14.61	17.47	2.36	0.98	24.91	13.21	2.90
2800	19.45	32.97	14.29	17.78	2.33	0.99	24.81	13.18	2.87
2900	19.16	32.73	13.99	17.83	2.33	0.99	24.95	13.19	2.91
3000	18.55	33.19	12.74	19.01	2.59	1.02	24.87	13.09	2.92
3100	18.32	32.47	12.38	19.37	2.45	1.02	24.88	13.23	2.98
3200	17.91	32.36	11.46	20.09	2.50	1.03	24.90	13.46	3.02
3300	17.62	31.64	11.48	20.28	2.39	1.03	24.89	13.31	3.01
3400	17.00	32.40	10.75	19.44	2.72	1.05	25.26	13.45	3.06
3500	16.85	31.52	10.40	21.52	2.51	1.06	25.10	13.50	3.06
3600	16.43	31.34	10.13	21.40	2.56	1.06	25.10	13.49	3.12
3700	15.99	31.65	9.82	21.90	2.76	1.08	25.56	13.84	3.16
3800	15.46	32.26	9.38	22.45	3.09	1.09	25.52	13.73	3.29
3900	15.26	31.59	9.13	22.26	2.93	1.10	25.35	13.64	3.26
4000	14.95	31.33	8.64	21.61	2.89	1.11	25.13	13.44	3.29



## Typical Performance Data

### Definitions:

Input Return Loss = -S11 (dB)

Gain(Power Gain) = S21 (dB)

Reverse Isolation = -S12 (dB)

Output Return Loss = -S22 (dB)

TEST CONDITIONS: Vd = 3V, Id = 93.43 mA @ Temperature = +25degC

FREQ	Gain	Isolation	Input Return Loss	Output Return Loss	Stability		IP-3 Output	1dB Comp. Output	Noise Figure
					K	Measure			
(MHz)	(dB)	(dB)	(dB)	(dB)	K	Measure	(dBm)	(dBm)	(dB)
200	6.22	48.06	3.31	2.78	15.12	0.70	18.50	7.67	6.64
300	14.53	44.91	3.67	5.66	6.53	1.06	24.33	11.89	4.39
400	18.84	45.15	4.88	7.98	5.67	1.13	25.37	13.40	3.59
500	20.94	46.71	6.66	10.05	6.76	1.11	26.06	13.98	4.52
600	21.93	46.29	8.66	11.80	6.60	1.07	26.16	14.28	3.07
700	22.46	45.15	10.40	13.35	5.88	1.04	26.14	14.32	3.00
800	22.74	44.38	11.93	14.45	5.44	1.03	26.27	14.36	2.74
1000	23.02	42.46	14.09	15.79	4.41	1.01	26.53	14.76	2.63
1100	23.08	41.56	14.89	16.08	4.00	1.00	26.49	14.57	2.65
1200	23.10	40.91	15.54	16.32	3.73	0.99	26.11	14.37	2.65
1300	23.10	40.17	16.13	16.40	3.45	0.99	26.37	14.48	2.57
1400	23.07	39.49	16.68	16.33	3.22	0.98	26.62	14.62	2.59
1500	23.01	39.01	17.27	16.37	3.09	0.97	26.34	14.56	2.57
1600	23.01	38.43	16.96	15.76	2.88	0.97	26.35	14.57	2.72
1700	22.88	37.71	17.39	16.10	2.72	0.97	26.36	14.61	2.61
1800	22.74	37.00	17.82	16.23	2.56	0.96	26.48	14.82	2.62
1900	22.60	36.41	17.98	16.13	2.44	0.96	26.59	14.87	2.61
2000	22.44	36.33	18.03	16.09	2.46	0.96	26.50	14.84	2.59
2100	22.24	35.74	17.70	16.37	2.36	0.96	26.38	14.79	2.63
2200	22.04	35.43	17.69	16.69	2.34	0.96	26.45	14.93	2.61
2300	21.85	35.11	17.69	16.52	2.30	0.95	26.51	14.96	2.66
2400	21.56	34.84	17.02	17.14	2.31	0.96	26.63	15.08	2.66
2500	21.21	34.58	15.67	16.93	2.31	0.97	26.46	14.91	2.73
2600	21.06	34.45	15.98	16.69	2.31	0.97	26.32	14.81	2.77
2700	20.52	33.87	14.51	18.80	2.30	0.98	26.97	15.27	2.86
2800	20.28	33.35	14.20	19.03	2.23	0.98	26.73	15.15	2.82
2900	19.97	33.07	13.94	18.99	2.23	0.99	26.88	15.19	2.86
3000	19.32	33.71	12.69	20.62	2.53	1.02	26.77	14.99	2.87
3100	19.08	32.93	12.36	20.98	2.38	1.02	26.78	15.13	2.95
3200	18.65	32.88	11.43	21.82	2.45	1.03	26.72	15.30	2.93
3300	18.35	32.17	11.46	22.10	2.35	1.03	26.68	15.11	2.97
3400	17.69	32.84	10.76	21.02	2.66	1.05	26.98	15.24	3.03
3500	17.54	32.18	10.41	23.75	2.52	1.06	26.90	15.26	3.01
3600	17.11	31.91	10.15	23.54	2.55	1.06	26.86	15.19	3.05
3700	16.65	32.11	9.84	24.27	2.72	1.08	27.34	15.51	3.10
3800	16.10	32.83	9.44	24.90	3.09	1.09	27.19	15.43	3.24
3900	15.89	32.22	9.19	24.64	2.94	1.10	26.94	15.29	3.24
4000	15.57	32.11	8.71	23.64	2.96	1.11	26.52	15.04	3.28

## Typical Performance Data

### Definitions:

Input Return Loss = -S11 (dB)

Gain(Power Gain) = S21 (dB)

Reverse Isolation = -S12 (dB)

Output Return Loss = -S22 (dB)

TEST CONDITIONS: Vd = 2.8V, Id = 89.86 mA @ Temperature = -45degC

FREQ	Gain	Isolation	Input Return Loss	Output Return Loss	Stability		IP-3 Output	1dB Comp. Output	Noise Figure
					K	Measure			
(MHz)	(dB)	(dB)	(dB)	(dB)	K	Measure	(dBm)	(dBm)	(dB)
200	6.33	47.70	3.19	2.75	13.84	0.70	17.87	7.27	5.97
300	14.86	44.92	3.60	5.82	6.30	1.08	23.87	11.34	3.78
400	19.20	44.76	4.82	8.22	5.21	1.15	24.99	12.72	3.08
500	21.35	46.60	6.50	10.60	6.38	1.13	25.85	13.24	3.96
600	22.36	46.31	8.44	12.79	6.34	1.09	25.95	13.45	2.60
700	22.94	45.74	10.12	15.13	6.02	1.07	25.90	13.43	2.57
800	23.27	45.41	11.58	17.39	5.84	1.05	26.08	13.45	2.31
1000	23.61	43.36	13.80	21.01	4.65	1.03	26.99	13.98	2.20
1100	23.69	42.24	14.55	22.12	4.10	1.02	26.54	13.70	2.21
1200	23.74	41.75	15.14	23.06	3.89	1.01	26.11	13.43	2.17
1300	23.75	41.21	15.60	23.40	3.67	1.01	26.47	13.57	2.18
1400	23.74	40.27	15.92	22.90	3.32	1.00	26.88	13.79	2.14
1500	23.69	40.03	16.33	22.30	3.25	1.00	26.55	13.67	2.18
1600	23.72	39.09	16.05	20.77	2.92	0.99	26.65	13.71	2.21
1700	23.63	38.40	16.43	21.11	2.74	0.98	26.59	13.73	2.14
1800	23.50	37.74	16.78	21.17	2.60	0.98	27.02	14.05	2.17
1900	23.39	37.47	17.00	20.65	2.55	0.97	27.13	14.07	2.17
2000	23.24	37.04	17.17	20.06	2.48	0.97	26.91	14.01	2.17
2100	23.07	36.46	16.93	20.22	2.37	0.97	26.77	13.99	2.18
2200	22.89	36.17	16.87	19.98	2.34	0.97	27.12	14.24	2.22
2300	22.72	35.94	16.82	19.29	2.32	0.96	27.09	14.23	2.22
2400	22.42	35.65	16.21	19.88	2.32	0.97	27.26	14.28	2.34
2500	22.12	35.39	15.08	19.77	2.31	0.98	26.76	14.09	2.22
2600	21.97	35.11	15.29	19.19	2.28	0.97	26.36	13.91	2.29
2700	21.44	34.55	13.91	22.69	2.26	0.99	27.00	14.52	2.36
2800	21.21	34.16	13.63	22.19	2.22	0.99	26.91	14.43	2.33
2900	20.91	33.82	13.31	22.06	2.20	0.99	27.10	14.44	2.35
3000	20.25	34.58	12.57	27.16	2.54	1.02	26.79	14.23	2.38
3100	20.03	33.69	12.15	25.94	2.36	1.02	26.80	14.43	2.38
3200	19.59	33.64	11.01	26.87	2.41	1.04	26.93	14.73	2.36
3300	19.19	33.38	11.03	27.16	2.45	1.04	26.39	14.37	2.37
3400	18.77	33.26	10.51	28.74	2.51	1.05	26.56	14.49	2.41
3500	18.45	33.00	10.12	29.84	2.50	1.06	26.57	14.67	2.43
3600	18.06	32.66	9.92	29.29	2.51	1.06	26.41	14.65	2.44
3700	17.58	32.73	9.75	31.72	2.65	1.07	27.03	15.08	2.51
3800	17.06	33.58	9.46	37.37	3.05	1.09	26.85	14.92	2.60
3900	16.82	32.96	9.09	27.31	2.90	1.09	26.51	14.79	2.62
4000	16.46	32.35	8.65	24.72	2.77	1.10	26.34	14.61	2.64

## Typical Performance Data

### Definitions:

Input Return Loss = -S11 (dB)

Gain(Power Gain) = S21 (dB)

Reverse Isolation = -S12 (dB)

Output Return Loss = -S22 (dB)

TEST CONDITIONS: Vd = 2.66V, Id = 89.65 mA @ Temperature = -45degC

FREQ	Gain	Isolation	Input Return Loss	Output Return Loss	Stability		IP-3 Output	1dB Comp. Output	Noise Figure
					K	Measure			
(MHz)	(dB)	(dB)	(dB)	(dB)			(dBm)	(dBm)	(dB)
200	6.18	47.33	3.20	2.76	13.53	0.70	16.18	6.03	6.03
300	14.64	45.60	3.66	5.80	7.08	1.07	22.40	10.20	3.77
400	18.92	44.57	4.92	8.18	5.32	1.14	23.62	11.64	3.13
500	21.01	47.34	6.61	10.50	7.27	1.12	24.47	12.22	4.02
600	21.99	46.72	8.51	12.59	6.93	1.08	24.63	12.47	2.62
700	22.55	46.30	10.14	14.75	6.70	1.06	24.64	12.52	2.60
800	22.86	45.34	11.53	16.75	6.05	1.05	24.75	12.56	2.32
1000	23.18	43.44	13.57	19.72	4.90	1.03	25.69	13.06	2.22
1100	23.25	42.43	14.26	20.54	4.38	1.02	25.36	12.82	2.24
1200	23.29	41.59	14.81	21.26	4.00	1.01	24.87	12.58	2.23
1300	23.30	40.88	15.21	21.60	3.70	1.01	25.29	12.72	2.20
1400	23.28	40.23	15.48	21.32	3.46	1.00	25.81	12.91	2.16
1500	23.22	39.74	15.86	21.00	3.30	1.00	25.45	12.82	2.18
1600	23.23	38.84	15.59	19.86	2.98	0.99	25.46	12.86	2.23
1700	23.14	38.32	15.97	20.25	2.85	0.99	25.48	12.87	2.12
1800	23.01	37.65	16.31	20.43	2.70	0.98	25.88	13.15	2.18
1900	22.90	37.11	16.55	20.02	2.58	0.98	25.97	13.20	2.20
2000	22.75	36.88	16.73	19.58	2.56	0.97	25.81	13.15	2.20
2100	22.58	36.39	16.57	19.78	2.47	0.97	25.71	13.13	2.19
2200	22.41	35.86	16.55	19.63	2.38	0.97	26.04	13.36	2.23
2300	22.24	35.60	16.50	19.07	2.35	0.97	26.04	13.37	2.23
2400	21.95	35.50	15.93	19.68	2.39	0.97	26.19	13.46	2.27
2500	21.66	35.33	14.89	19.47	2.40	0.98	25.71	13.24	2.24
2600	21.52	34.79	15.13	19.19	2.31	0.97	25.56	13.09	2.30
2700	21.01	34.37	13.80	22.31	2.31	0.99	26.33	13.73	2.36
2800	20.78	33.92	13.48	21.94	2.26	0.99	26.34	13.68	2.36
2900	20.50	33.55	13.14	22.03	2.23	1.00	26.41	13.68	2.39
3000	19.85	34.32	12.38	26.38	2.57	1.02	26.13	13.44	2.40
3100	19.65	33.48	11.87	25.71	2.39	1.02	26.26	13.72	2.41
3200	19.22	33.24	10.90	26.14	2.40	1.04	26.37	13.97	2.37
3300	18.90	32.74	11.09	25.62	2.36	1.03	25.99	13.67	2.40
3400	18.42	33.02	10.44	27.54	2.53	1.05	26.23	13.74	2.43
3500	18.10	32.81	10.00	28.77	2.53	1.06	26.39	13.96	2.46
3600	17.73	32.33	9.75	28.45	2.49	1.07	26.34	13.95	2.49
3700	17.26	32.70	9.58	30.35	2.72	1.08	27.07	14.35	2.58
3800	16.75	33.56	9.21	35.51	3.12	1.10	26.82	14.23	2.66
3900	16.51	32.76	8.95	26.18	2.91	1.10	26.72	14.11	2.61
4000	16.19	31.88	8.57	23.36	2.71	1.10	26.31	13.88	2.66

## Typical Performance Data

### Definitions:

Input Return Loss = -S11 (dB)

Gain(Power Gain) = S21 (dB)

Reverse Isolation = -S12 (dB)

Output Return Loss = -S22 (dB)

TEST CONDITIONS: Vd = 3V, Id = 90.45 mA @ Temperature = -45degC

FREQ	Gain	Isolation	Input Return Loss	Output Return Loss	Stability		IP-3 Output	1dB Comp. Output	Noise Figure
					K	Measure			
(MHz)	(dB)	(dB)	(dB)	(dB)	K	Measure	(dBm)	(dBm)	(dB)
200	6.48	48.10	3.18	2.74	14.18	0.70	20.69	8.65	5.93
300	15.07	44.31	3.56	5.84	5.67	1.09	25.89	12.76	3.66
400	19.47	44.79	4.73	8.29	5.02	1.16	26.83	14.11	3.06
500	21.68	46.37	6.38	10.73	5.94	1.14	27.62	14.60	3.89
600	22.72	46.78	8.35	13.03	6.41	1.10	27.70	14.79	2.57
700	23.33	46.40	10.04	15.57	6.22	1.07	27.69	14.73	2.53
800	23.68	45.32	11.57	18.22	5.54	1.05	27.80	14.74	2.30
1000	24.04	43.71	13.90	22.99	4.63	1.03	28.75	15.28	2.19
1100	24.13	42.35	14.71	24.79	3.97	1.02	28.30	14.96	2.17
1200	24.20	41.85	15.34	26.39	3.76	1.01	27.74	14.71	2.22
1300	24.22	41.26	15.85	26.76	3.52	1.01	28.04	14.85	2.16
1400	24.22	40.61	16.18	25.60	3.28	1.00	28.50	15.06	2.12
1500	24.18	40.02	16.62	24.20	3.10	0.99	28.19	14.96	2.14
1600	24.21	39.53	16.32	22.09	2.91	0.99	28.20	14.98	2.28
1700	24.12	38.63	16.69	22.19	2.68	0.98	28.23	15.04	2.13
1800	24.00	38.10	17.06	22.12	2.57	0.98	28.56	15.34	2.17
1900	23.89	37.70	17.25	21.45	2.49	0.97	28.65	15.36	2.16
2000	23.73	37.58	17.33	20.72	2.50	0.97	28.46	15.29	2.16
2100	23.56	36.55	17.05	20.84	2.28	0.96	28.18	15.25	2.15
2200	23.39	36.40	16.97	20.35	2.28	0.96	28.47	15.48	2.20
2300	23.21	35.98	16.97	19.53	2.22	0.96	28.40	15.49	2.20
2400	22.89	36.01	16.26	20.27	2.30	0.97	28.62	15.58	2.10
2500	22.58	35.61	15.10	20.29	2.25	0.98	28.16	15.36	2.21
2600	22.43	35.36	15.45	19.45	2.24	0.97	27.64	15.22	2.28
2700	21.87	34.67	13.94	23.27	2.19	0.99	28.29	15.76	2.35
2800	21.62	34.32	13.66	22.46	2.16	0.99	28.28	15.67	2.30
2900	21.32	34.00	13.38	22.29	2.15	0.99	28.47	15.66	2.32
3000	20.60	35.07	12.50	29.12	2.58	1.02	28.14	15.40	2.40
3100	20.39	33.99	12.10	27.03	2.34	1.02	28.12	15.63	2.37
3200	19.95	33.85	11.08	27.33	2.38	1.03	28.31	15.85	2.35
3300	19.62	33.23	11.34	26.77	2.32	1.03	27.75	15.53	2.34
3400	19.11	33.47	10.62	29.66	2.48	1.05	27.93	15.57	2.38
3500	18.75	33.18	10.23	30.57	2.48	1.06	27.88	15.77	2.41
3600	18.36	32.91	9.98	30.12	2.50	1.06	27.69	15.69	2.46
3700	17.86	33.05	9.81	33.02	2.67	1.07	28.29	16.05	2.52
3800	17.33	34.19	9.36	33.04	3.16	1.09	28.13	15.83	2.56
3900	17.09	33.45	9.10	28.22	2.97	1.09	27.98	15.77	2.59
4000	16.78	32.72	8.67	25.30	2.79	1.10	27.80	15.57	2.62

## Typical Performance Data

### Definitions:

Input Return Loss = -S11 (dB)

Gain(Power Gain) = S21 (dB)

Reverse Isolation = -S12 (dB)

Output Return Loss = -S22 (dB)

TEST CONDITIONS: Vd = 2.8V, Id = 92.95mA @ Temperature = +85degC

FREQ	Gain	Isolation	Input Return Loss	Output Return Loss	Stability		IP-3 Output	1dB Comp. Output	Noise Figure
					K	Measure			
(MHz)	(dB)	(dB)	(dB)	(dB)	K	Measure	(dBm)	(dBm)	(dB)
200	5.73	48.71	3.48	2.80	18.01	0.70	14.81	5.27	7.31
300	13.80	45.43	3.91	5.59	7.87	1.04	21.22	9.50	5.00
400	17.96	45.35	5.17	7.88	6.63	1.11	22.86	11.08	4.19
500	20.02	46.72	6.99	10.01	7.68	1.09	23.82	11.79	4.39
600	20.97	46.31	8.92	11.67	7.45	1.06	24.05	12.15	3.53
700	21.46	45.43	10.57	13.03	6.82	1.04	24.22	12.27	3.43
800	21.72	44.47	11.99	14.05	6.16	1.02	24.34	12.39	3.23
1000	21.97	42.45	14.06	15.31	4.95	1.00	24.83	12.80	3.11
1100	22.01	41.56	14.87	15.61	4.50	1.00	24.72	12.66	3.12
1200	22.02	40.95	15.52	15.83	4.22	0.99	24.42	12.49	3.11
1300	22.01	39.99	16.08	15.91	3.82	0.99	24.64	12.62	3.12
1400	21.95	39.11	16.76	15.93	3.50	0.98	24.98	12.78	3.09
1500	21.87	38.80	17.42	16.10	3.43	0.98	24.77	12.72	3.09
1600	21.83	38.24	17.37	15.66	3.22	0.97	24.79	12.77	3.23
1700	21.71	37.41	17.76	15.80	2.99	0.97	24.82	12.81	3.10
1800	21.56	36.82	18.14	15.97	2.86	0.96	24.94	12.99	3.15
1900	21.40	36.57	18.55	15.91	2.83	0.96	25.04	13.04	3.14
2000	21.23	36.17	18.82	15.72	2.76	0.96	25.03	13.06	3.17
2100	21.00	35.53	18.70	16.05	2.64	0.96	24.98	13.03	3.19
2200	20.80	35.01	18.58	16.21	2.55	0.96	25.00	13.14	3.22
2300	20.58	34.83	18.42	16.33	2.57	0.96	25.14	13.23	3.22
2400	20.32	34.41	18.08	16.62	2.52	0.96	25.34	13.38	3.15
2500	20.03	34.40	17.26	16.28	2.58	0.96	25.17	13.20	3.24
2600	19.74	33.91	16.76	16.94	2.53	0.97	25.09	13.16	3.30
2700	19.35	33.59	15.72	17.78	2.55	0.98	25.45	13.55	3.38
2800	19.06	33.19	15.19	18.21	2.51	0.98	25.47	13.54	3.34
2900	18.76	32.83	14.67	18.37	2.49	0.99	25.70	13.62	3.35
3000	18.32	33.06	13.75	18.46	2.65	1.00	25.54	13.44	3.44
3100	17.94	32.72	13.13	19.54	2.65	1.01	25.49	13.56	3.49
3200	17.55	32.44	12.26	20.64	2.66	1.02	25.49	13.79	3.44
3300	17.19	32.10	11.94	21.57	2.66	1.03	25.54	13.64	3.50
3400	16.79	31.79	11.89	21.39	2.69	1.03	25.73	13.72	3.51
3500	16.40	31.98	10.85	22.19	2.81	1.05	25.63	13.77	3.56
3600	16.02	31.75	10.26	22.31	2.82	1.07	25.65	13.82	3.61
3700	15.62	31.32	10.13	21.65	2.80	1.07	25.99	14.08	3.67
3800	15.15	30.75	10.27	20.12	2.78	1.06	25.88	14.01	3.80
3900	14.90	31.60	9.52	22.64	3.09	1.09	25.82	13.91	3.83
4000	14.51	31.57	9.28	22.52	3.20	1.09	25.58	13.58	3.86

## Typical Performance Data

### Definitions:

Input Return Loss = -S11 (dB)

Gain(Power Gain) = S21 (dB)

Reverse Isolation = -S12 (dB)

Output Return Loss = -S22 (dB)

TEST CONDITIONS: Vd = 2.66V, Id = 92.34 mA @ Temperature = +85degC

FREQ	Gain	Isolation	Input Return Loss	Output Return Loss	Stability		IP-3 Output	1dB Comp. Output	Noise Figure
					K	Measure			
(MHz)	(dB)	(dB)	(dB)	(dB)	K	Measure	(dBm)	(dBm)	(dB)
200	5.52	48.93	3.50	2.80	19.00	0.69	13.45	3.62	7.41
300	13.53	45.20	3.97	5.57	7.98	1.03	18.56	8.00	5.04
400	17.61	45.74	5.27	7.81	7.29	1.10	20.58	9.55	4.21
500	19.61	46.57	7.09	9.88	7.94	1.08	21.84	10.36	4.45
600	20.54	45.52	8.96	11.44	7.14	1.05	22.25	10.72	3.56
700	21.00	45.24	10.53	12.68	6.99	1.03	22.46	10.87	3.47
800	21.25	44.02	11.83	13.59	6.13	1.02	22.70	11.00	3.27
1000	21.49	42.53	13.68	14.72	5.23	1.00	23.33	11.43	3.14
1100	21.52	41.41	14.39	15.00	4.64	1.00	23.27	11.30	3.16
1200	21.52	40.55	14.98	15.23	4.24	0.99	22.92	11.19	3.14
1300	21.50	40.00	15.43	15.32	4.01	0.99	23.19	11.32	3.11
1400	21.44	39.15	16.06	15.37	3.69	0.98	23.58	11.45	3.10
1500	21.36	38.74	16.68	15.55	3.57	0.98	23.39	11.43	3.11
1600	21.32	37.88	16.66	15.22	3.26	0.97	23.34	11.46	3.28
1700	21.20	37.29	17.04	15.37	3.10	0.97	23.45	11.53	3.12
1800	21.05	36.77	17.44	15.53	2.99	0.97	23.58	11.72	3.13
1900	20.90	36.33	17.89	15.51	2.90	0.96	23.70	11.77	3.17
2000	20.73	35.98	18.19	15.38	2.84	0.96	23.71	11.83	3.19
2100	20.51	35.40	18.17	15.68	2.74	0.96	23.68	11.79	3.20
2200	20.32	34.81	18.13	15.83	2.63	0.96	23.79	11.92	3.22
2300	20.10	34.51	18.05	16.02	2.61	0.96	23.91	11.99	3.22
2400	19.84	34.31	17.80	16.29	2.62	0.96	24.09	12.13	3.39
2500	19.56	34.21	17.04	16.02	2.66	0.97	24.01	12.07	3.27
2600	19.28	33.68	16.60	16.61	2.59	0.97	23.97	12.01	3.31
2700	18.90	33.27	15.63	17.39	2.57	0.98	24.32	12.41	3.40
2800	18.63	33.04	15.07	17.83	2.58	0.98	24.36	12.43	3.39
2900	18.34	32.64	14.58	17.97	2.54	0.99	24.56	12.51	3.43
3000	17.91	32.92	13.67	18.13	2.72	1.00	24.50	12.38	3.45
3100	17.54	32.42	13.04	19.12	2.67	1.01	24.47	12.49	3.52
3200	17.15	32.28	12.19	20.12	2.72	1.03	24.45	12.74	3.47
3300	16.81	31.89	11.87	20.97	2.70	1.03	24.52	12.66	3.53
3400	16.42	31.57	11.78	20.81	2.72	1.03	24.74	12.75	3.52
3500	16.03	31.62	10.76	21.51	2.80	1.05	24.73	12.83	3.59
3600	15.66	31.55	10.19	21.56	2.86	1.07	24.77	12.84	3.66
3700	15.27	31.02	10.04	20.96	2.81	1.07	25.06	13.15	3.72
3800	14.81	30.52	10.15	19.61	2.80	1.06	25.01	13.10	3.83
3900	14.56	31.33	9.43	21.81	3.10	1.09	24.95	12.98	3.85
4000	14.18	31.36	9.18	21.63	3.22	1.09	24.69	12.75	3.89

## Typical Performance Data

### Definitions:

Input Return Loss = -S11 (dB)

Gain(Power Gain) = S21 (dB)

Reverse Isolation = -S12 (dB)

Output Return Loss = -S22 (dB)

TEST CONDITIONS: Vd = 3V, Id = 93.82 mA @ Temperature = +85degC

FREQ	Gain	Isolation	Input Return Loss	Output Return Loss	Stability		IP-3 Output	1dB Comp. Output	Noise Figure
					K	Measure			
(MHz)	(dB)	(dB)	(dB)	(dB)	K	Measure	(dBm)	(dBm)	(dB)
200	5.94	47.73	3.46	2.80	15.58	0.70	17.35	6.97	7.24
300	14.09	45.21	3.84	5.62	7.35	1.04	23.77	11.26	4.92
400	18.32	45.18	5.06	7.97	6.19	1.12	25.05	12.77	4.14
500	20.44	46.42	6.87	10.18	7.04	1.10	25.85	13.45	4.32
600	21.43	46.39	8.83	11.98	7.15	1.07	25.94	13.73	3.51
700	21.94	45.25	10.55	13.51	6.35	1.04	25.93	13.80	3.39
800	22.22	44.22	12.07	14.72	5.70	1.03	25.99	13.85	3.22
1000	22.49	42.56	14.35	16.19	4.76	1.01	26.40	14.30	3.09
1100	22.54	41.53	15.24	16.55	4.26	1.00	26.36	14.10	3.10
1200	22.56	40.86	15.98	16.81	3.97	0.99	26.01	13.88	3.09
1300	22.55	40.33	16.58	16.86	3.76	0.99	26.17	14.02	3.09
1400	22.49	39.22	17.36	16.84	3.36	0.98	26.47	14.18	3.07
1500	22.42	39.05	18.08	16.95	3.34	0.98	26.20	14.10	3.08
1600	22.39	38.23	17.97	16.42	3.05	0.97	26.18	14.13	3.19
1700	22.26	37.46	18.35	16.57	2.85	0.97	26.20	14.18	3.08
1800	22.11	36.99	18.71	16.68	2.76	0.96	26.33	14.38	3.09
1900	21.95	36.69	19.12	16.57	2.72	0.96	26.38	14.42	3.12
2000	21.77	36.21	19.23	16.31	2.63	0.96	26.37	14.41	3.14
2100	21.54	35.82	19.00	16.65	2.58	0.96	26.29	14.35	3.14
2200	21.34	35.46	18.81	16.77	2.54	0.96	26.35	14.47	3.19
2300	21.11	35.12	18.61	16.90	2.51	0.96	26.34	14.54	3.18
2400	20.83	34.65	18.16	17.22	2.46	0.96	26.48	14.65	3.14
2500	20.53	34.62	17.28	16.84	2.51	0.96	26.37	14.50	3.25
2600	20.23	34.06	16.75	17.52	2.45	0.97	26.26	14.34	3.28
2700	19.82	33.74	15.68	18.48	2.46	0.98	26.62	14.79	3.36
2800	19.53	33.43	15.12	18.88	2.46	0.98	26.58	14.76	3.30
2900	19.22	32.98	14.63	19.04	2.41	0.99	26.79	14.79	3.37
3000	18.76	33.42	13.73	19.18	2.63	1.00	26.56	14.59	3.40
3100	18.37	33.01	13.12	20.38	2.62	1.01	26.55	14.73	3.45
3200	17.96	32.63	12.25	21.56	2.60	1.02	26.46	14.89	3.44
3300	17.60	32.38	11.93	22.66	2.63	1.03	26.48	14.69	3.47
3400	17.19	32.07	11.91	22.33	2.66	1.03	26.69	14.82	3.49
3500	16.79	32.30	10.85	23.35	2.80	1.05	26.62	14.83	3.53
3600	16.40	32.12	10.26	23.45	2.82	1.07	26.56	14.84	3.57
3700	16.00	31.68	10.15	22.69	2.80	1.07	26.94	15.06	3.65
3800	15.52	31.03	10.33	20.90	2.76	1.06	26.87	15.01	3.77
3900	15.26	31.90	9.54	23.82	3.07	1.09	26.73	14.91	3.77
4000	14.87	32.01	9.32	23.69	3.23	1.09	26.36	14.58	3.81

## Typical Performance Curves

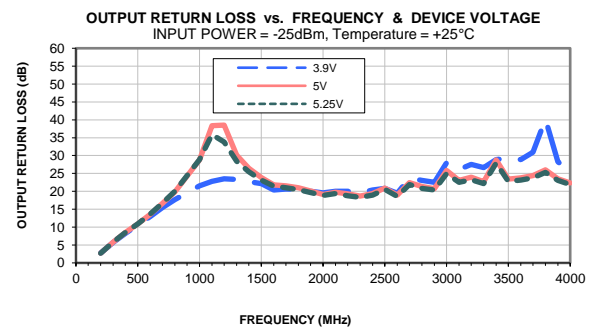
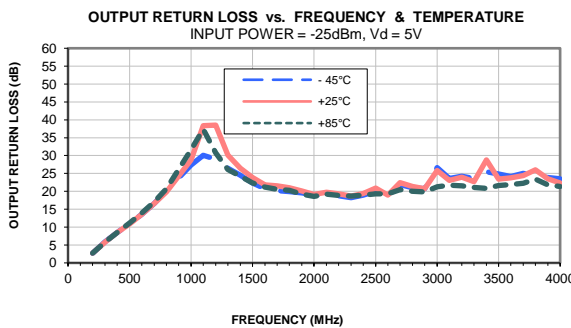
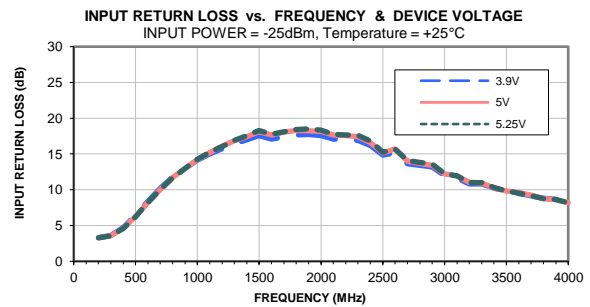
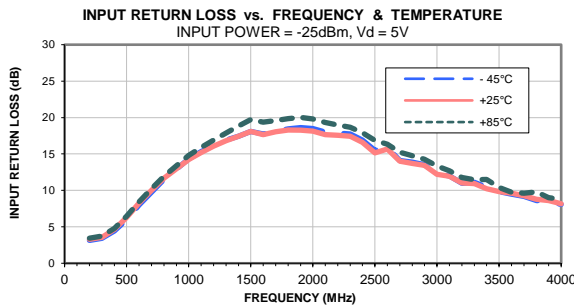
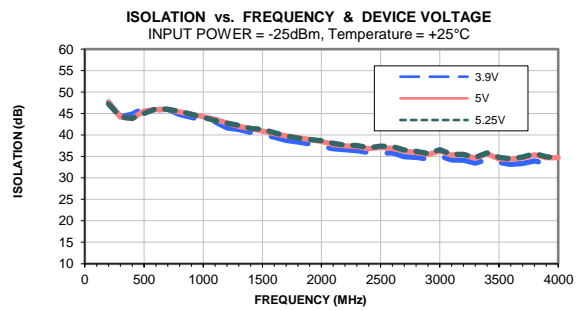
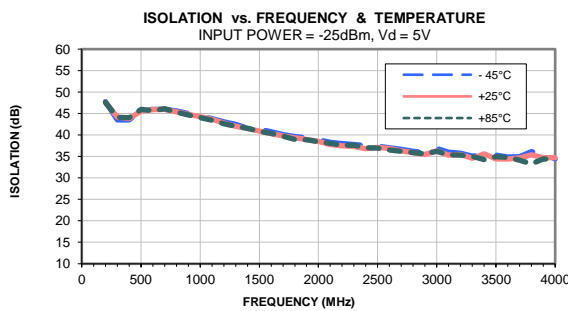
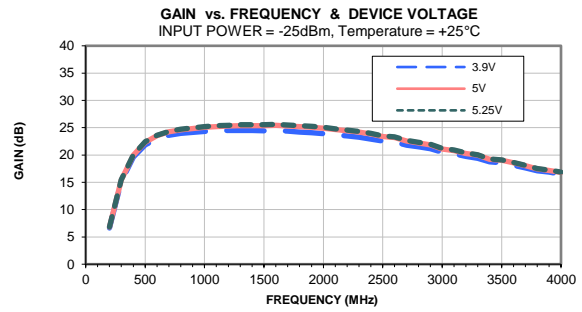
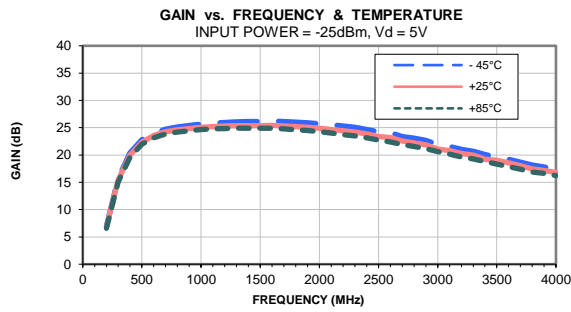



## Typical Performance Curves

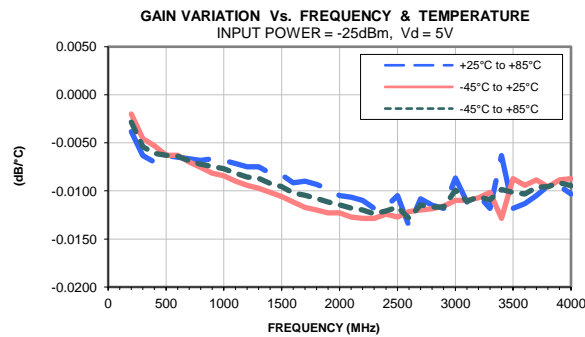
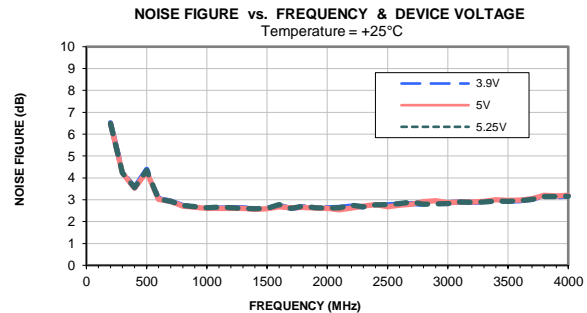
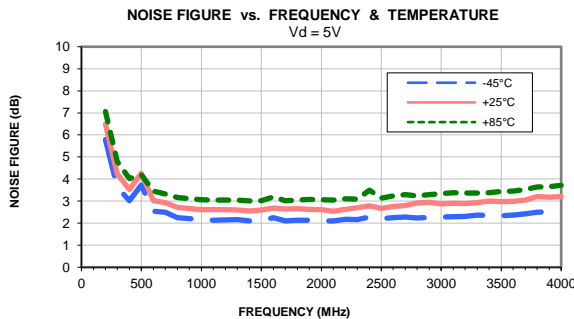
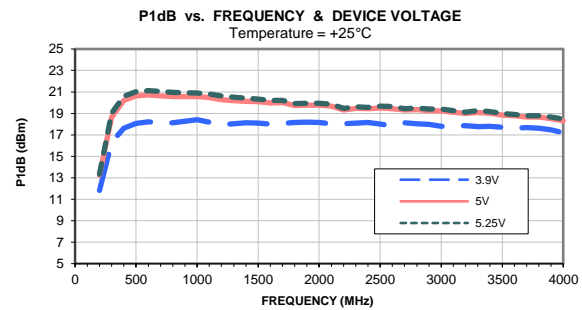
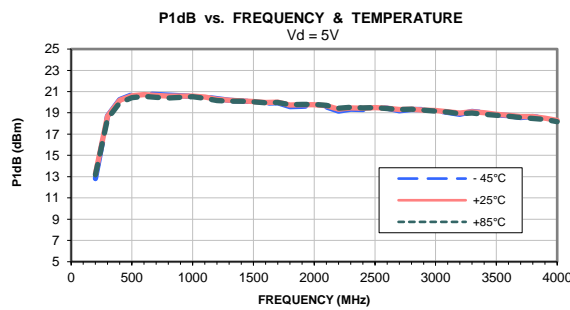
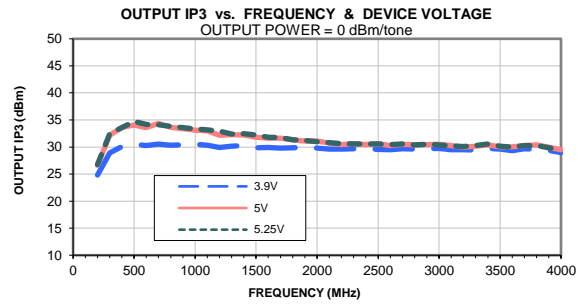
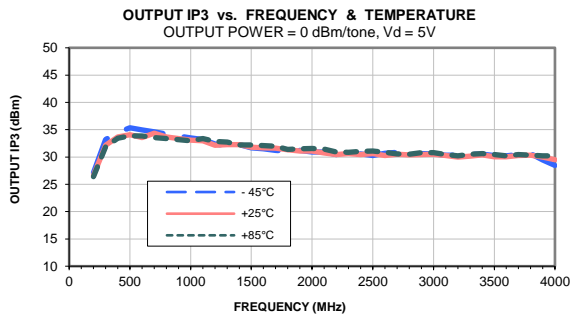

## Typical Performance Curves

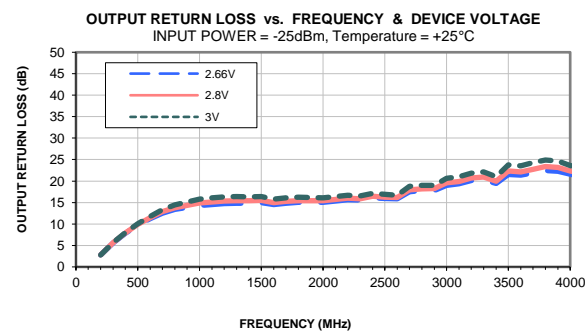
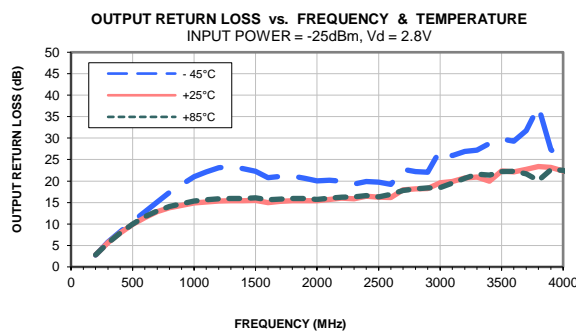
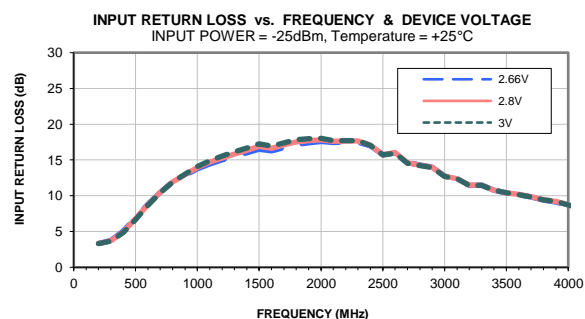
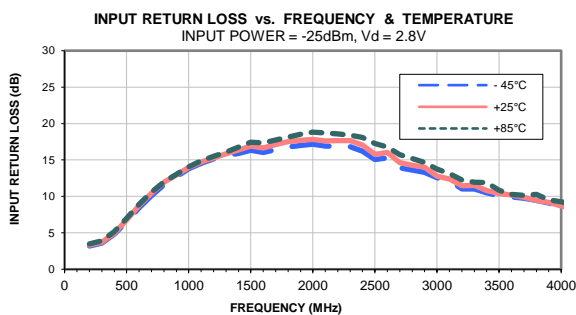
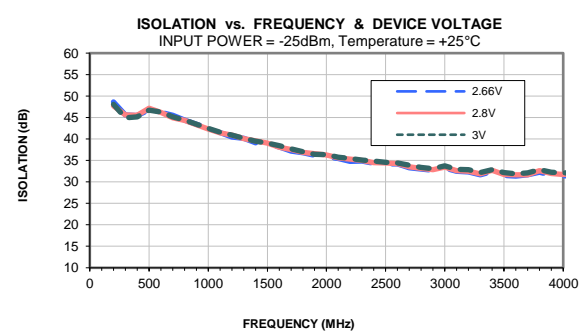
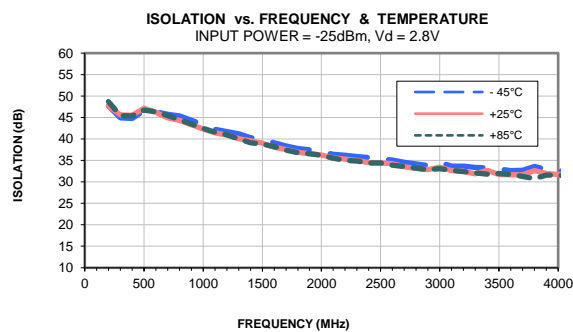
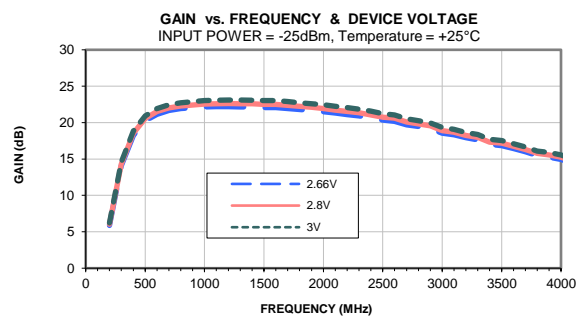
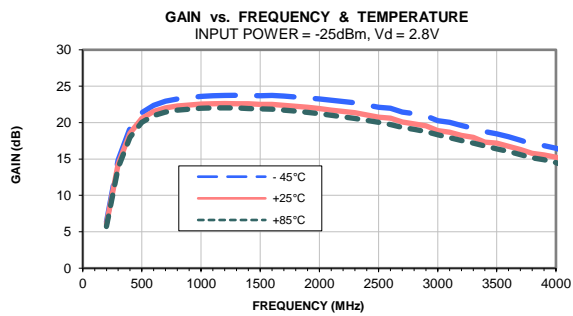

## Typical Performance Curves

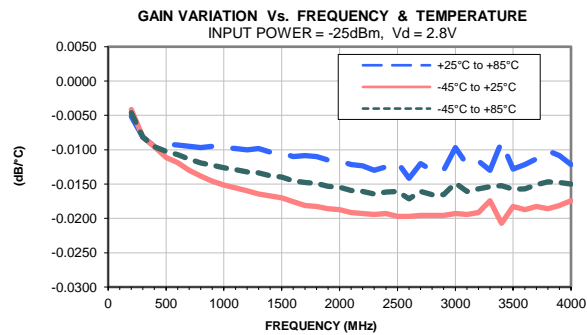
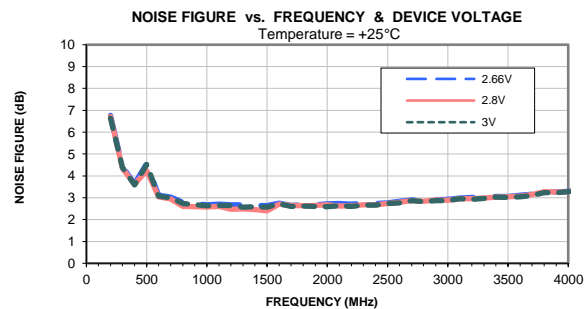
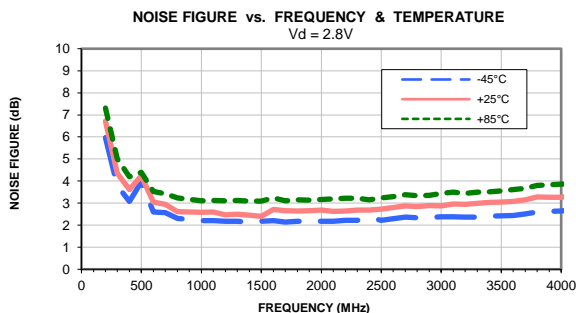
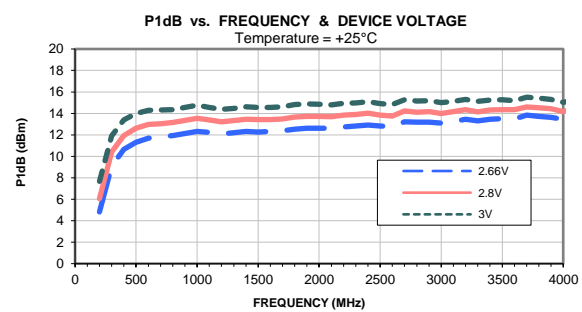
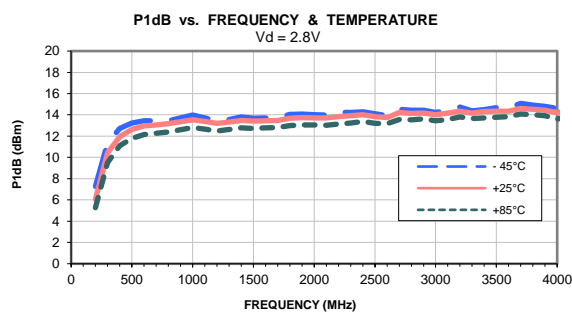
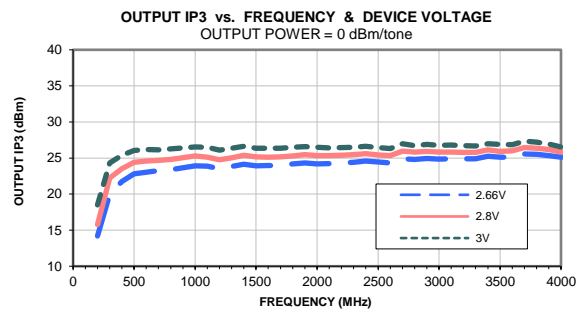
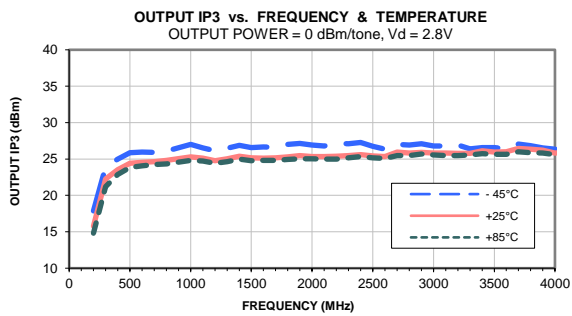

### Outline Dimensions

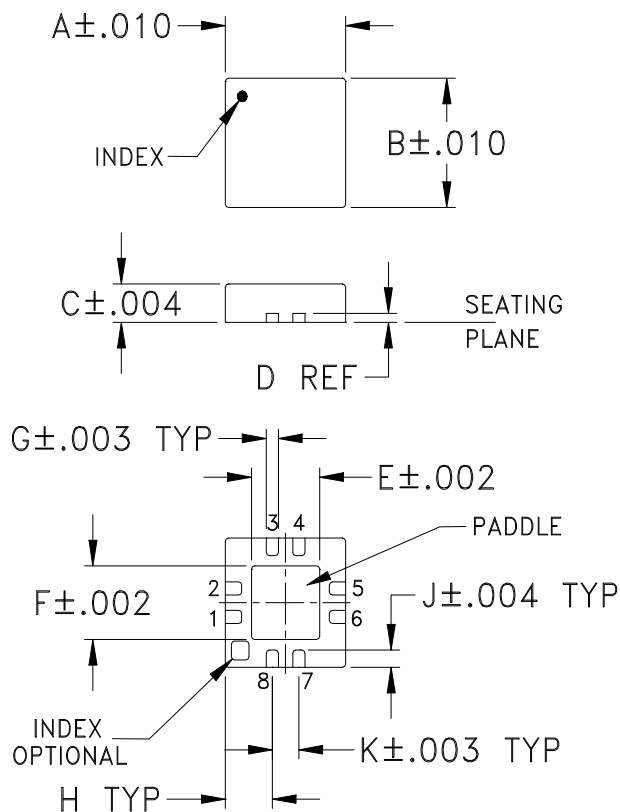

### PCB Land Pattern

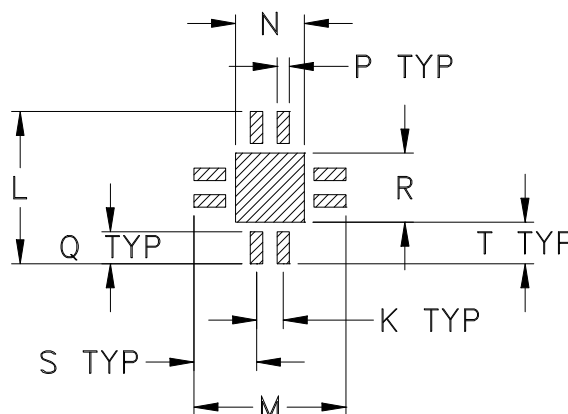

Suggested Layout,  
Tolerance to be within  $\pm.002$

CASE #	A	B	C	D	E	F	G	H	J	K	L	M	N
DQ849	.118 (3.00)	.118 (3.00)	.035 (0.89)	.008 (0.20)	.067 (1.70)	.067 (1.70)	.012 (0.30)	.046 (1.17)	.016 (0.41)	.026 (0.66)	.148 (3.76)	.148 (3.76)	.067 (1.70)

CASE #	P	Q	R	S	T	WT. GRAM
DQ849	.012 (0.30)	.031 (0.79)	.067 (1.70)	.061 (1.55)	.041 (1.04)	.02

Dimensions are in inches (mm). Tolerances: 2Pl.  $\pm.01$ ; 3 Pl.  $\pm.004$

#### Notes:

- Case material: Plastic.
- Termination finish:  
For RoHS Case Styles: Tin-Silver alloy plate over Nickel barrier or Matte-Tin plated. All models, (+) suffix. See Data sheet.  
For RoHS-5 Case Styles: Tin-Lead plate. All models. no (+) suffix.



INTERNET <http://www.minicircuits.com>

P.O. Box 350166, Brooklyn, New York 11235-0003 (718) 934-4500 Fax (718) 332-4661

Distribution Centers NORTH AMERICA 800-654-7949 • 417-335-5935 • Fax 417-335-5945 • EUROPE 44-1252-832600 • Fax 44-1252-837010

Mini-Circuits ISO 9001 & ISO 14001 Certified

# Tape & Reel Packaging TR-F104

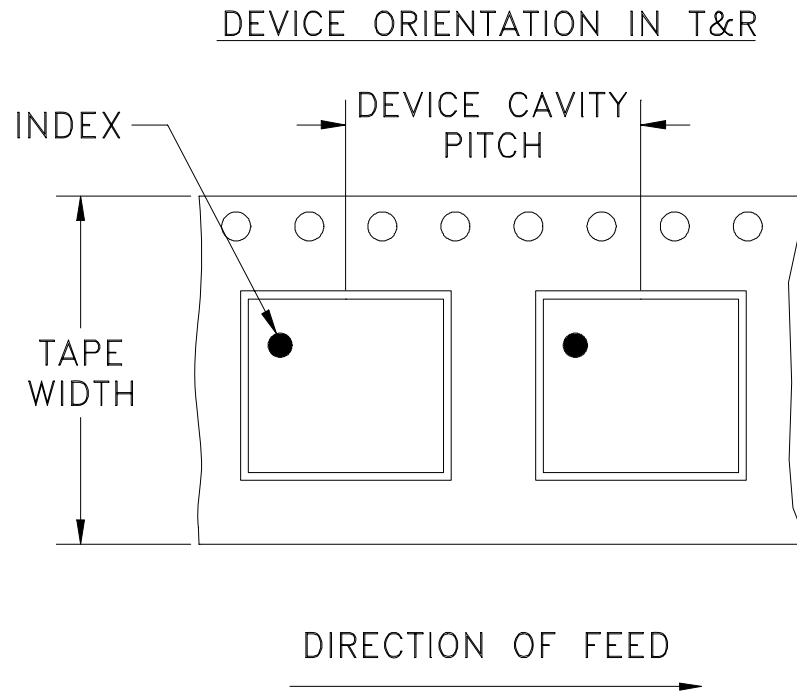

Tape Width, mm	Device Cavity Pitch, mm	Reel Size, inches	Devices per Reel	
8	4	7	Small quantity standards (see note)	20
				50
				100
				200
				500
				1000
		7	Standard	2000

Note: Please Consult individual model data sheet to determine device per reel availability.

Mini-Circuits carrier tape materials provide protection from ESD (Electro-Static Discharge) during handling and transportation. Tapes are static dissipative and comply with industry standards EIA-481/EIA-541.

Go to: [www.minicircuits.com/pages/pdfs/tape.pdf](http://www.minicircuits.com/pages/pdfs/tape.pdf)



INTERNET <http://www.minicircuits.com>

P.O. Box 350166, Brooklyn, New York 11235-0003 (718) 934-4500 Fax (718) 332-4661

Distribution Centers NORTH AMERICA 800-654-7949 • 417-335-5935 • Fax 417-335-5945 • EUROPE 44-1252-832600 • Fax 44-1252-837010

Mini-Circuits ISO 9001 & ISO 14001 Certified

THIRD ANGLE PROJECTION

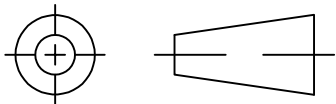

REVISIONS

REV	ECN No.	DESCRIPTION	DATE	DR	AUTH
OR	M82272	NEW RELEASE	08/05/02	GF	DJ
A	M82598	MODIFIED LAYOUT	08/12/02	GF	MM
B	M102713	ADDED "...WITH SMOBC"	01/14/06	GF	IL
C	ECO-003400	REMOVED COMP. VALUE, ADDED NOTE REF. TO EVAL. BOARD	07/23/20	ITG	IL

SUGGESTED MOUNTING CONFIGURATION  
FOR DQ849 CASE STYLE

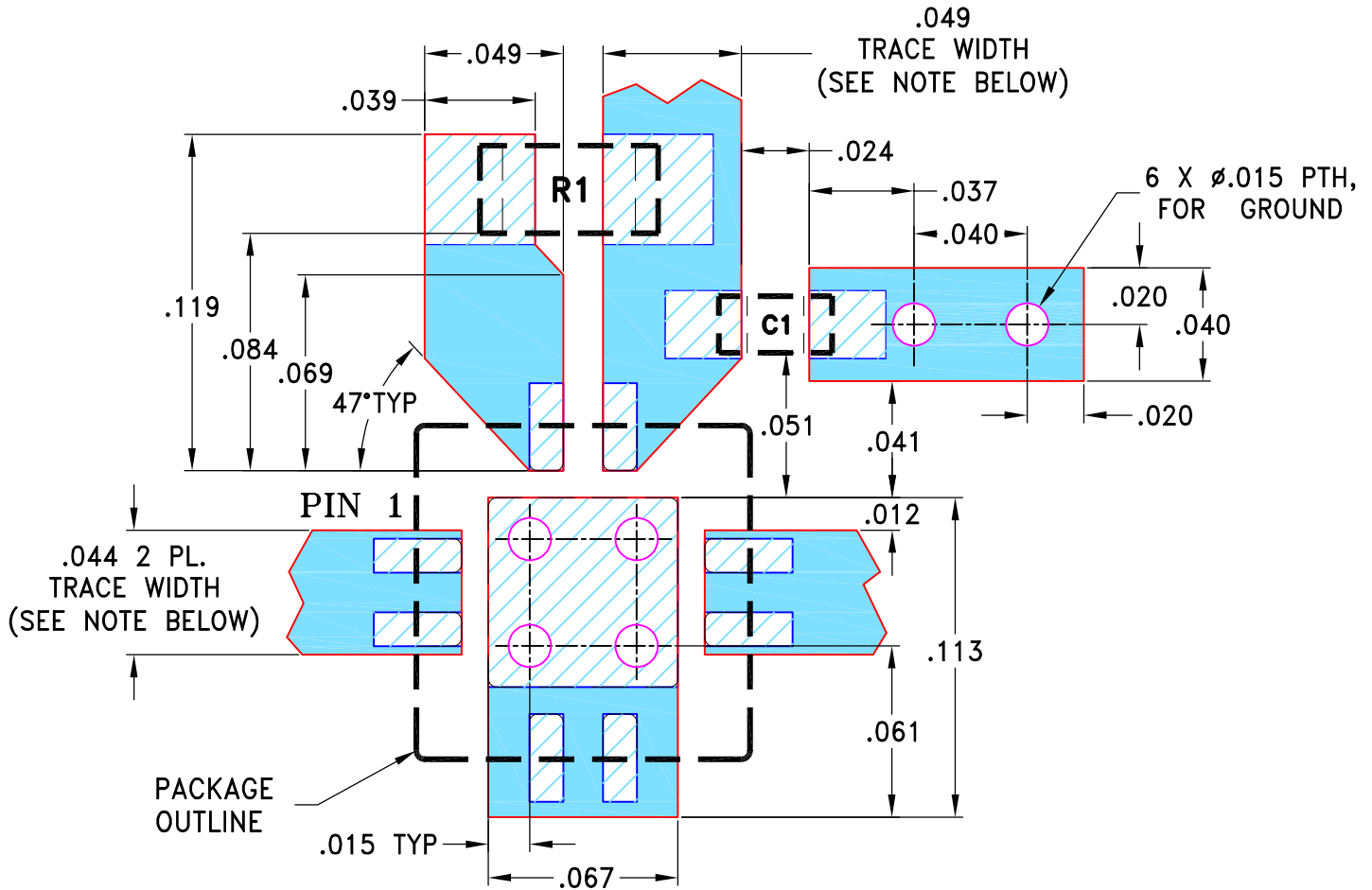

RESISTOR R1: 0603 SIZE  
CAPACITOR C1: 0402 SIZE

NOTES:

1. LINE WIDTH IS SHOWN FOR ROGERS R04350B WITH DIELECTRIC THICKNESS  $.020 \pm .0015$ ";  
COPPER: 1/2 OZ. FOR OTHER MATERIALS LINE WIDTH MAY NEED TO BE MODIFIED.
2. FOR "R1" & "C1" VALUES REFER TO THE CORRESPONDING EVALUATION BOARD TB-186-XX+.
3. BOTTOM SIDE OF THE PCB IS CONTINUOUS GROUND PLANE.

DENOTES PCB COPPER LAYOUT WITH SMOBC (SOLDER MASK OVER BARE COPPER)

DENOTES COPPER LAND PATTERN FREE OF SOLDER MASK

UNLESS OTHERWISE SPECIFIED	INITIALS	DATE
DIMENSIONS ARE IN INCHES	DRAWN GF	07/19/02
TOLERANCES ON:	CHECKED LC	08/01/02
2 PL DECIMALS ±	APPROVED DJ	08/05/02
3 PL DECIMALS ± .005		
ANGLES ±		
FRACTIONS ±		



**Mini-Circuits®** 13 Neptune Avenue  
Brooklyn NY 11235

PL, DQ849, TB-186-XX+

Mini-Circuits®  
THIS DOCUMENT AND ITS CONTENTS ARE THE PROPERTY OF MINI-CIRCUITS. EXCEPT FOR USE EXPRESSLY GRANTED, IN WRITING, TO ITS VENDORS, VENDEE AND THE UNITED STATES GOVERNMENT, MINI-CIRCUITS RESERVES ALL PROPRIETARY DESIGN, USE, MANUFACTURING AND REPRODUCTION RIGHTS THERETO. THESE CONTENTS SHALL NOT BE USED, DUPLICATED OR DISCLOSED TO ANY OUTSIDE PARTY, IN WHOLE OR IN PART, WITHOUT WRITTEN PERMISSION OF MINI-CIRCUITS.

SIZE	CODE IDENT	DRAWING NO:	REV:
A	15542	98-PL-078	C
FILE:	98PL078	SCALE:	15:1
		SHEET:	1 OF 1

# Evaluation Board and Circuit

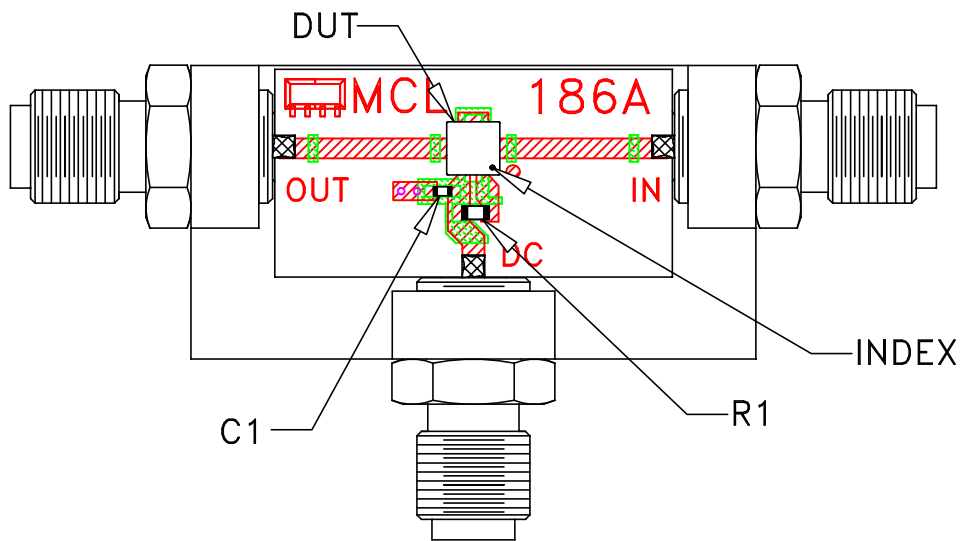

TB-186-6A+

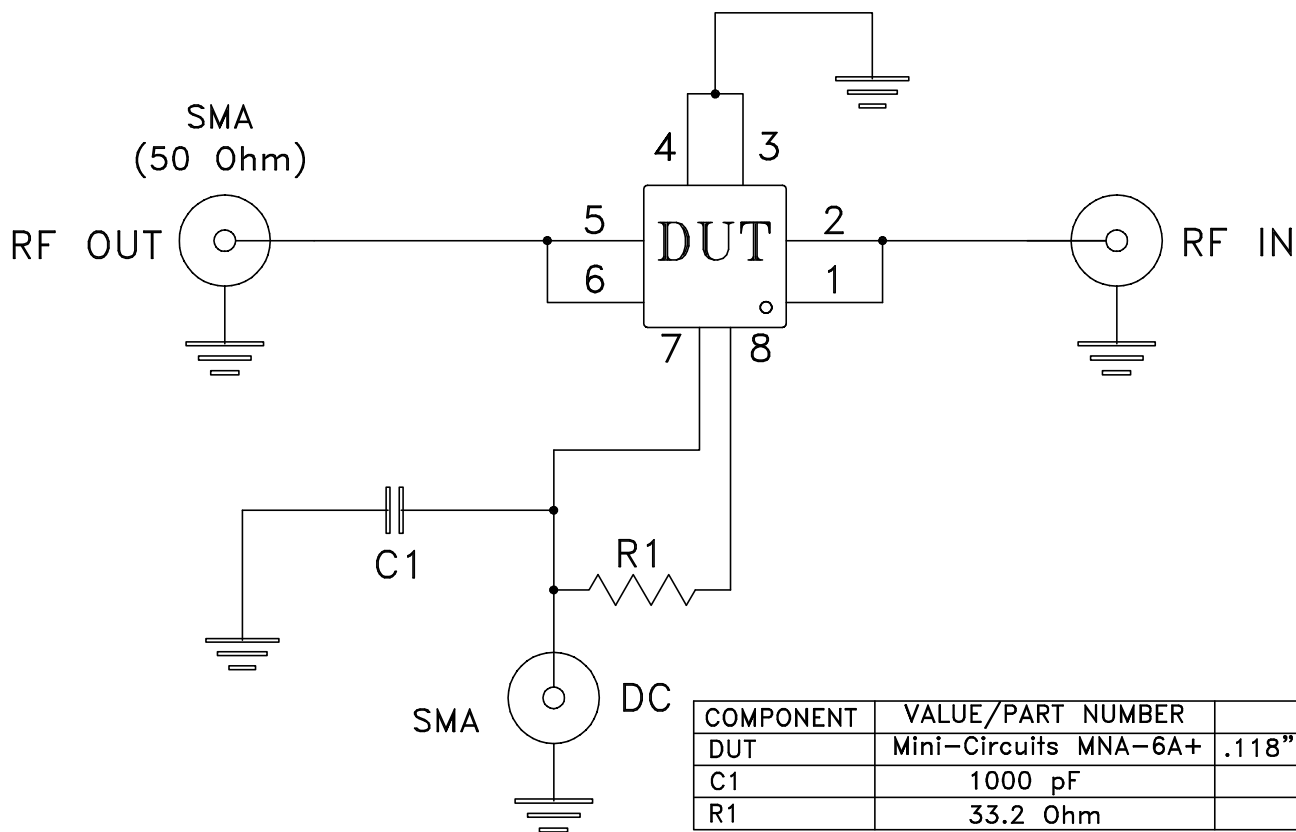

COMPONENT	VALUE/PART NUMBER	SIZE
DUT	Mini-Circuits MNA-6A+	.118"X.118"(3X3MM)
C1	1000 pF	0603
R1	33.2 Ohm	0805

Schematic Diagram

## Notes:

1. SMA Female connectors.
2. PCB Material: Rogers R04350 or equivalent, Dielectric Constant=3.5, Thickness=.020 inch.
3. Pins 1 and 6 have no internal connecton.
4. Paddle underneath DUT must be grounded.

 **Mini-Circuits®**

All Mini-Circuits products are manufactured under exacting quality assurance and control standards, and are capable of meeting published specifications after being subjected to any or all of the following physical and environmental test.

Specification	Test/Inspection Condition	Reference/Spec
Operating Temperature	-40° to 85°C or -45° to 85°C Ambient Environment	Individual Model Data Sheet
Storage Temperature	-55° to 100° C or -65° to 150° Ambient Environment	Individual Model Data Sheet
Thermal Shock	-55° to 100°C, 100 cycles	MIL-STD-202, Method 107, Condition A-3, except +100°C
Mechanical Shock	1.5Kg, 0.5 ms, 5 shock pulses, Y1 direction only	MIL-STD-883, Method 2002, Condition B, except Y1 direction only
Vibration (Variable Frequency)	50g peak	MIL-STD-883, Method 2007, Condition B
Autoclave	15 psig, 100% RH, 121°C, 96 hours	JESD22-A102, Condition C
HAST	130°C, 85% RH, 96 hours	JESD22-A110
Solderability	10X Magnification	J-STD-002, Para 4.2.5, Test S, 95% Coverage
Solder Reflow Heat	Sn-Pb Eutetic Process: 240°C peak Pb-Free Process: 260°C peak	J-STD-020, Table 4-1, 4-2 and 5-2; Figure 5-1
Moisture Sensitivity: Level 1	Bake at 125°C for 24 hours Soak at 85°C/85% RH for 168 hours, Reflow 3 cycles at 260°C peak	J-STD-020
Marking Resistance to Solvents	Isopropyl alcohol + mineral spirits at 25°C; terpene defluxer at 25°C; distilled water + proylene glycol monomethyl ether +	MIL-STD-202, Method 215





All Mini-Circuits products are manufactured under exacting quality assurance and control standards, and are capable of meeting published specifications after being subjected to any or all of the following physical and environmental test.

<b>Specification</b>	<b>Test/Inspection Condition</b>	<b>Reference/Spec</b>
	monoethanolamine at 63°C to 70°C	