

Opt-Pass Sensor

FEATURES

- Built-in function of visible light cut-off filter
- Miniature, thin package: 2.3mm x 2.0mm x 0.6mm
- Pb free soldering re-flowing permitted: 255°C, 2times
- Halogen free, Pb free
- Compliant with RoHS directive

APPLICATION

- Detecting the location of AF Lens unit for DSC,DVC
- Detecting the location of Zoom Lens unit for DSC,DVC
- Positioning for high precision

EQUIVALENT CIRCUIT-BLOCK DIAGRAM

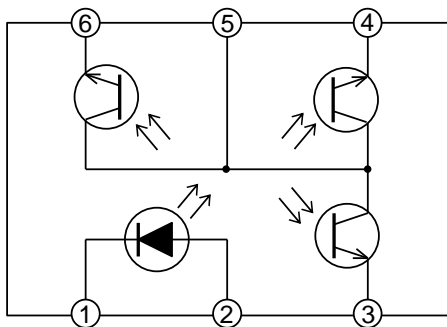

GENERAL DESCRIPTION

The NJL9101R is the high-precision optical position sensor, which is combining with a super luminosity RED LED and Si light-sensitive element into small package. Three sin waves with high precision phase difference will output by using the dedicated striped mirror. By arithmetic processing of the sensor output signal, the position detection with high precision and high resolution can be performed.

The characteristics by optical scheme are not affected from the magnetic field of magnet that built into the motor etc. The Opt-Pass sensor has been designed strongly against the distance variation between the sensor and the striped mirror. Also the Opt-pass has been designed strongly against the tilt variation.

1. Cathode (LED)
2. Anode (LED)
3. Emitter1 (Out1)
4. Emitter2 (Out2)
5. Collector (Common Emitter1,2,3)
6. Emitter3 (Out3)

PIN CONFIGURATION

PIN No	NAME	FUNCTION
1	Cathode (LED)	Cathode for LED
2	Anode (LED)	Anode for LED
3	Emitter1 (Out1)	Emitter1 for Photo Tr
4	Emitter2 (Out2)	Emitter2 for Photo Tr
5	Collector	Collector (Common Emitter1,2,3)
6	Emitter3 (Out3)	Emitter3 for Photo Tr

(Top View)

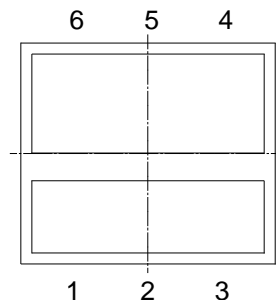

ORDERING INFORMATION

PART NUMBER	PACKAGE OUTLINE	RoHS	HALOGEN-FREE	TERMINAL FINISH	MARKING	WEIGHT (mg)	MOQ(pcs)
NJL9101R	COBP	yes	yes	Au	No marking	4.5	2,000

■ABSOLUTE MAXIMUM RATINGS

PARAMETER	SYMBOL	RATING	UNIT
Emitter			
Forward Current (Continuous)	I_F	15	mA
Reverse Voltage (Continuous)	V_R	6	V
Power Dissipation	P_D	45	mW
Detector			
Collector-Emitter Voltage	V_{CEO}	16	V
Emitter-Collector Voltage	V_{ECO}	6	V
Collector Current	I_C	10	mA
Collector Power Dissipation	P_C	25	mW
Coupled			
Total Power Dissipation	P_{tot}	60	mW
Operating Temperature	T_{opr}	-30 to +70	°C
Storage Temperature	T_{stg}	-30 to +85	°C
Reflow Soldering Temperature	T_{sol}	255	°C

■RECOMMENDATION OPERATING CONDITION

PARAMETER	SYMBOL	VALUE	UNIT
Forward current	I_F	5	mA
Collector-Emitter Voltage	V_{CEO}	+2.0 to +3.3	V
Distance between sensor and reflector	Gap	0.7	mm

■ELECTRO-OPTICAL CHARACTERISTICS DC ($T_a=25^\circ\text{C}$)

PARAMETER	SYMBOL	TEST CONDITION	MIN.	TYP.	MAX.	UNIT
Emitter						
Forward Voltage	V_F	$I_F=5\text{mA}$	1.1	1.4	1.7	V
Revers Voltage	I_R	$V_R=6\text{V}$	-	-	10	μA
Peak wavelength	λ_P		-	850	-	nm
Detector						
Dark Current	I_{CEO}	$V_{CE}=5\text{V}$, In the dark	-	-	0.5	μA
Collector-Emitter Voltage	V_{CE}	$I_C=100\mu\text{A}$, In the dark	16	-	-	V
Coupled						
Output Current 1	I_{o1}	$I_F=5\text{mA}$, $V_{CE}=3.3\text{V}$, $d=0.7\text{mm}$ (Al Mirror) *1	153	300	550	μA
Output Current 2	I_{o2}	$I_F=5\text{mA}$, $V_{CE}=3.3\text{V}$, $d=0.7\text{mm}$ (Al Mirror) *1	153	300	550	μA
Output Current 3	I_{o3}	$I_F=5\text{mA}$, $V_{CE}=3.3\text{V}$, $d=0.7\text{mm}$ (Al Mirror) *1	153	300	550	μA
Operating Dark Current 1	I_{CEOD1}	$I_F=5\text{mA}$, $V_{CE}=3.3\text{V}$	-	-	0.5	μA
Operating Dark Current 1	I_{CEOD2}	$I_F=5\text{mA}$, $V_{CE}=3.3\text{V}$	-	-	0.5	μA
Operating Dark Current 1	I_{CEOD3}	$I_F=5\text{mA}$, $V_{CE}=3.3\text{V}$	-	-	0.5	μA

*1 Output Current is the value obtained that is used the reflective board of Aluminum Evaporation Design Guarantee Item. Items that are showed only the typical value are not tested in manufacturing process.

■ELECTRO-OPTICAL CHARACTERISTICS AC (Ta=25°C)

PARAMETER	SYMBOL	TEST CONDITION	MIN.	TYP.	MAX.	UNIT
Coupled						
Output Voltage 1	V_{o1}	$I_F=5mA, V_{CE}=3.3V, R_L=2k\Omega, d=0.7mm *2$	—	90	—	mVp-p
Output Voltage 2	V_{o2}	$I_F=5mA, V_{CE}=3.3V, R_L=2k\Omega, d=0.7mm *2$	—	90	—	mVp-p
Output Voltage 3	V_{o3}	$I_F=5mA, V_{CE}=3.3V, R_L=2k\Omega, d=0.7mm *2$	—	90	—	mVp-p
Phase Difference 2	V_{o2P}	Phase Difference to Output Voltage 1	—	90	—	deg
Phase Difference 3	V_{o3P}	Phase Difference to Output Voltage 1	—	180	—	deg
Cut-off Frequency	f_c	$V_{CE}=3.3V, R_L=2k\Omega, -3dB$	—	20	—	kHz

*2 Output Voltage is the value obtained that is used the dedicated striped mirror (Metal type : Meltec Corporation).

Design Guarantee Item. Items that are showed only the typical value are not tested in manufacturing process.

The minimum and maximum values are reference values.

■OUTPUT CURRENT TEST CONDITION

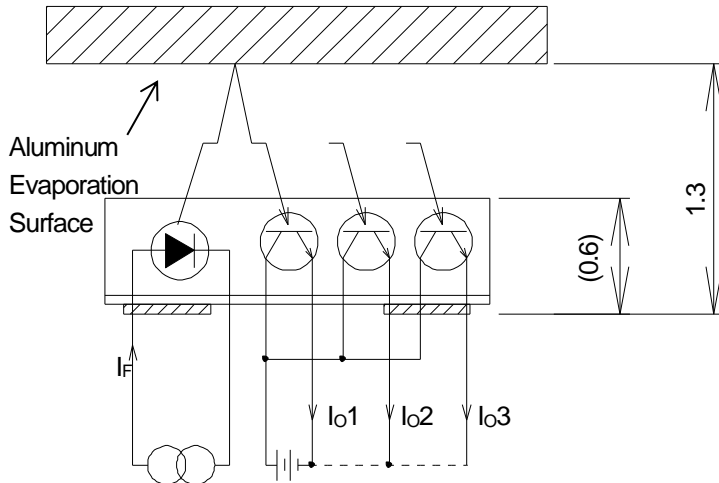

■DARK CURRENT TEST CONDITION

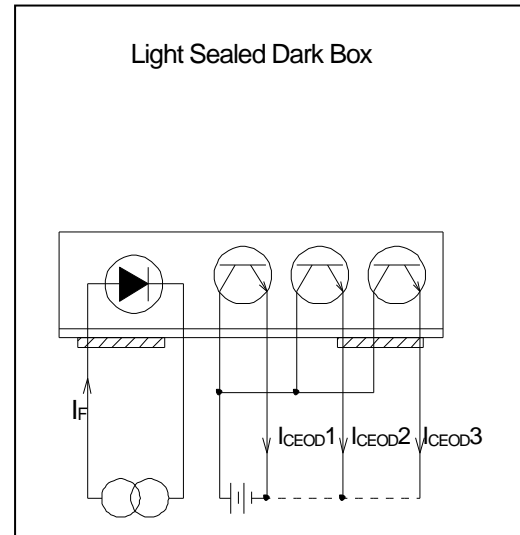

OUTPUT VOLTAGE TEST CONDITION

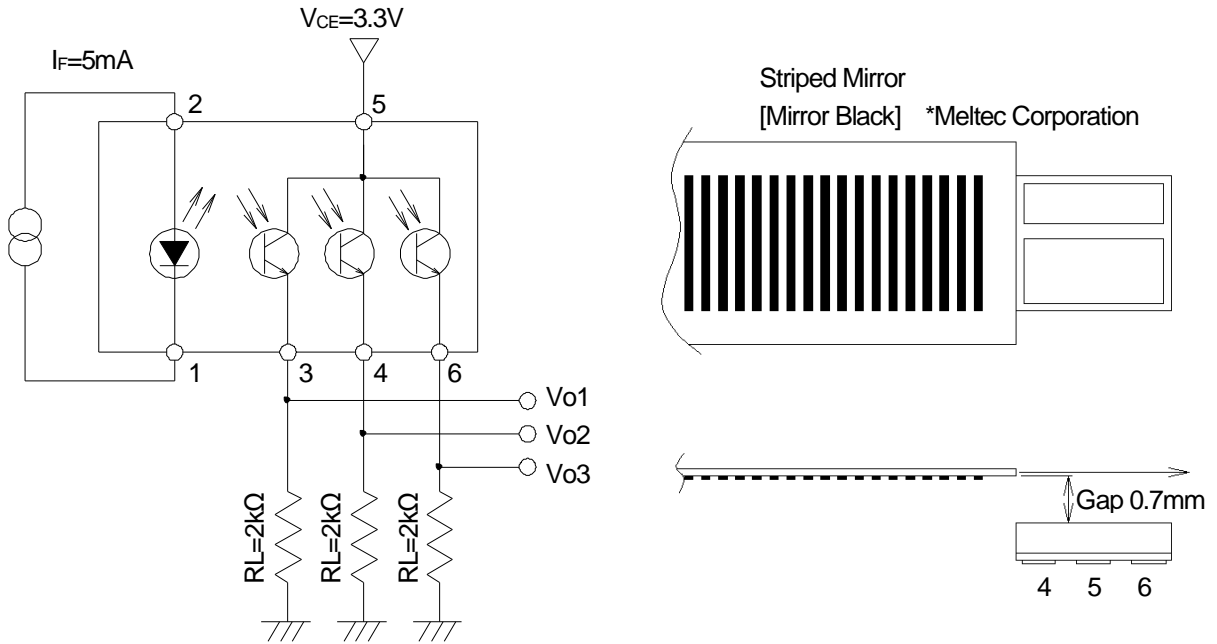

Output Characteristics of Striped mirror (Mirror Black @126um/126um)
(Gap=0.7mm, I_F=5mA, V_{CC}=3.3V, R_L=2kΩ, T_a=25°C)

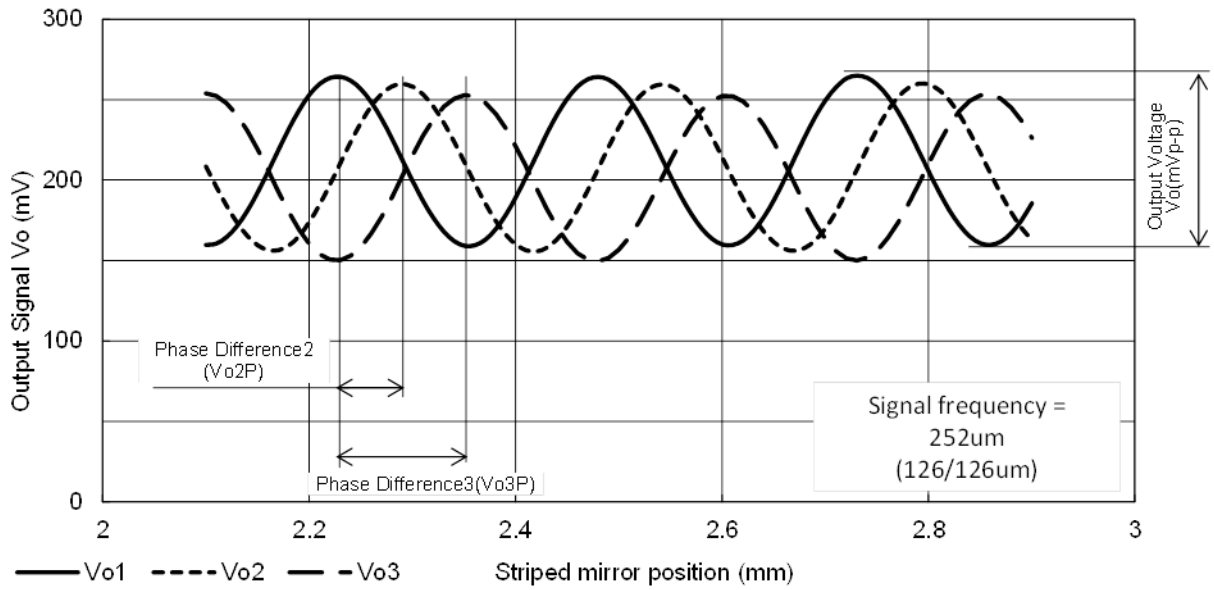

■POWER DISSIPATION vs. AMBIENT TEMPERATUR

Power Dissipation vs. Temperature

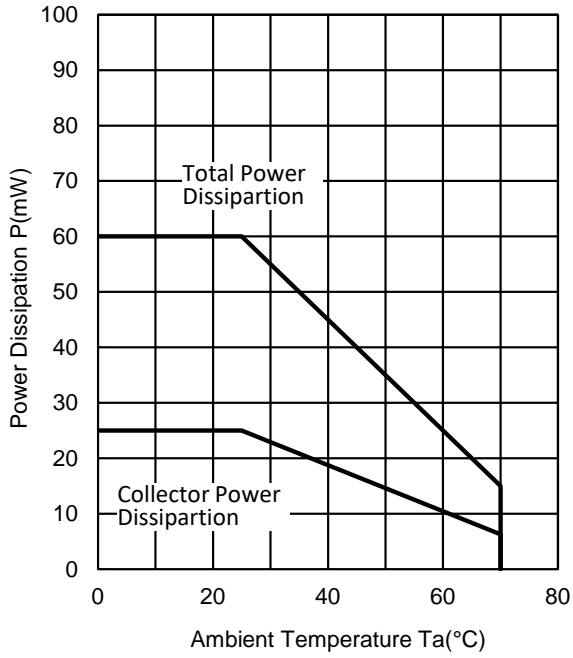

Forward Current vs. Temperature

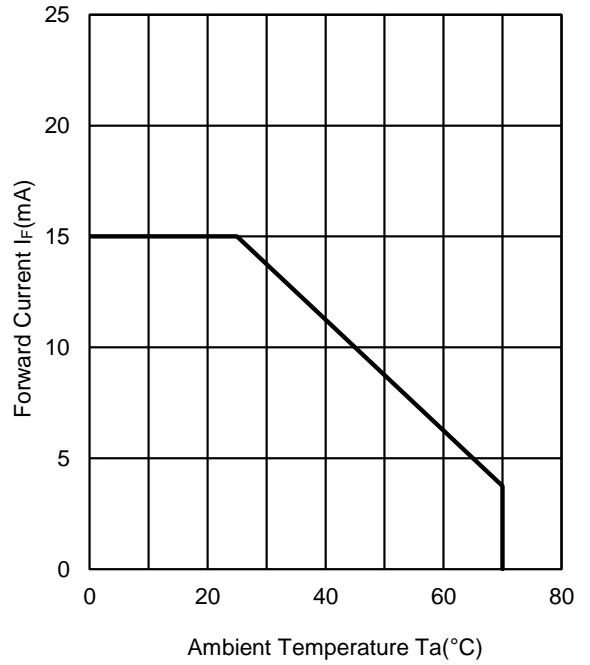

■ TYPICAL CHARACTERISTICS (Ta=25°C)

Forward Voltage vs. Forward Current

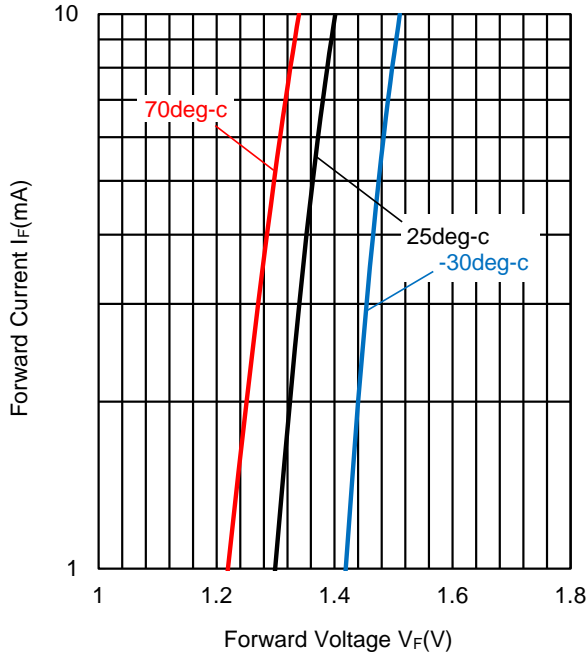

Forward Voltage vs. Temperature

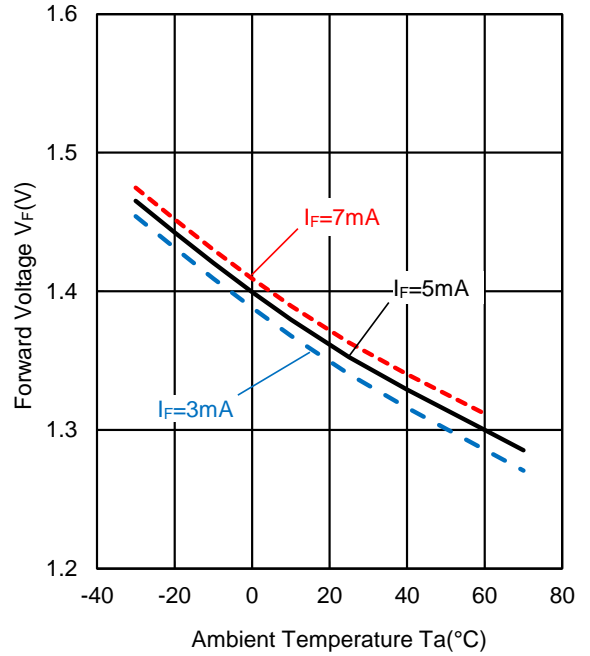

Dark Current vs. Temperature
 $V_{CE0}=3.3V$

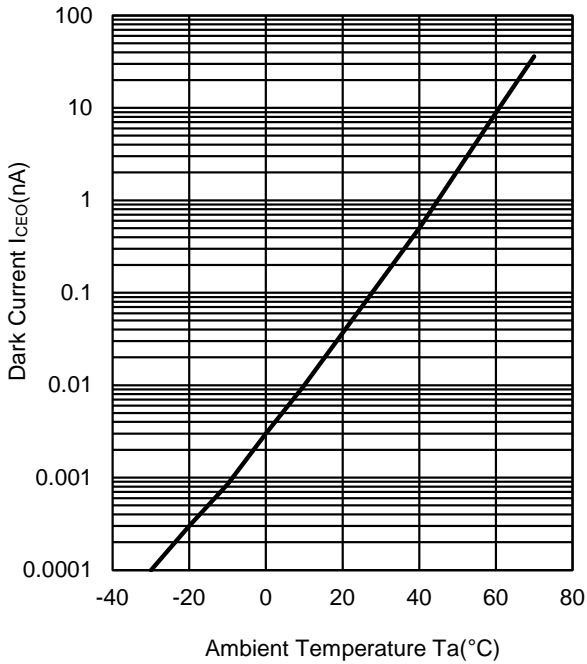

Operating Dark Current vs. Temperature
 $I_F=5mA, V_{CE0}=3.3V$

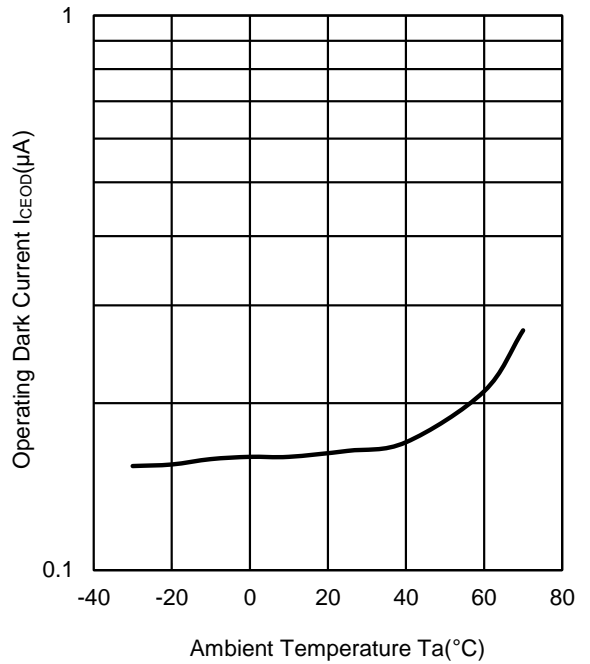

■ TYPICAL CHARACTERISTICS (Ta=25°C)

Output Current vs. Forward Current
100% @I_F=5mA

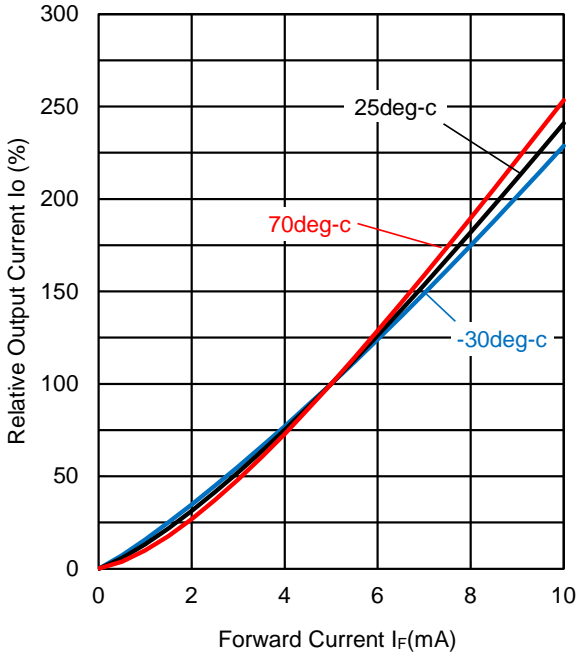

Output Current vs. Temperature

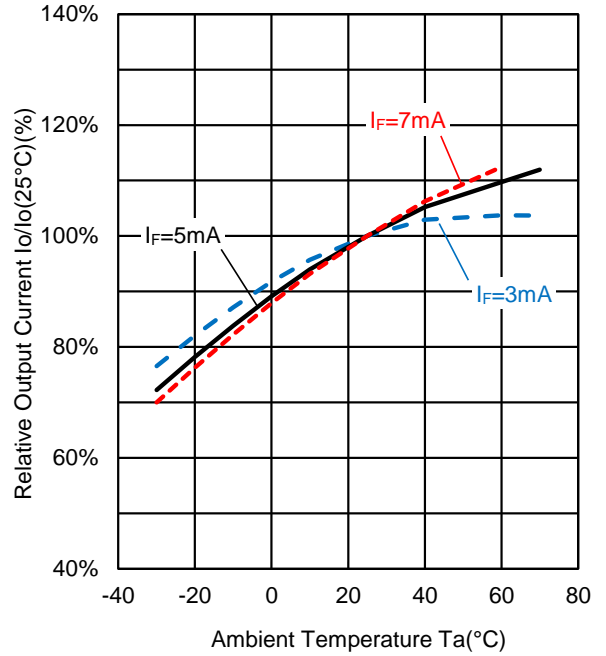

Output Current vs. Gap (Ta=25°C)
100% @Gap=0.7mm

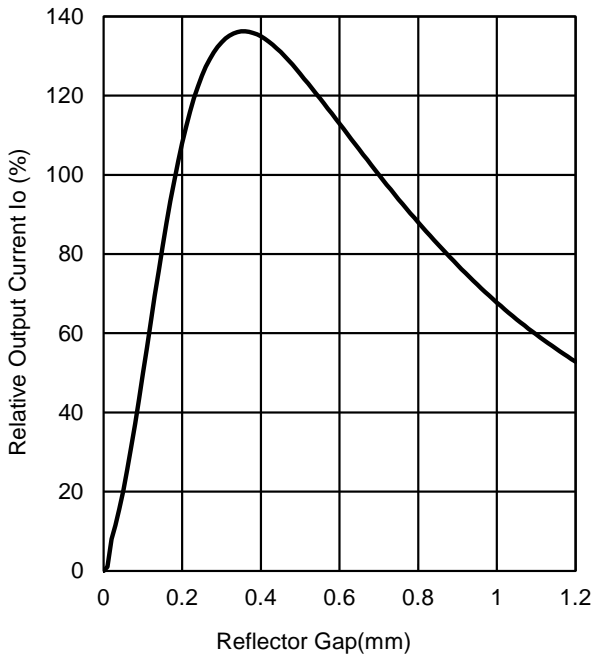

Frequency Response (Ta=25°C)

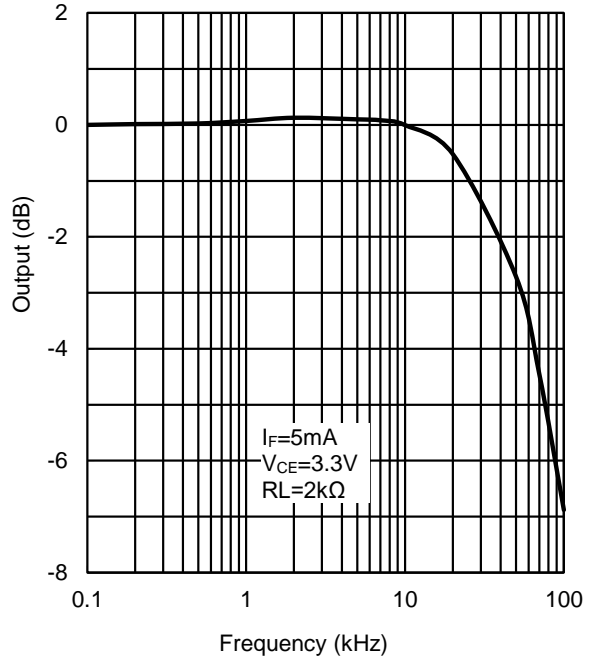

■ TYPICAL CHARACTERISTICS (Ta=25°C)

Spectral Response (Ta=25°C)
Emitter

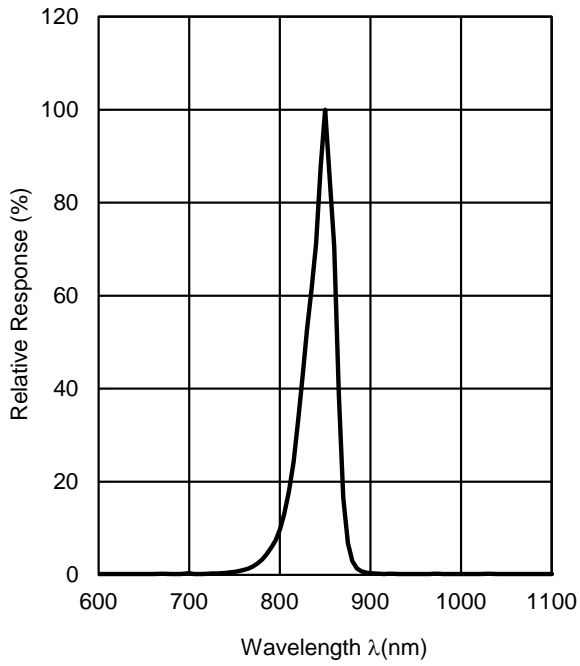

Spectral Response (Ta=25°C)
Detector

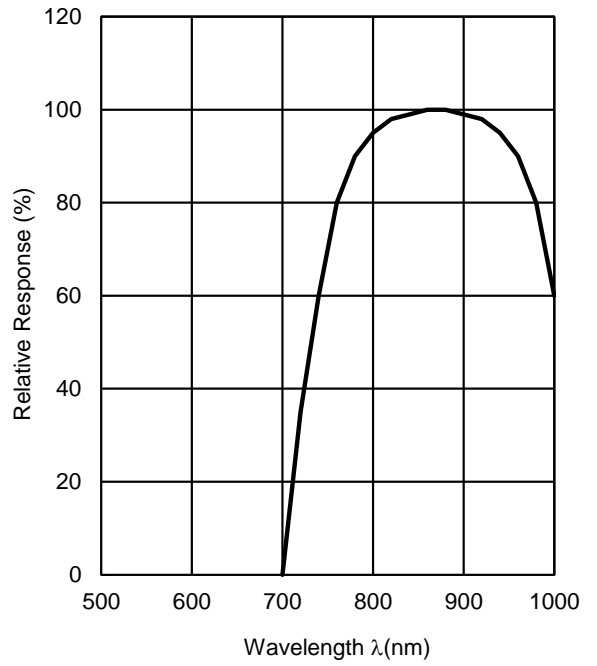

■STRIPED MIRROR OUTLINE (typ.) Unit : mm

1) Metal Type (Mirror Black : Meltec Corporation)

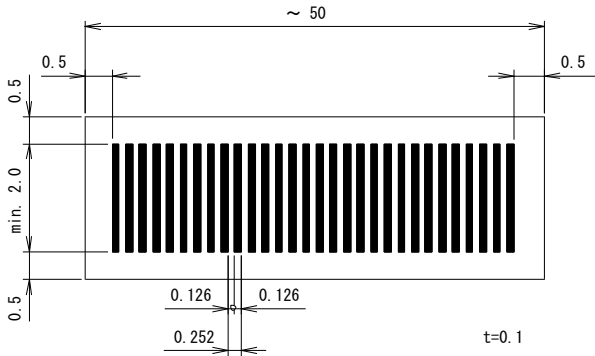

Outline Tolerance	$\pm 0.1\text{mm}$
Dimension for Reflective Pattern	$0.126\text{mm} \pm 0.003\text{mm}$
Dimension for Non-Reflective Pattern	$0.126\text{mm} \pm 0.003\text{mm}$
Pattern Pitch	0.252mm

■APPLICATION NOTE**(1) Attention in handling**

Treat not to touch the light receiving and light emitting part.

Avoid to adhering the dust and any other foreign materials on the light receiving and light emitting part when using.

When LED has operated by voltage, it should be connected the resistor of current adjustment. Avoid to applying direct voltage to LED, because there is possibility that LED is destroyed.

When mounting, special care has to be taken on the mounting position and tilting of the device because it is very important to place the device to the optimum position to the object.

(2) Attention in designing

Avoid the entering ambient light into light receiving part for avoid the malfunction by ambient light. Furthermore, there is possibility of malfunction when there are the other mounted parts by near this product peripheral.

There will be changing characteristics by detection object. Refer to this datasheet and evaluate by actual detection object.

When LED has been applied continuous power on long period of time, the output current is dropped. If it uses by always applying power to LED, have to consider the circuit designing of including output current decrease.

■PACKAGE OUTLINE UNIT (mm)

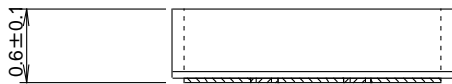
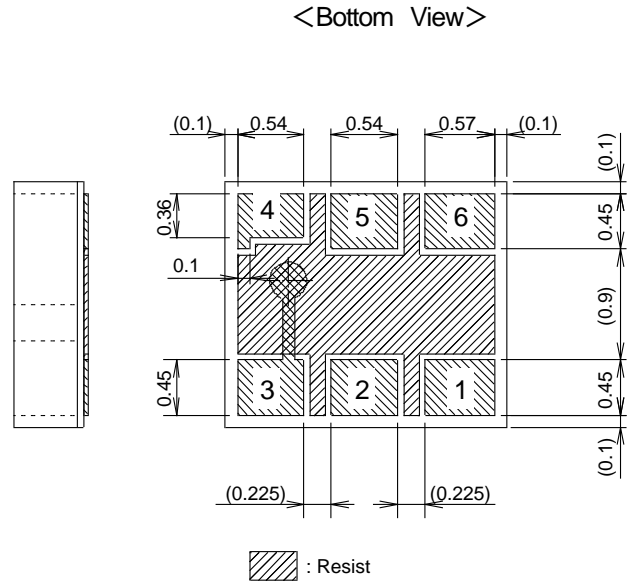
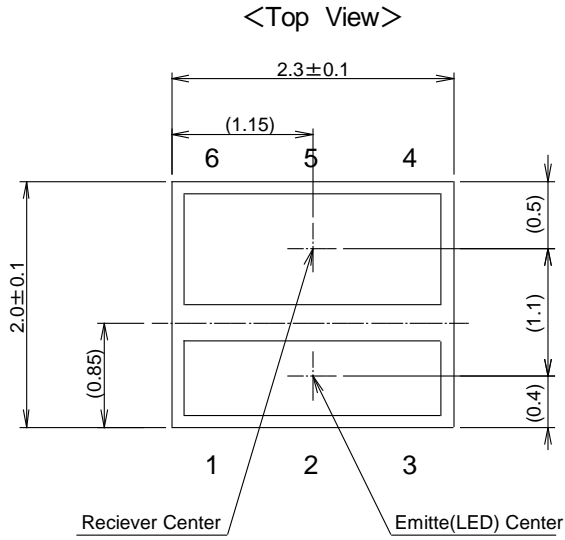

1. Cathode (LED)
2. Anode (LED)
3. Emitter1 (Out1)
4. Emitter2 (Out2)
5. Collector (Common Emitter1,2,3)
6. Emitter3 (Out3)

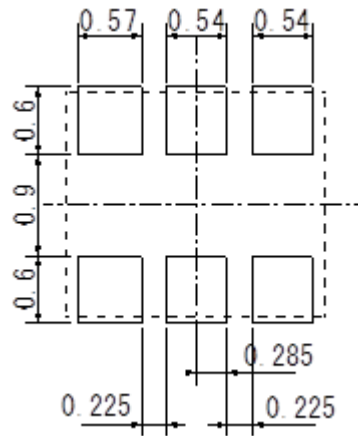

PCB Pattern

PACKING SPECIFICATION

PACKING DIMENSIONS UNIT: mm

Insert direction

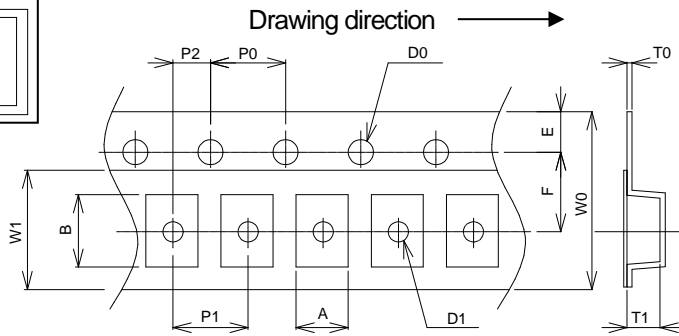
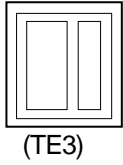

SYMBOL	DIMENSION	REMARK
A	2.20±0.05	BOTTOM DIMENSSION
B	2.55±0.10	BOTTOM DIMENSSION
D0	φ1.50 ^{+0.10}	
D1	φ1.00±0.10	
E	1.75±0.10	
F	3.50±0.05	
P0	4.00±0.10	
P1	4.00±0.10	
P2	2.00±0.05	
T0	0.20±0.05	
T1	0.80±0.10	
W0	8.00±0.20	
W1	5.40±0.10	THICKNESS 0.1MAX.

Carrier tape material: PC(Antistatic)
Cover tape material: PETP(Antistatic)

TAPING STRENGTH

There is a peel strength in the range of 0.2 to 0.7N when was peeled at a rate of 300mm per minute in opening angle 165 to 180° between the carrier tape and the cover tape.

PACKAGING

- 1) The taped products are to be rolled up on the taping reel as on the drawing.
- 2) Rolling up specification
 - 2-1) Start rolling : Carrier tape open space more than 20 Pieces.
 - 2-2) End of rolling : Carrier tape open space more than 20 Pieces, and 2 round of reel space at the cover tape only.
- 3) Taping quantity : 2,000 Pieces
- 4) Seal off after putting each reels in a damp proof bag with silica gel.

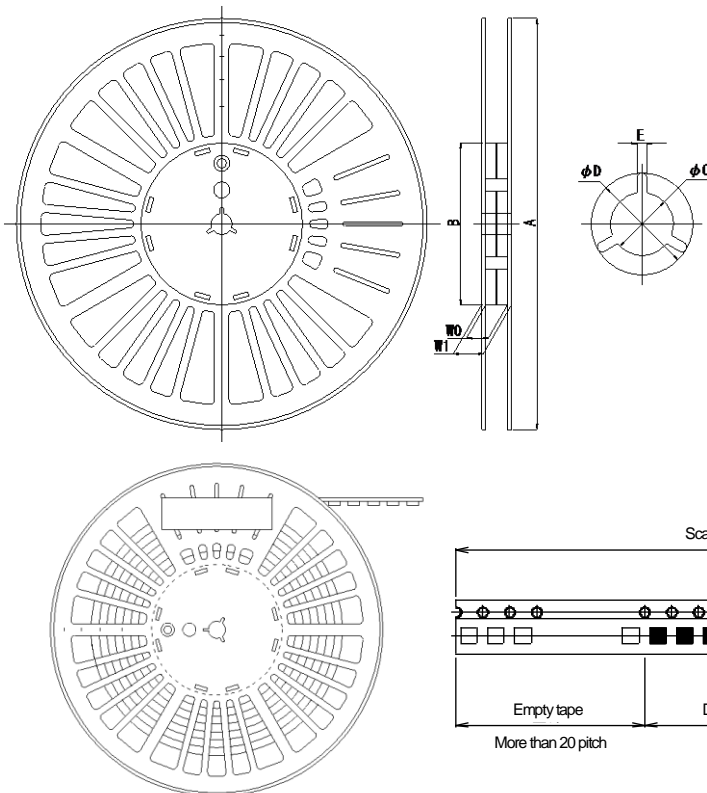

SYMBOL	DIMENSION	REMARK
A	φ180.0±1.0	
B	φ60.0±0.5	
C	φ13.0±0.2	
D	φ21.0±0.8	
E	2.0±0.5	
W0	9.0±0.5	
W1	12.0±0.5	

Reel material: PS(Antistatic)

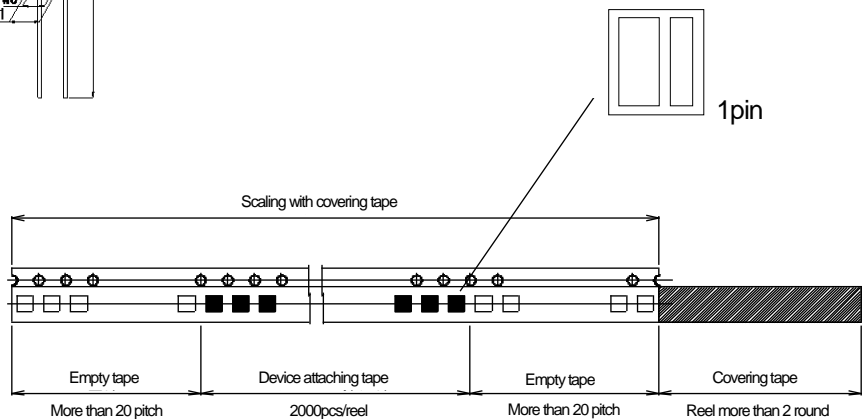

RECOMMENDED MOUNTING METHOD

NOTE

Mounting was evaluated with the following profiles in our company, so there was no problem.
However, confirm mounting by the condition of your company beforehand.

The exposure of device under higher temperature many affect to the reliability of the products, it is recommended to complete soldering in the shortest time possible.

Mounting: Two Times soldering is allowed.

INFRARED REFLOW SOLDERING METHOD

Recommended reflow soldering procedure

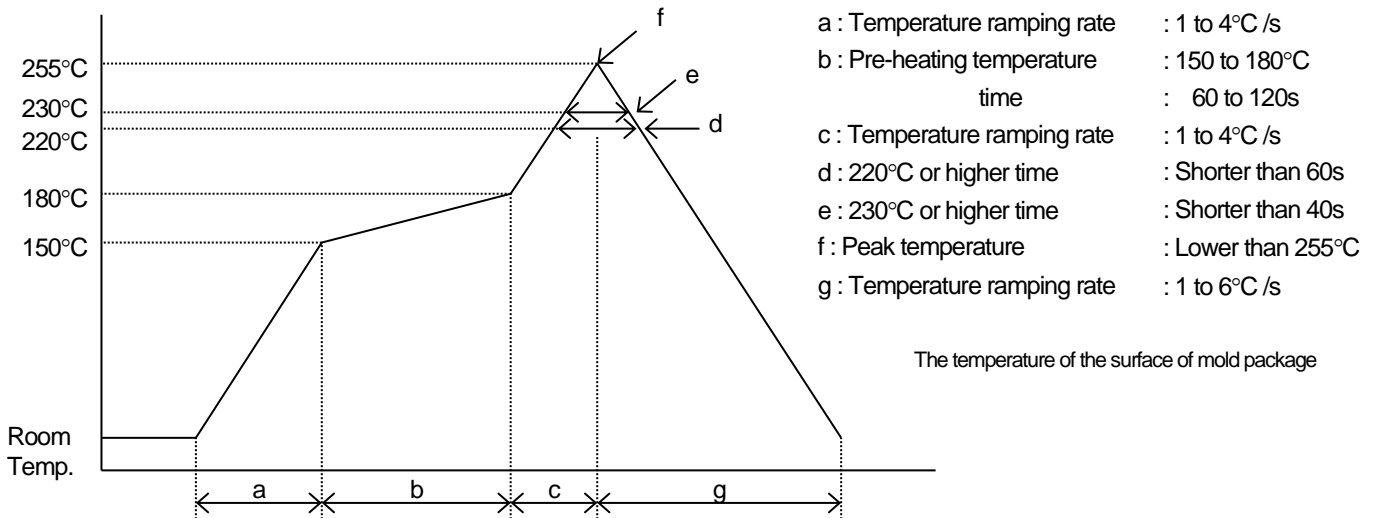

(NOTE1) Using reflow furnace with short wave infrared radiation heater such as halogen lamp

Regarding temperature profile, please refer to those of reflow furnace.

In this case the resin surface temperature may become higher than lead terminals due to endothermic ally of black colored mold resin. Therefore, please avoid from direct exposure to mold resin.

(NOTE2) Other method

Such other methods of soldering as dipping the device into melted solder and vapor phase method (VPS) are not appropriate because the body of device will be heated rapidly. Therefore, these are not recommended to apply.

(NOTE3) The resin gets softened right after soldering, so, the following care has to be taken

Not to contact the lens surface to anything.

Not to dip the device into water or any solvents.

FLOW SOLDERING METHOD

Flow soldering is not possible.

IRON SOLDERING METHOD

Iron soldering is not possible.

■CLEANING

Avoid washing the device after soldering by reflow method.

■IC STORAGE CONDITIONS AND ITS DURATION

(1) Temperature and humidity ranges

Pack Sealing	Temperature:	5 to 40 [°C]
	Humidity:	40 to 80 [%]
Pack Opening	Temperature:	5 to 30 [°C]
	Humidity:	40 to 70 [%]

After opening the bag, solder products within 48h.

Avoid a dry environment below 40% because the products are easily damageable by the electrical discharge.

Store the products in the place where it does not create dew with the products due to a sudden change in temperature.

- (2) When baking, place the reel vertically to avoid load to the side.
- (3) Do not store the devices in corrosive-gas atmosphere.
- (4) Do not store the devices in a dusty place.
- (5) Do not expose the devices to direct rays of the sun.
- (6) Do not allow external forces or loads to be applied to IC's.
- (7) Be careful because affixed label on the reel might be peeled off when baking.
- (8) The product is recommended to do the baking before using for the stability of the quality.

■BAKING

In case of keeping expect above condition be sure to apply baking.

Baking method: Ta=60°C, 48 to 72h, Three time baking is allowed

■STORAGE DURATION

Within a year after delivering this device.

For the products stored longer than a year, confirm their terminals and solderability before they are used.

■MOISTURE SENSITIVITY LEVELS

JEDEC : Level 5

[CAUTION]

1. New JRC strives to produce reliable and high quality semiconductors. New JRC's semiconductors are intended for specific applications and require proper maintenance and handling. To enhance the performance and service of New JRC's semiconductors, the devices, machinery or equipment into which they are integrated should undergo preventative maintenance and inspection at regularly scheduled intervals. Failure to properly maintain equipment and machinery incorporating these products can result in catastrophic system failures
2. The specifications on this datasheet are only given for information without any guarantee as regards either mistakes or omissions. The application circuits in this datasheet are described only to show representative usages of the product and not intended for the guarantee or permission of any right including the industrial rights.
All other trademarks mentioned herein are property of their respective companies.
3. To ensure the highest levels of reliability, New JRC products must always be properly handled.
The introduction of external contaminants (e.g. dust, oil or cosmetics) can result in failures of semiconductor products.
4. New JRC offers a variety of semiconductor products intended for particular applications. It is important that you select the proper component for your intended application. You may contact New JRC's Sale's Office if you are uncertain about the products listed in this catalog.
5. Special care is required in designing devices, machinery or equipment which demand high levels of reliability. This is particularly important when designing critical components or systems whose failure can foreseeably result in situations that could adversely affect health or safety. In designing such critical devices, equipment or machinery, careful consideration should be given to amongst other things, their safety design, fail-safe design, back-up and redundancy systems, and diffusion design.
6. The products listed in the catalog may not be appropriate for use in certain equipment where reliability is critical or where the products may be subjected to extreme conditions. You should consult our sales office before using the products in any of the following types of equipment.

Aerospace Equipment
Equipment Used in the Deep Sea
Power Generator Control Equipment (Nuclear, Steam, Hydraulic)
Life Maintenance Medical Equipment
Fire Alarm/Intruder Detector
Vehicle Control Equipment (airplane, railroad, ship, etc.)
Various Safety devices
7. New JRC's products have been designed and tested to function within controlled environmental conditions. Do not use products under conditions that deviate from methods or applications specified in this catalog. Failure to employ New JRC products in the proper applications can lead to deterioration, destruction or failure of the products. New JRC shall not be responsible for any bodily injury, fires or accident, property damage or any consequential damages resulting from misuse or misapplication of its products. Products are sold without warranty of any kind, either express or implied, including but not limited to any implied warranty of merchantability or fitness for a particular purpose.
8. Warning for handling Gallium and Arsenic (GaAs) Products (Applying to GaAs MMIC, Photo Reflector). This Products uses Gallium (Ga) and Arsenic (As) which are specified as poisonous chemicals by law. For the prevention of a hazard, do not burn, destroy, or process chemically to make them as gas or power. When the product is disposed, please follow the related regulation and do not mix this with general industrial waste or household waste.
9. The product specifications and descriptions listed in this catalog are subject to change at any time, without notice.

