

Surface Mount Aluminum Electrolytic Capacitors NACE Series

FEATURES

- CYLINDRICAL V-CHIP CONSTRUCTION
- LOW COST, GENERAL PURPOSE, 2000 HOURS AT 85°C
- NEW EXPANDED CV RANGE (up to 6800µF)
- ANTI-SOLVENT (2 MINUTES)
- DESIGNED FOR AUTOMATIC MOUNTING AND REFLOW SOLDERING



**RoHS
Compliant**

includes all homogeneous materials

*See Part Number System for Details

CHARACTERISTICS

Rated Voltage Range	4.0 ~ 100Vdc
Rated Capacitance Range	0.47 ~ 6,800µF
Operating Temp. Range	-40°C ~ +85°C
Capacitance Tolerance	±20% (M)
Max. Leakage Current After 2 Minutes @ 20°C	0.01CV or 3µA whichever is greater

Tan δ @120Hz/20°C	W.V. (Vdc)	4.0	6.3	10	16	25	35	50	63	100	
	4 ~ 6.3mm Dia.	0.35	0.26	0.20	0.16	0.14	0.12	0.10	0.10	0.10	
	8x6.5mm Dia.	-	0.35	0.26	0.20	0.16	0.14	0.12	-	0.10	
	8mm Dia. ~ up	C≤1000µF	0.40	0.30	0.24	0.20	0.16	0.14	0.12	0.12	0.10
		C=1500µF	-	0.30	-	0.20	-	0.14	-	-	-
		C=2200µF	-	-	0.26	-	0.18	-	-	-	-
		C=3300µF	-	0.34	-	0.24	-	-	-	-	-
	C=4700µF	-	-	0.30	-	-	-	-	-	-	
	C=6800µF	-	0.40	-	-	-	-	-	-	-	
Low Temperature Stability Impedance Ratio @ 120Hz	W.V. (Vdc)	4.0	6.3	10	16	25	35	50	63	100	
	Z-25°C/Z+20°C	7	4	3	2	2	2	2	2	2	
	Z-40°C/Z+20°C	15	8	6	4	4	3	3	3	3	
Load Life Test 85°C 2,000 Hours	Capacitance Change	Within ± 25% of initial measured value									
	Tan δ	Less than 200% of specified max. value									
	Leakage Current	Less than specified max. value									

PART NUMBER SYSTEM

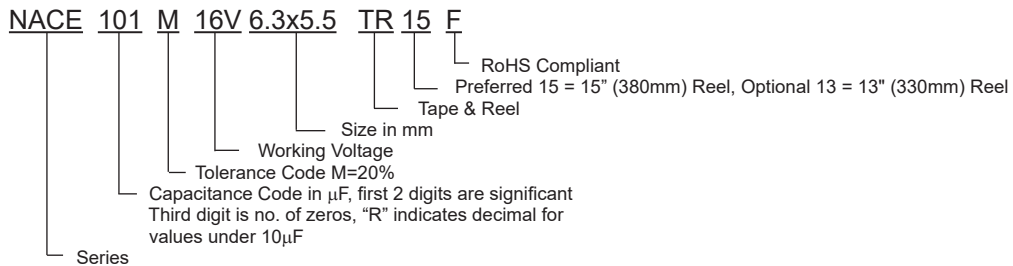

PRECAUTIONS

Please review the notes on correct use, safety and precautions found at <https://www.niccomp.com/resource/files/aluminum/AlumAppInfoCautions.pdf>
 If in doubt or uncertainty, please review your specific application - process details with NIC's technical support personnel: tpmg@niccomp.com



Surface Mount Aluminum Electrolytic Capacitors NACE Series

STANDARD PRODUCTS, SPECIFICATIONS AND CASE SIZE TABLE D ϕ xL (mm)

NIC Part Number	Cap. (μ F)	W.V. (Vdc)	Dissipation Factor (Tan δ)	Max. Ripple current (mA) @ +85°C/120Hz	Max. ESR (Ω) @ +20°C/120Hz	Load Life Hours @ +85°C	
NACE330M4V4X5.5TR15F	33	4	0.35	26	17.6	2,000	
NACE470M4V4X5.5TR15F	47		0.35	34	12.4	2,000	
NACE101M4V5X5.5TR15F	100		0.35	61	5.80	2,000	
NACE151M4V6.3X5.5TR15F	150		0.35	74	3.87	2,000	
NACE221M4V6.3X5.5TR15F	220		0.35	82	2.64	2,000	
NACE331M4V6.3X6.3TR15F	330		0.35	102	1.76	2,000	
NACE471M4V6.3X8TR15F	470		0.35	150	1.42	2,000	
NACE102M4V10X8TR15F	1000		0.40	330	0.67	2,000	
NACE220M6.3V4X5.5TR15F	22	6.3	0.26	31	19.6	2,000	
NACE330M6.3V5X5.5TR15F	33		0.26	39	13.1	2,000	
NACE470M6.3V5X5.5TR15F	47		0.26	47	9.17	2,000	
NACE101M6.3V6.3X5.5TR15F	100		0.26	71	4.31	2,000	
NACE151M6.3V6.3X5.5TR15F	150		0.26	78	2.88	2,000	
NACE221M6.3V6.3X6.3TR15F	220		0.26	95	1.96	2,000	
NACE331M6.3V6.3X8TR15F	330		0.26	150	1.31	2,000	
NACE331M6.3V8X6.5TR15F	330		0.35	300	1.76	2,000	
NACE471M6.3V8X10.5TR15F	470		0.30	300	1.06	2,000	
NACE681M6.3V10X8TR15F	680		0.30	300	0.73	2,000	
NACE102M6.3V8X10.5TR15F	1000		0.30	330	0.50	2,000	
NACE152M6.3V10X10.5TR15F	1500		0.30	450	0.35	2,000	
NACE332M6.3V12.5X14TR15F	3300		0.34	750	0.17	2,000	
NACE682M6.3V16X17TR15F	6800		0.40	1330	0.10	2,000	
NACE220M10V5X5.5TR15F	22		10	0.20	35	15.1	2,000
NACE330M10V5X5.5TR15F	33			0.20	43	10.1	2,000
NACE470M10V6.3X5.5TR15F	47	0.20		59	7.06	2,000	
NACE680M10V6.3X5.5TR15F	68	0.20		66	4.88	2,000	
NACE101M10V6.3X5.5TR15F	100	0.20		76	3.32	2,000	
NACE151M10V6.3X6.3TR15F	150	0.20		88	2.21	2,000	
NACE221M10V6.3X8TR15F	220	0.20		150	1.51	2,000	
NACE221M10V8X6.5TR15F	220	0.26		250	1.99	2,000	
NACE331M10V8X10.5TR15F	330	0.24		280	1.21	2,000	
NACE471M10V8X10.5TR15F	470	0.24		300	0.85	2,000	
NACE471M10V10X8TR15F	470	0.24		300	0.85	2,000	
NACE102M10V10X10.5TR15F	1000	0.24		450	0.40	2,000	
NACE222M10V12.5X14TR15F	2200	0.26		730	0.24	2,000	
NACE472M10V16X17TR15F	4700	0.30		1260	0.13	2,000	
NACE100M16V4X5.5TR15F	10	16		0.16	25	26.5	2,000
NACE220M16V5X5.5TR15F	22			0.16	39	12.1	2,000
NACE330M16V6.3X5.5TR15F	33		0.16	57	8.04	2,000	
NACE470M16V6.3X5.5TR15F	47		0.16	68	5.65	2,000	
NACE680M16V6.3X5.5TR15F	68		0.16	75	3.91	2,000	
NACE101M16V6.3X5.5TR15F	100		0.16	86	2.66	2,000	
NACE101M16V8X6.5TR15F	100		0.20	200	3.32	2,000	
NACE151M16V6.3X8TR15F	150		0.16	135	1.77	2,000	
NACE221M16V6.3X8TR15F	220		0.16	150	1.21	2,000	
NACE331M16V8X10.5TR15F	330		0.20	280	1.01	2,000	
NACE331M16V10X8TR15F	330		0.20	280	1.01	2,000	
NACE471M16V8X10.5TR15F	470		0.20	330	0.71	2,000	
NACE681M16V10X10.5TR15F	680		0.20	450	0.49	2,000	
NACE152M16V12.5X14TR15F	1500		0.20	710	0.24	2,000	
NACE332M16V16X17TR15F	3300		0.24	1200	0.12	2,000	

Contact NIC regarding availability of optional 13" (330mm) reels

RIPPLE CURRENT FREQUENCY CORRECTION FACTOR

Frequency Hz	100<f \le 1K	1K<f \le 10K	10K< f \le 100K	f \ge 100K
C \le 4.7 μ F	1.0	1.3	1.5	1.8
4.7 μ F<C \le 33 μ F	1.0	1.2	1.3	1.45
C>33 μ F	1.0	1.1	1.2	1.3

Surface Mount Aluminum Electrolytic Capacitors NACE Series

STANDARD PRODUCTS, SPECIFICATIONS AND CASE SIZE TABLE DφxL (mm)

NIC Part Number	Cap. (μF)	W.V. (Vdc)	Dissipation Factor (Tan δ)	Max. Ripple current (mA) @ +85°C/120Hz	Max. ESR (Ω) @ +20°C/120Hz	Load Life Hours @ +85°C
NACE4R7M25V4X5.5TR15F	4.7	25	0.14	19	49.4	2,000
NACE100M25V5X5.5TR15F	10		0.14	28	23.2	2,000
NACE220M25V6.3X5.5TR15F	22		0.14	52	10.6	2,000
NACE330M25V6.3X5.5TR15F	33		0.14	63	7.04	2,000
NACE470M25V6.3X6.3TR15F	47		0.14	68	4.94	2,000
NACE680M25V6.3X6.3TR15F	68		0.14	80	3.41	2,000
NACE101M25V6.3X8TR15F	100		0.14	130	2.32	2,000
NACE101M25V8X6.5TR15F	100		0.16	91	2.65	2,000
NACE151M25V8X10.5TR15F	150		0.16	200	1.77	2,000
NACE221M25V8X10.5TR15F	220		0.16	250	1.21	2,000
NACE221M25V10X8TR15F	220		0.16	250	1.21	2,000
NACE331M25V8X10.5TR15F	330		0.16	310	0.80	2,000
NACE471M25V10X10.5TR15F	470		0.16	430	0.56	2,000
NACE102M25V12.5X14TR15F	1000		0.16	660	0.27	2,000
NACE222M25V16X17TR15F	2200		0.18	1150	0.14	2,000
NACE4R7M35V4X5.5TR15F	4.7	35	0.12	20	42.3	2,000
NACE100M35V5X5.5TR15F	10		0.12	30	19.9	2,000
NACE220M35V6.3X5.5TR15F	22		0.12	54	9.05	2,000
NACE330M35V6.3X6.3TR15F	33		0.12	60	6.04	2,000
NACE330M35V8X6.5TR15F	33		0.14	130	7.04	2,000
NACE470M35V6.3X6.3TR15F	47		0.12	70	4.24	2,000
NACE470M35V8X6.5TR15F	47		0.14	165	4.95	2,000
NACE680M35V6.3X8TR15F	68		0.12	110	2.93	2,000
NACE101M35V6.3X8TR15F	100		0.12	130	1.99	2,000
NACE151M35V8X10.5TR15F	150		0.14	220	1.55	2,000
NACE151M35V10X8TR15F	150		0.14	220	1.55	2,000
NACE221M35V8X10.5TR15F	220		0.14	270	1.06	2,000
NACE331M35V10X10.5TR15F	330		0.14	340	0.71	2,000
NACE471M35V12.5X14TR15F	470		0.14	590	0.49	2,000
NACE681M35V12.5X14TR15F	680		0.14	610	0.34	2,000
NACE152M35V16X17TR15F	1500	0.14	1060	0.17	2,000	
NACER47M50V4X5.5TR15F	0.47	50	0.10	5	353	2,000
NACE1R0M50V4X5.5TR15F	1.0		0.10	10	166	2,000
NACE2R2M50V4X5.5TR15F	2.2		0.10	15	75.4	2,000
NACE3R3M50V4X5.5TR15F	3.3		0.10	18	50.3	2,000
NACE4R7M50V5X5.5TR15F	4.7		0.10	23	35.3	2,000
NACE100M50V6.3X5.5TR15F	10		0.10	34	16.6	2,000
NACE220M50V6.3X6.3TR15F	22		0.10	60	7.54	2,000
NACE220M50V8X6.5TR15F	22		0.12	120	9.05	2,000
NACE330M50V6.3X8TR15F	33		0.10	85	5.03	2,000
NACE330M50V8X6.5TR15F	33		0.12	65	6.04	2,000
NACE470M50V6.3X8TR15F	47		0.10	90	3.53	2,000
NACE680M50V8X10.5TR15F	68		0.12	120	2.93	2,000
NACE820M50V10X8TR15F	82		0.12	200	2.44	2,000
NACE101M50V8X10.5TR15F	100		0.12	200	1.99	2,000
NACE221M50V10X10.5TR15F	220		0.12	320	0.91	2,000
NACE331M50V12.5X14TR15F	330	0.12	520	0.60	2,000	
NACE391M50V12.5X14TR15F	390	0.12	550	0.51	2,000	
NACE471M50V16X17TR15F	470	0.12	925	0.43	2,000	
NACE102M50V16X17TR15F	1000	0.12	940	0.20	2,000	

Contact NIC regarding availability of optional 13" (330mm) reels

Surface Mount Aluminum Electrolytic Capacitors NACE Series

STANDARD PRODUCTS, SPECIFICATIONS AND CASE SIZE TABLE DφxL (mm)

NIC Part Number	Cap. (μF)	W.V. (Vdc)	Dissipation Factor (Tan δ)	Max. Ripple current (mA) @ +85°C/120Hz	Max. ESR (Ω) @ +20°C/120Hz	Load Life Hours @ +85°C
NACER47M63V4X5.5TR15F	0.47	63	0.10	5	353	2,000
NACE1R0M63V4X5.5TR15F	1.0		0.10	10	166	2,000
NACE2R2M63V4X5.5TR15F	2.2		0.10	15	75.4	2,000
NACE3R3M63V5X5.5TR15F	3.3		0.10	20	50.3	2,000
NACE4R7M63V5X5.5TR15F	4.7		0.10	23	35.3	2,000
NACE100M63V6.3X5.5TR15F	10		0.10	34	16.6	2,000
NACE220M63V6.3X8TR15F	22		0.10	70	7.54	2,000
NACE330M63V8X10.5TR15F	33		0.12	160	6.04	2,000
NACE470M63V8X10.5TR15F	47		0.12	170	4.24	2,000
NACE680M63V8X10.5TR15F	68		0.12	180	2.93	2,000
NACE101M63V10X10.5TR15F	100		0.12	280	1.99	2,000
NACE221M63V12.5X14TR15F	220		0.12	410	0.91	2,000
NACE471M63V16X17TR15F	470		0.12	700	0.43	2,000
NACE1R0M100V4X6.3TR15F	1.0		100	0.10	10	166
NACE2R2M100V6.3X6.3TR15F	2.2	0.10		20	75.4	2,000
NACE3R3M100V6.3X6.3TR15F	3.3	0.10		28	50.3	2,000
NACE3R3M100V8X6.5TR15F	3.3	0.10		50	50.3	2,000
NACE4R7M100V6.3X6.3TR15F	4.7	0.10		35	35.3	2,000
NACE100M100V6.3X8TR15F	10	0.10		50	16.6	2,000
NACE220M100V8X10.5TR15F	22	0.10		120	7.54	2,000
NACE330M100V10X10.5TR15F	33	0.10		190	5.03	2,000
NACE470M100V12.5X14TR15F	47	0.10		330	3.53	2,000
NACE680M100V12.5X14TR15F	68	0.10		350	2.44	2,000
NACE101M100V16X17TR15F	100	0.10		550	1.66	2,000
NACE151M100V16X17TR15F	150	0.10		560	1.11	2,000

Contact NIC regarding availability of optional 13" (330mm) reels

DIMENSIONS (mm)

Case Size	Dφ ±0.5	L max.	A ±0.2	B ±0.2	l ±0.3	W	(P)
4 x 5.5	4.0	5.5	4.3	4.3	2.0	0.5 ~ 0.8	1.0
4 x 6.3	4.0	6.3	4.3	4.3	2.0	0.5 ~ 0.8	1.0
5 x 5.5	5.0	5.5	5.3	5.3	2.3	0.5 ~ 0.8	1.4
6.3 x 5.5	6.3	5.5	6.6	6.6	2.5	0.5 ~ 0.8	2.2
6.3 x 6.3	6.3	6.3	6.6	6.6	2.5	0.5 ~ 0.8	2.2
6.3 x 8	6.3	8.0	6.6	6.6	2.5	0.5 ~ 0.8	2.2
8 x 6.5	8.0	6.5	8.3	8.3	3.4	0.5 ~ 0.8	2.2
8 X 10.5	8.0	10.5	8.3	8.3	2.9	0.7 ~ 1.1	3.2
10 x 8	10.0	8.0	10.3	10.3	3.2	0.7 ~ 1.4	4.6
10 x 10.5	10.0	10.5	10.3	10.3	3.2	0.7 ~ 1.4	4.6
12.5 x 14	12.5	14.0	12.8	12.8	4.5	1.0 ~ 1.4	4.6
16 x 17	16.0	17.0	16.3	16.3	5.0	1.7 ~ 2.1	7.0

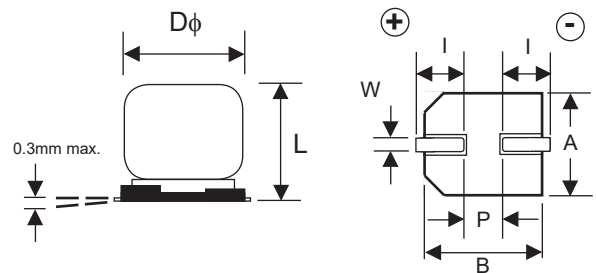

RECOMMENDED LAND PATTERN DIMENSIONS (mm)

Case Size	a	b	c
4 φ	1.0	2.6	1.8
5 φ	1.4	3.0	1.8
6.3 φ	1.8	3.6	1.8
8 φ	2.8	4.1	2.1
10 φ	4.3	4.4	2.5
12.5 φ	4.3	5.8	2.5
16 φ	6.6	6.5	5.0

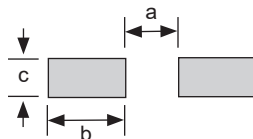

Surface Mount Aluminum Electrolytic Capacitors NACE Series

CARRIER TAPE

Case Size	A ±0.2	B ±0.2	C ±0.3	D ±0.1	P ±0.1	T ±0.2
4 x 5.5	4.7	4.7	12.0	5.5	8.0	5.8
4 x 6.3	4.7	4.7	12.0	5.5	8.0	6.4
5 x 5.5	5.7	5.7	12.0	5.5	12.0	5.8
6.3 x 5.5	7.0	7.0	16.0	7.5	12.0	5.8
6.3 x 6.3	7.0	7.0	16.0	7.5	12.0	6.5
6.3 x 8	7.0	7.0	16.0	7.5	12.0	8.2
8 x 6.5	8.7	8.7	16.0	7.5	12.0	6.8
8 X 10.5	8.7	8.7	24.0	11.5	16.0	11.1
10 x 8	10.7	10.7	24.0	11.5	16.0	8.3
10 x 10.5	10.7	10.7	24.0	11.5	16.0	11.2
12.5 x 14	13.2	13.2	32.0	14.2	24.0	14.3
16 x 17	17.5	17.5	44.0	20.2	28.0	17.3

TAPING SPECIFICATIONS (mm)

- Both Leader and Trailer tape: Minimum 40mm (1.57") empty carrier tape pockets.
- Leader tape: Approximately 20cm of cover tape at leader.
- Connection: Maximum 3 connections (slices) per reel.

CARRIER

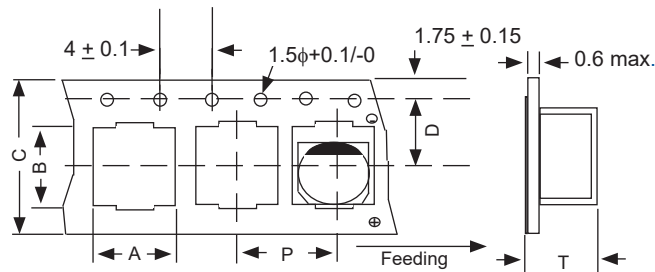

Preferred V-Chip 15" (380mm) Reels (TR15F suffix)

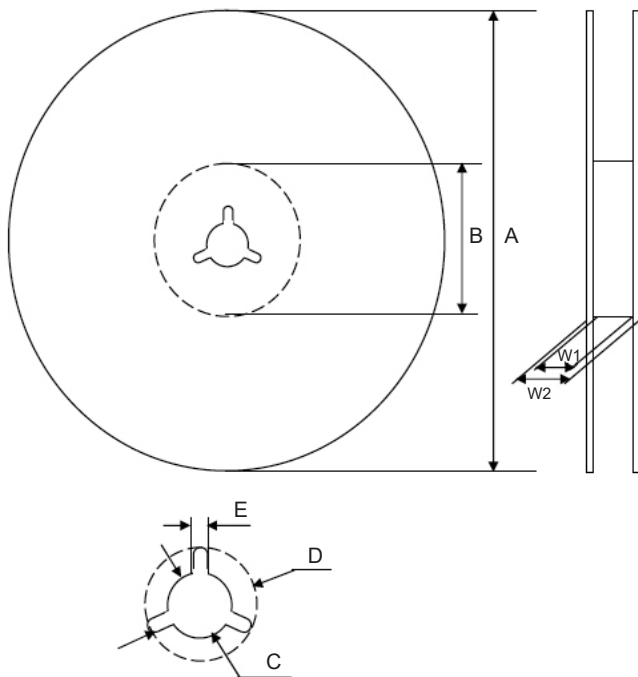

Dimensions (mm)

Case Size	Tape Width	W1	W2
4x5.5, 4x6.3	12.0	12.5 ~ 14.0	15.5 ~ 20.0
6.3x6.3, 6.3x8, 8x6.5	16.0	16.5 ~ 18.0	19.5 ~ 24.0
8x10.5, 10x8, 10x10.5	24.0	24.5 ~ 26.0	27.5 ~ 32.0
12.5x14	32.0	33.0 ~ 34.0	36.5 ~ 38.5
16x17	44.0	45.0 ~ 46.0	48.5 ~ 50.5

Case Size	Tape Width	A	B	C	D	E
4x5.5, 4x6.3	12.0	$\phi 380 \pm 2$	$\phi 80 \sim 105$	$\phi 13 \pm 0.5$	$\phi 21 \pm 1.0$	2.0 ± 0.5
6.3x6.3, 6.3x8, 8x6.5	16.0					
8x10.5, 10x8, 10x10.5	24.0					
12.5x14	32.0					
16x17	44.0					

Color
Black or Blue

Surface Mount Aluminum Electrolytic Capacitors NACE Series

Optional V-Chip 13" (330mm) Reels (TR13F suffix)

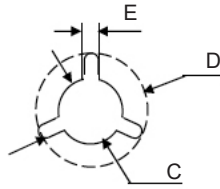
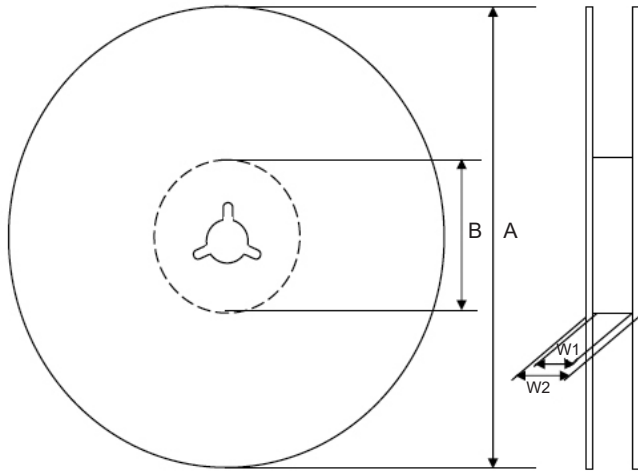

Dimensions (mm)

Case Size	Tape Width	W1	W2
4x5.5, 4x6.3, 5x5.5	12.0	12.4 ~ 14.4	15.5 ~ 20.0
6.3x5.5, 6.3x6.3, 6.3x8, 8x6.5	16.0	16.4 ~ 18.4	19.5 ~ 24.0
8x10.5, 10x8, 10x10.5	24.0	24.4 ~ 26.4	27.5 ~ 32.0

Case Size	Tape Width	A	B	C	D	E
4x5.5, 4x6.3, 5x5.5	12.0	$\phi 330 \pm 2.0$	$\phi 50 \sim 105$	$\phi 13 \pm 0.5$	$\phi 21 \pm 1.0$	2.0 ± 0.5
6.3x5.5, 6.3x6.3, 6.3x8, 8x6.5	16.0					
8x10.5, 10x8, 10x10.5	24.0					

Color
Black or Blue

Case Size	Quantity Per Reel	
	13" (330mm) Reel	15" (380mm) Reel
4x5.5	1,500 pcs	2,000 pcs
4x6.3	1,200 pcs	2,000 pcs
5x5.5	1,000 pcs	1,000 pcs
6.3x5.5	1,000 pcs	1,000 pcs
6.3x6.3	800 pcs	1,000 pcs
6.3x8	500 pcs	900 pcs
8x6.5	800 pcs	1,000 pcs
8x10.5	300 pcs	500 pcs
10x8	400 pcs	500 pcs
10x10.5	300 pcs	500 pcs
12.5x14	N/A	250 pcs
16x17	N/A	200 pcs

REFLOW TEMPERATURES & DURATIONS

Voltage Rating	Diameter	Peak Temperature (Within 5 Sec.)	Time above 200°C	Time above 217°C	Time above 230°C
4V ~ 63V	φ4 ~ 6.3	+250°C	70 sec. max.	60 sec. max.	40 sec. max.
	φ8	+245°C	60 sec. max.	50 sec. max.	30 sec. max.
	φ10, 12.5	+240°C	50 sec. max.	40 sec. max.	20 sec. max.
	φ16	+235°C	50 sec. max.	30 sec. max.	15 sec. max.
100V	φ4 ~ 6.3	+250°C	60 sec. max.	50 sec. max.	40 sec. max.
	φ8	+240°C	60 sec. max.	40 sec. max.	30 sec. max.
	φ10	+240°C	50 sec. max.	30 sec. max.	20 sec. max.
	φ12.5	+235°C	50 sec. max.	30 sec. max.	20 sec. max.
	φ16	+235°C	45 sec. max.	20 sec. max.	10 sec. max.

1. Capacitors can withstand two (2) reflows under the above conditions.
2. The second reflow shall be at least one hour after natural cool to room temperature has occurred.

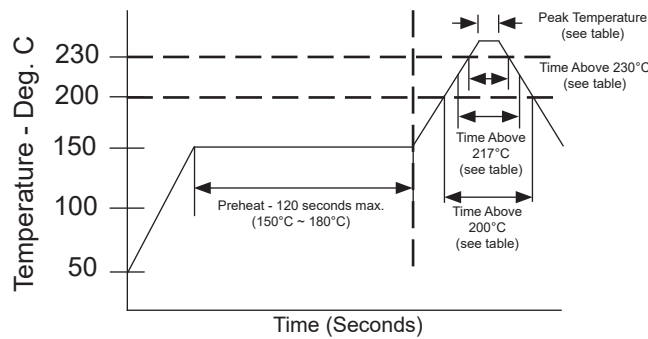

Review & Compare Reflow Soldering Heat Limits
 V-chip SMT Aluminum Electrolytic Capacitors
www.niccomp.com/RSL