

Coaxial

Precision Fixed Attenuator BW-Kx-2W44+ Series

50Ω 2W 3, 6, 10 and 20 dB DC to 40 GHz

The Big Deal

- Extremely wideband, DC to 40 GHz
- K 2.92 mm Female - 2.92 mm Male
- Outstanding attenuation flatness
- Excellent VSWR, 1.20 typ.



CASE STYLE: FF1653

Product Overview

The BW-Kx-2W44+ series of precision fixed attenuators achieves extremely wide frequency range with excellent flatness of attenuation. Available in a variety of attenuation values for different requirements, these units support a broad range of system and testing applications. Precise performance, excellent VSWR (1.2:1 typ.) and rugged construction make these models ideal solutions for systems requiring precise attenuation across very wide frequency range.

Key Features

Feature	Advantages
Extremely wideband, DC to 40 GHz	Ideal for an exceptionally wide variety of applications.
Excellent VSWR, 1.20 typ.	Efficient power utilization with low power reflected back to source.
Outstanding attenuation flatness	Provides precise, consistent attenuation across the entire frequency band, ideal for broadband and multi-band usage.
Passivated stainless steel connectors	Rugged construction withstands harsh environmental conditions for high reliability and long life of use.

Notes

- A. Performance and quality attributes and conditions not expressly stated in this specification document are intended to be excluded and do not form a part of this specification document.
B. Electrical specifications and performance data contained in this specification document are based on Mini-Circuit's applicable established test performance criteria and measurement instructions.
C. The parts covered by this specification document are subject to Mini-Circuits standard limited warranty and terms and conditions (collectively, "Standard Terms"); Purchasers of this part are entitled to the rights and benefits contained therein. For a full statement of the Standard Terms and the exclusive rights and remedies thereunder, please visit Mini-Circuits' website at www.minicircuits.com/MCLStore/terms.jsp



Precision Fixed Attenuator

BW-K6-2W44+

50Ω 2W 6dB DC to 40 GHz

Maximum Ratings

Operating Temperature	-55°C to 100°C**
Storage Temperature	-55°C to 100°C

**with mated connectors. Unmated, 85°C max.
Permanent damage may occur if any of these limits are exceeded.



Generic photo used for illustration purposes only

CASE STYLE: FF1653

Connectors Model
2.92mm Female - 2.92 Male BW-K6-2W44+

+RoHS Compliant

The +Suffix identifies RoHS Compliance. See our web site for RoHS Compliance methodologies and qualifications

Features

- DC to 40 GHz
- precise attenuation
- excellent VSWR, 1.20 typ.
- passivated stainless steel connectors
- can interface with SMA, K & 3.55mm connectors

Applications

- matching
- instrumentation
- test set-ups

Outline Drawing

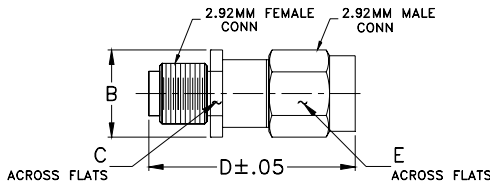

Outline Dimensions (inch/mm)

B	C	D	E	wt
.36	.312	.88	.312	grams
9.14	7.92	22.35	7.92	4.73

Electrical Specifications at 25°C

Parameter	Condition (GHz)	Min.	Typ.	Max.	Unit
Frequency Range		DC	—	40	GHz
Attenuation¹	DC - 40	—	6	—	dB
	DC - 26.5	5.5	—	6.5	
	26.5 - 37	5.2	—	6.8	
	37 - 40	5.2	—	7.2	
VSWR	DC - 18	—	1.06	1.3	:1
	18 - 26.5	—	1.09	1.4	
	26.5 - 40	—	1.50	1.5	
Input Power²	DC - 40	—	—	2	W

1. At 25°C, accuracy includes frequency and power variations. Temperature coefficient for attenuation: .0004dB/dB/°C typ.
2. Max. power at 25°C ambient, derate linearly to 0.575W at 100°C.

Typical Performance Data

Frequency (GHz)	Attenuation (dB)	VSWR (:1)
0.10	5.62	1.01
1.00	5.66	1.01
5.00	5.72	1.05
10.00	5.75	1.04
15.00	5.85	1.10
18.00	5.92	1.14
20.00	6.05	1.09
26.50	6.12	1.12
30.00	6.08	1.24
40.00	6.50	1.27

Simplified Electrical Schematic

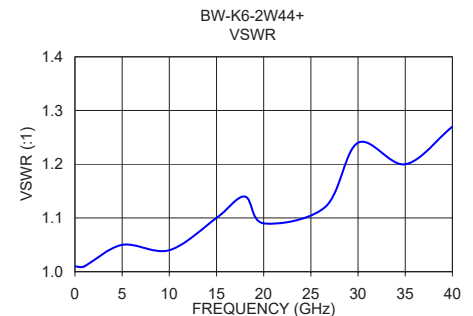
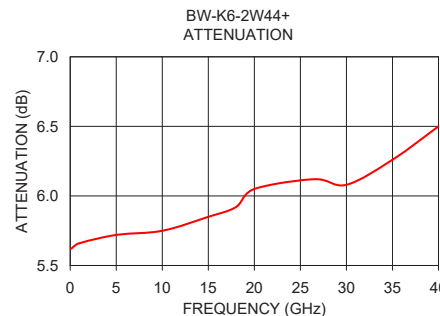
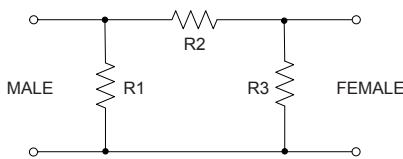

Notes

- Performance and quality attributes and conditions not expressly stated in this specification document are intended to be excluded and do not form a part of this specification document.
- Electrical specifications and performance data contained in this specification document are based on Mini-Circuit's applicable established test performance criteria and measurement instructions.
- The parts covered by this specification document are subject to Mini-Circuits standard limited warranty and terms and conditions (collectively, "Standard Terms"); Purchasers of this part are entitled to the rights and benefits contained therein. For a full statement of the Standard Terms and the exclusive rights and remedies thereunder, please visit Mini-Circuits' website at www.minicircuits.com/MCLStore/terms.jsp



Fixed Attenuator

BW-K6-2W44+

Typical Performance Data

FREQUENCY (GHz)	ATTENUATION (dB)	VSWR (:1)
0.05	5.61	1.01
0.1	5.62	1.01
0.5	5.65	1.01
1.0	5.66	1.01
1.5	5.67	1.01
2.0	5.67	1.01
2.5	5.67	1.02
3.0	5.68	1.02
3.5	5.69	1.03
4.0	5.70	1.04
4.5	5.69	1.04
5.0	5.72	1.05
5.5	5.71	1.05
6.0	5.73	1.05
6.5	5.73	1.04
7.0	5.72	1.04
8.0	5.73	1.03
9.0	5.75	1.04
10.0	5.75	1.04
11.0	5.78	1.04
12.0	5.78	1.06
13.0	5.80	1.09
14.0	5.85	1.10
15.0	5.85	1.10
16.0	5.85	1.09
17.0	5.91	1.11
18.0	5.92	1.14
19.0	5.95	1.13
20.0	6.05	1.09
21.0	6.13	1.06
22.0	6.04	1.06
23.0	6.05	1.09
24.0	6.05	1.10
25.0	6.01	1.09
26.0	5.98	1.08
27.0	6.06	1.16
28.0	6.13	1.24
29.0	6.17	1.25
30.0	6.08	1.24
31.0	6.11	1.24
32.0	6.27	1.23
33.0	6.24	1.20
34.0	6.22	1.16
35.0	6.26	1.20
36.0	6.32	1.25
37.0	6.39	1.22
38.0	6.35	1.17
39.0	6.42	1.19
40.0	6.50	1.27



Typical Performance Curves

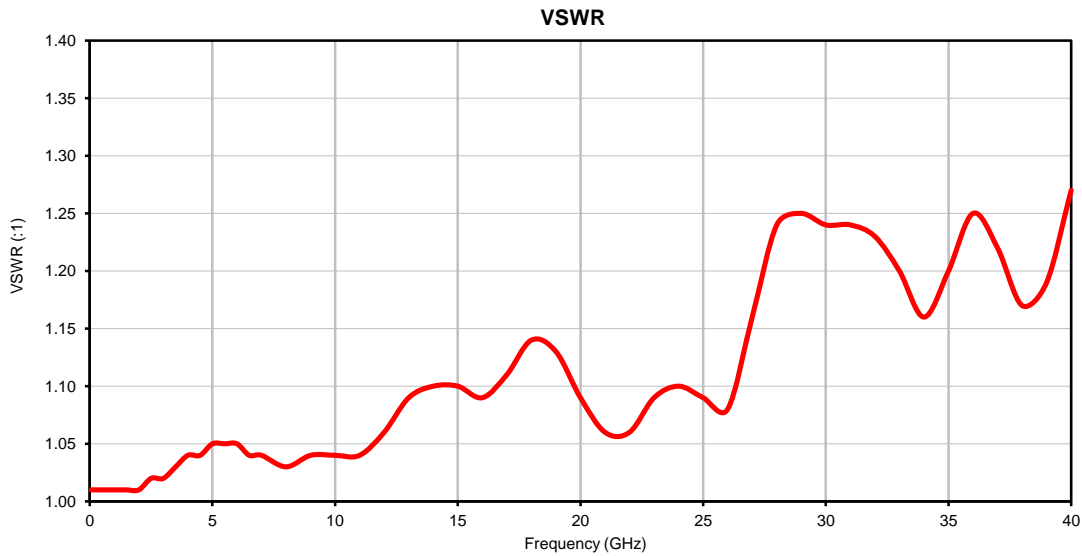
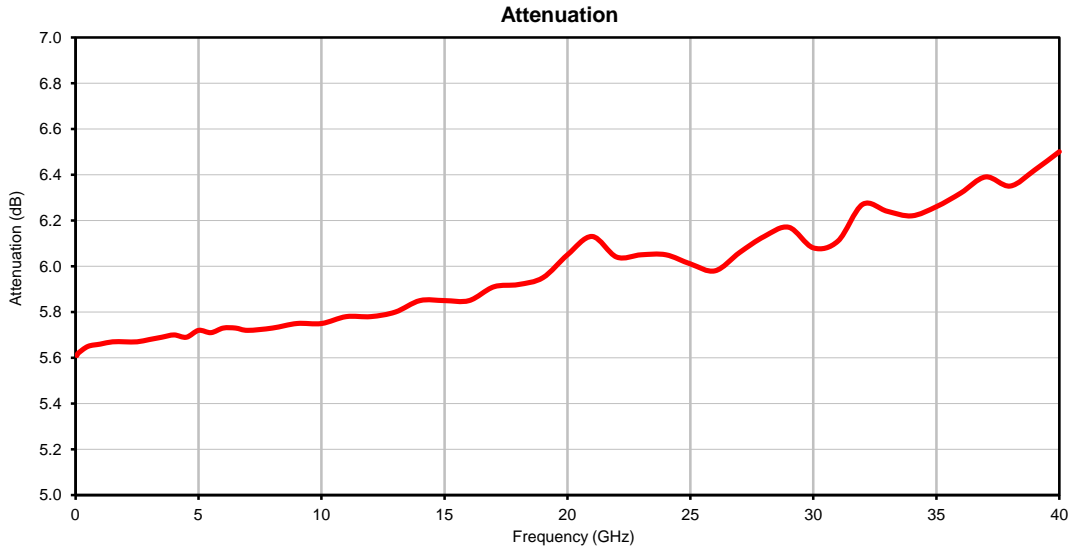

Outline Dimensions

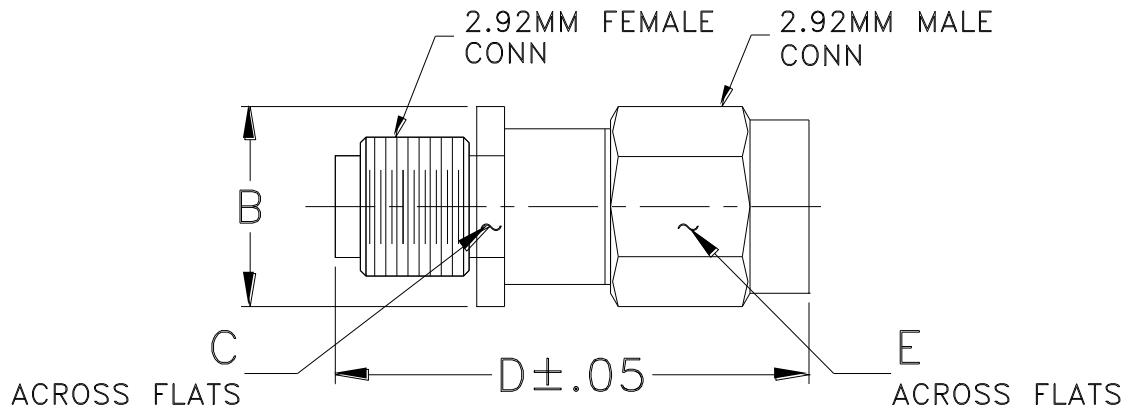

CASE #.	A	B	C	D	E	WT GRAMS
FF1653	--	.36 (9.14)	.312 (7.92)	.88 (22.35)	.312 (7.92)	4.73

Dimensions are in inches (mm). Tolerances: 2Pl. $\pm .03$; 3Pl. $\pm .015$

Notes:

1. Case material: Passivated Stainless steel.



All Mini-Circuits products are manufactured under exacting quality assurance and control standards, and are capable of meeting published specifications after being subjected to any or all of the following physical and environmental test.

Specification	Test/Inspection Condition	Reference/Spec
Operating Temperature	-55° to 100° C Ambient Environment	Individual Model Data Sheet
Storage Temperature	-55° to 100° C Ambient Environment	Individual Model Data Sheet
Barometric Pressure	100,000 Feet	MIL-STD-202, Method 105, Condition D
Thermal Shock	-55° to 125°C, 5 cycles	MIL-STD-202, Method107, Condition B