

NCV8925

3 MHz, 600 mA Step-Down DC-DC Converter

High-Efficiency, Low Ripple, Adjustable Output Voltage

The NCV8925 DC-DC buck converter is available in a space saving low profile TSOP-5 and μ UDFN6 package. The part can supply output voltages from 0.9 V to 3.3 V by an external resistor divider and is able to deliver output currents up to 600 mA. This switching regulator operates at 3.0 MHz and automatically switches between PFM and PWM modes to improve system efficiency.

Soft-start, cycle-by-cycle current limiting and thermal shutdown protection are also integrated in NCV8925.

The device is optimized for automotive applications and bring a high frequency DC-DC solution for automotive requirements.

Features

- Up to 93% Efficiency
- Allow Use of Small External Components
- Source up to 600 mA
- 3 MHz Switching Frequency
- Adjustable Output Voltage from 0.9 V to 3.3 V
- Synchronous Rectification for Higher Efficiency
- 2.7 V to 5.5 V Input Voltage Range
- Low Quiescent Current
- Shutdown Current Consumption of 0.3 μ A
- Thermal Limit Protection
- Short Circuit Protection
- All Pins are Fully ESD Protected
- These are Pb-Free Devices
- NCV Prefix for Automotive and Other Applications Requiring Site and Control Changes

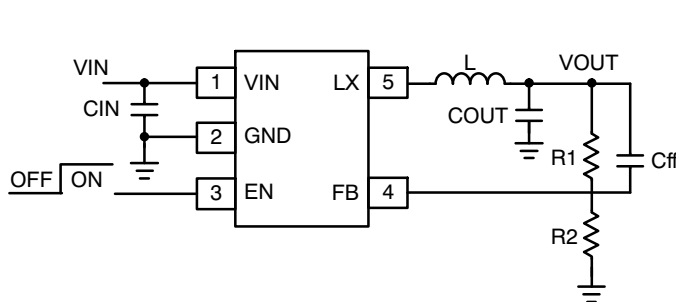

Figure 1. Typical Application - TSOP-5

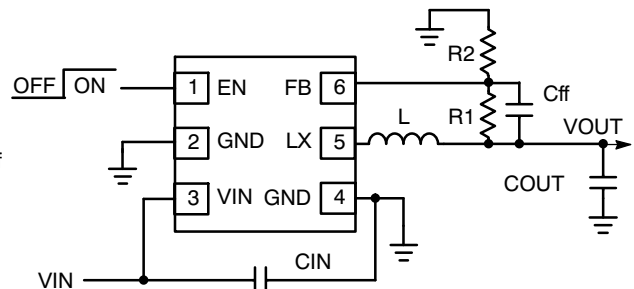

Figure 2. Typical Application - UDFN6



ON Semiconductor®

<http://onsemi.com>

MARKING DIAGRAMS



UDFN6
MU SUFFIX
CASE 517AB

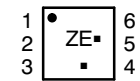

TSOP-5
SN SUFFIX
CASE 483

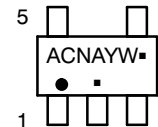

ZE,ACN= Specific Device Code
A = Assembly Location
Y = Year
W = Work Week
▪ = Pb-Free Package
(Note: Microdot may be in either location)

ORDERING INFORMATION

| Device | Package | Shipping† |
|--------------|---------------------|------------------|
| NCV8925MUTBG | UDFN6 (Pb-Free) | 3000/Tape & Reel |
| NCV8925SNT1G | TSOP-5 (Pb-Free) | 3000/Tape & Reel |

†For information on tape and reel specifications, including part orientation and tape sizes, please refer to our Tape and Reel Packaging Specification Brochure, BRD8011/D.

NCV8925

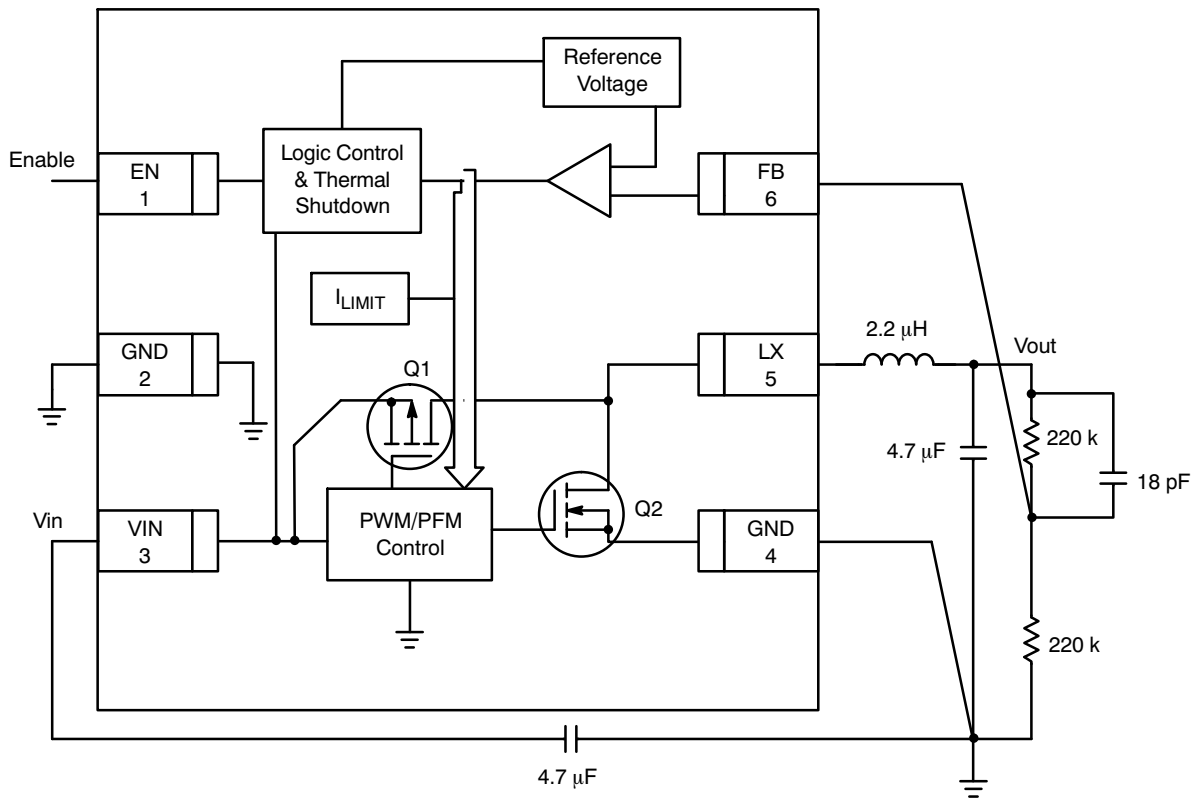

Figure 3. Simplified Block Diagram

PIN FUNCTION DESCRIPTION

| Pin TSOP-5 | Pin UDFN6 | Pin Name | Type | Description |
|------------|-----------|----------|-----------------------|--|
| 1 | 3 | VIN | Analog / Power Input | Power supply input for the PFET power stage, analog and digital blocks. The pin must be decoupled to ground by a 10 μ F ceramic capacitor. |
| 2 | 2, 4 | GND | Analog / Power Ground | This pin is the GND reference for the NFET power stage and the analog section of the IC. The pin must be connected to the system ground. |
| 3 | 1 | EN | Digital Input | Enable for switching regulators. This pin is active HIGH and is turned off by logic LOW on this pin. |
| 4 | 6 | FB | Analog Input | Feedback voltage from the output of the power supply. This is the input to the error amplifier. |
| 5 | 5 | LX | Analog Output | Connection from power MOSFETs to the inductor. |

PIN CONNECTIONS

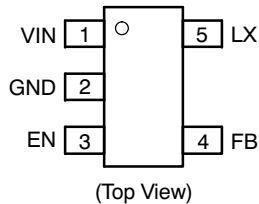

Figure 4. Pin Connections - TSOP-5

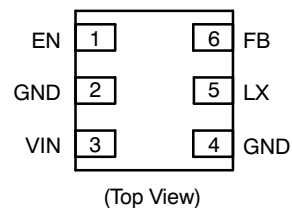

Figure 5. Pin Connections - UDFN6

MAXIMUM RATINGS

| Rating | Symbol | Value | Unit |
|---|-----------------|----------------|---------------|
| Minimum Voltage All Pins | V_{min} | -0.3 | V |
| Maximum Voltage All Pins (Note 2) | V_{max} | 7.0 | V |
| Maximum Voltage EN, FB, LX | V_{max} | $V_{IN} + 0.3$ | V |
| Thermal Resistance, Junction-to-Air (with Recommended Soldering Footprint) | $R_{\theta JA}$ | 300 220 | $^{\circ}C/W$ |
| | TSOP-5 UDFN6 | | |
| Operating Ambient Temperature Range (Notes 6 and 7) | T_A | -40 to 125 | $^{\circ}C$ |
| Storage Temperature Range | T_{stg} | -55 to 150 | $^{\circ}C$ |
| Junction Operating Temperature (Notes 6 and 7) | T_j | -40 to 150 | $^{\circ}C$ |
| Latchup Current Maximum Rating ($T_A = 85^{\circ}C$) (Note 4) Other Pins | I_{Lu} | ± 100 | mA |
| ESD Withstand Voltage (Note 3) | V_{esd} | 2.0 200 | kV V |
| Human Body Model | | | |
| Machine Model | | | |
| Moisture Sensitivity Level (Note 5) | MSL | 1 | per IPC |

Stresses exceeding Maximum Ratings may damage the device. Maximum Ratings are stress ratings only. Functional operation above the Recommended Operating Conditions is not implied. Extended exposure to stresses above the Recommended Operating Conditions may affect device reliability.

- Maximum electrical ratings are defined as those values beyond which damage to the device may occur at $T_A = 25^{\circ}C$.
- According to JEDEC standard JESD22-A108B.
- This device series contains ESD protection and exceeds the following tests:
Human Body Model (HBM) per JEDEC standard: JESD22-A114.
Machine Model (MM) per JEDEC standard: JESD22-A115.
- Latchup current maximum rating per JEDEC standard: JESD78.
- JEDEC Standard: J-STD-020A.
- In applications with high power dissipation (low V_{IN} , high I_{OUT}), special care must be paid to thermal dissipation issues. Board design considerations – thermal dissipation vias, traces or planes and PCB material – can significantly improve junction to air thermal resistance $R_{\theta JA}$ (for more information, see design and layout consideration section). Environmental conditions such as ambient temperature T_a brings thermal limitation on maximum power dissipation allowed.
The following formula gives calculation of maximum ambient temperature allowed by the application:
 $T_{a MAX} = T_{j MAX} - (R_{\theta JA} \times P_d)$
Where T_j is the junction temperature,
 P_d is the maximum power dissipated by the device (worst case of the application),
and $R_{\theta JA}$ is the junction-to-ambient thermal resistance.
- To prevent permanent thermal damages, this device include a thermal shutdown which engages at $180^{\circ}C$ (typ).

NCV8925

ELECTRICAL CHARACTERISTICS (Typical values are referenced to $T_A = +25^\circ\text{C}$, Min and Max values are referenced -40°C to $+125^\circ\text{C}$ ambient temperature, unless otherwise noted, operating conditions $V_{IN} = 3.6\text{ V}$, $V_{OUT} = 1.2\text{ V}$, unless otherwise noted.)

| Rating | Pin | | Symbol | Min | Typ | Max | Unit |
|--------|------|------|--------|-----|-----|-----|------|
| | TSOP | UDFN | | | | | |

VIN PIN

| | | | | | | | |
|---|---|---|--------------------|-----|-----|------|---------------|
| Input Voltage Range | 1 | 3 | V_{IN} | 2.7 | - | 5.5 | V |
| Quiescent Current, PFM No Switching | 1 | 3 | $I_{q\text{ ON}}$ | - | 50 | 90 | μA |
| Standby Current, EN Low | 1 | 3 | $I_{q\text{ OFF}}$ | - | 0.2 | 1.5 | μA |
| Under Voltage Lockout (V_{IN} Falling) | 1 | 3 | V_{UVLO} | 2.2 | 2.4 | 2.55 | V |

EN PIN

| | | | | | | | |
|---|---|---|-----------|-----|-----|-----|---------------|
| Positive Going Input High Voltage Threshold, EN0 Signal | 3 | 1 | V_{IH} | 1.2 | - | - | V |
| Negative Going Input High Voltage Threshold, EN0 Signal | 3 | 1 | V_{IL} | - | - | 0.4 | V |
| EN High Input Current, EN = 3.6 V | 3 | 1 | I_{ENH} | - | 2.0 | - | μA |

OUTPUT

| | | | | | | | |
|--|---|---|------------------|-----------|------------------------|----------------|------------------|
| Output Voltage Accuracy (Note 8) Ambient Temperature Overtemperature Range | | | ΔV_{OUT} | - -3.0 | ± 1.0 ± 2.0 | - ± 3.0 | % |
| Minimum Output Voltage (Note 9) | | | V_{OUT} | - | 0.9 | - | V |
| Maximum Output Voltage | | | V_{OUT} | - | 3.3 | - | V |
| Output Voltage Load Regulation Overtemperature $I_{OUT} = 100\text{ mA}$ to 600 mA | | | V_{OUT} | - | 0.0008 | - | %/mA |
| Load Transient Response, Rise/Falltime $1\ \mu\text{s}$ 10 mA to 100 mA Load Step 200 mA to 600 mA Load Step | | | V_{OUT} | - - | 50 54 | - - | mV |
| Output Voltage Line Regulation, $I_{OUT} = 100\text{ mA}$, $V_{IN} = 2.7\text{ V}$ to 5.5 V | | | V_{OUT} | - | 0.08 | - | % |
| Line Transient Response, $I_{OUT} = 100\text{ mA}$, 3.6 V to 3.0 V Line Step (Falltime=50 μs) | | | V_{OUT} | - | 2.0 | - | mV _{PP} |
| Output Voltage Ripple, $I_{OUT} = 300\text{ mA}$ (PWM Mode) | | | V_{OUT} | - | 1.0 | - | mV |
| Output Voltage Ripple, $I_{OUT} = 0\text{ mA}$ (PFM Mode) | | | V_{OUT} | - | 8.0 | - | mV |
| Peak Inductor Current | 5 | 5 | I_{LIM} | - | 1200 | - | mA |
| Oscillator Frequency | 5 | 5 | F_{OSC} | 2.4 | 3.0 | 3.6 | MHz |
| Duty Cycle | 5 | 5 | - | - | - | 100 | % |
| Soft-Start Time | | | T_{START} | - | 320 | 500 | μs |
| Thermal Shutdown Threshold | | | T_{SD} | - | 160 | - | $^\circ\text{C}$ |
| Thermal Shutdown Hysteresis | | | T_{SDH} | - | 25 | - | $^\circ\text{C}$ |

POWER SWITCHES

| | | | | | | | |
|---------------------------|--|--|-------------|---|------|---|------------------|
| P-Channel On-Resistance | | | RL_{xH} | - | 400 | - | $\text{m}\Omega$ |
| N-Channel On-Resistance | | | RL_{xL} | - | 400 | - | $\text{m}\Omega$ |
| P-Channel Leakage Current | | | I_{LeakH} | - | 0.05 | - | μA |
| N-Channel Leakage Current | | | I_{LeakL} | - | 0.01 | - | μA |

8. The overall output voltage tolerance depends upon the accuracy of the external resistor (R1, R2).

9. For $V_{OUT} = 0.9\text{ V}$, maximum input voltage do not exceed 5.2 V.

TABLE OF GRAPHS

| Typical Characteristics for Step-down Converter | | | Figure |
|---|-------------------------------------|--------------------|----------------|
| I_{STB} | Standby Current | vs. Input Voltage | 6 |
| I_q | Quiescent Current, PFM No Switching | vs. Input Voltage | 7 |
| V_{OUT} | Output Voltage Accuracy | vs. Temperature | 8, 9 |
| Eff | Efficiency | vs. Output Current | 10, 11, 12 |
| Freq | Switching Frequency | vs. Input Voltage | 13 |
| V_{OUT} | Soft-Start | vs. Time | 14 |
| V_{OUT} | Short Circuit Protection | vs. Time | 15 |
| V_{OUT} | Line Regulation | vs. Input Voltage | 16, 17 |
| V_{OUT} | Line Transient | vs. Time | 18, 19 |
| V_{OUT} | Load Regulation | vs. Output Current | 20, 21 |
| V_{OUT} | Load Transient | vs. Time | 22, 23, 25, 25 |

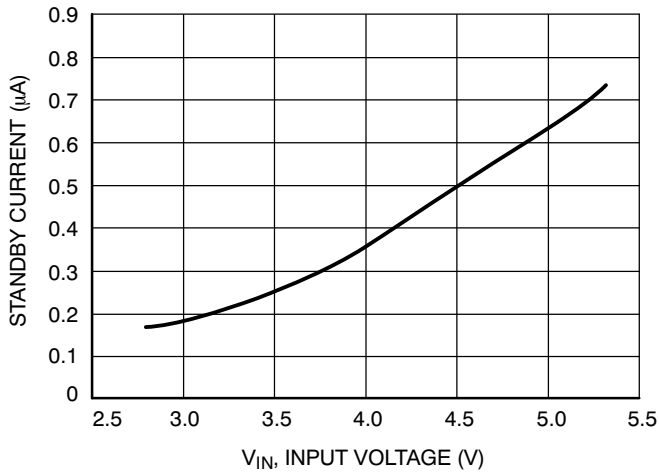

Figure 6. Shutdown Current vs. Supply Voltage

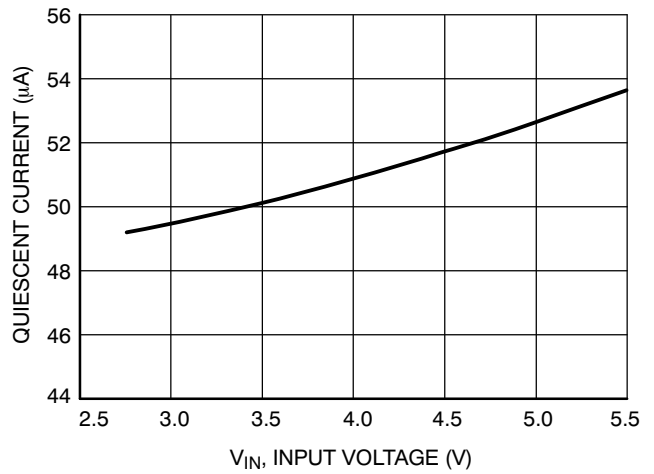

Figure 7. Quiescent Current PFM No Switching vs. Supply Voltage

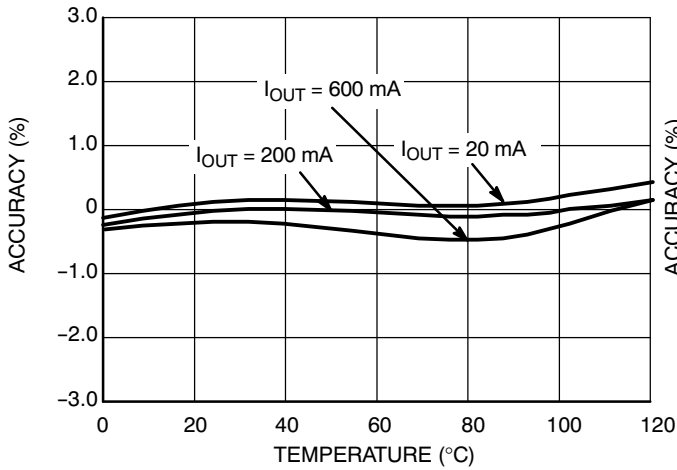

Figure 8. Output Voltage Accuracy vs. Temperature
($V_{IN} = 3.6\text{ V}$, $V_{OUT} = 1.2\text{ V}$)

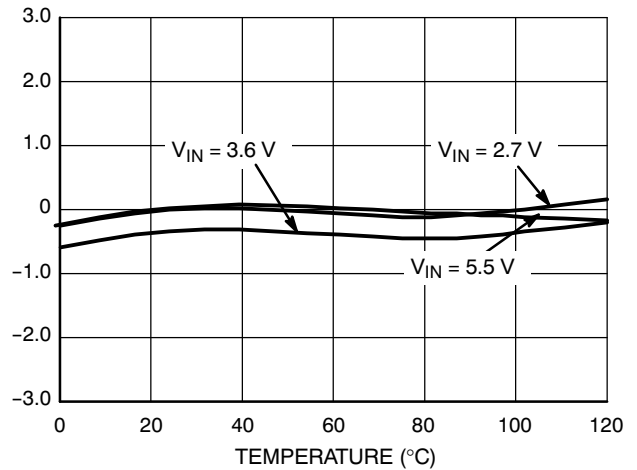

Figure 9. Output Voltage Accuracy vs. Temperature
($V_{OUT} = 1.2\text{ V}$, $I_{OUT} = 200\text{ mA}$)

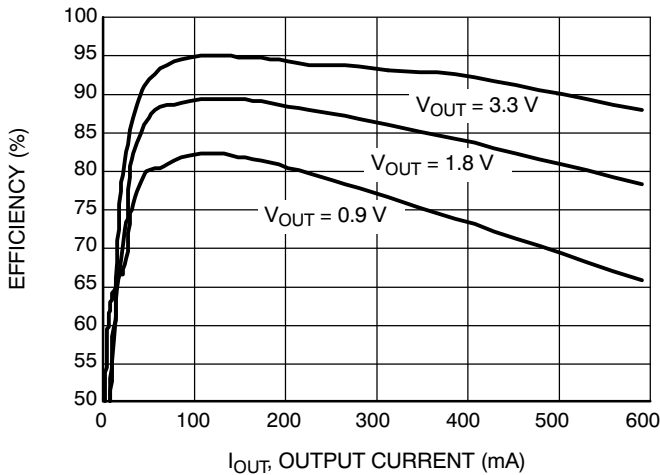

Figure 10. Efficiency vs. Output Current
($V_{IN} = 3.6\text{ V}$, $T_A = 25^\circ\text{C}$)

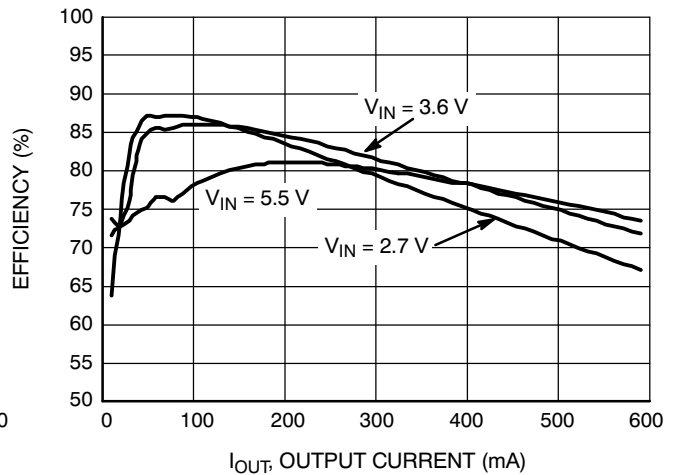

Figure 11. Efficiency vs. Output Current
($V_{OUT} = 1.2\text{ V}$, $T_A = 25^\circ\text{C}$)

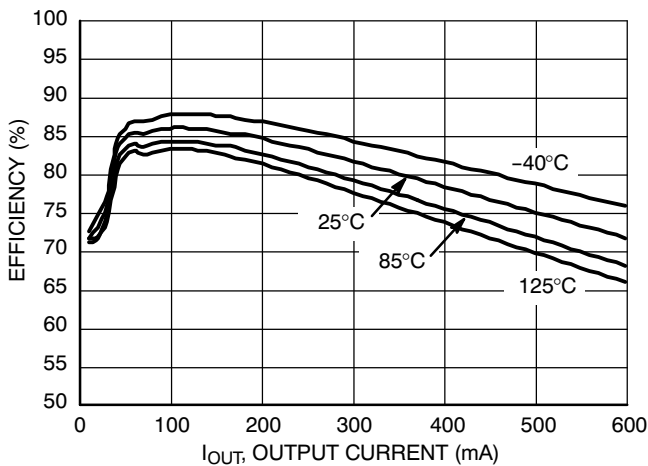

Figure 12. Efficiency vs. Output Current
($V_{IN} = 3.6\text{ V}$, $V_{OUT} = 1.2\text{ V}$)

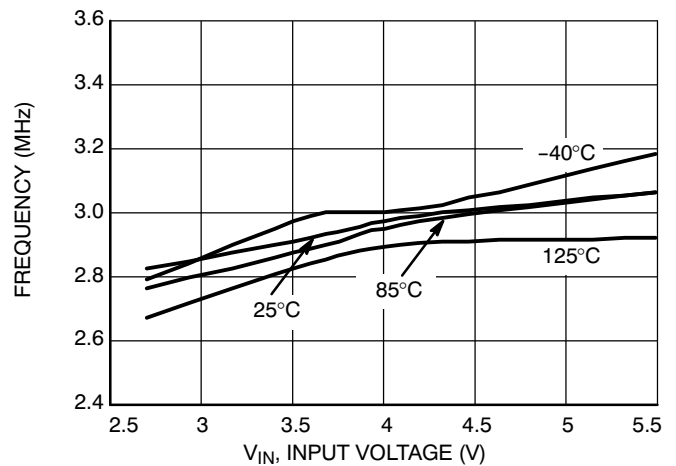

Figure 13. Switching Frequency vs. Input Voltage
($V_{OUT} = 1.2\text{ V}$, $I_{OUT} = 300\text{ mA}$)

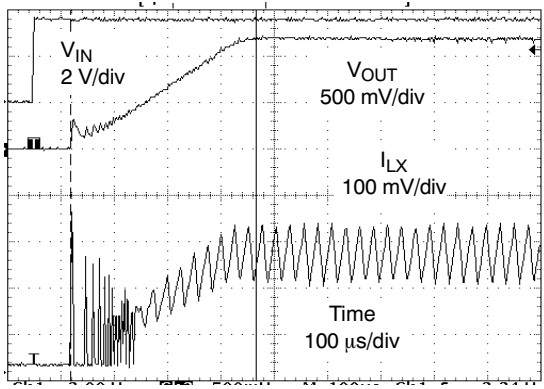

Figure 14. Typical Soft-Start
($V_{OUT} = 1.2\text{ V}$, $I_{OUT} = 250\text{ mA}$)

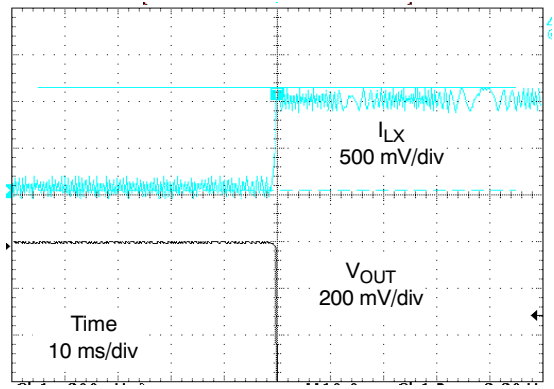

Figure 15. Short-Circuit Protection
($V_{IN} = 3.6\text{ V}$, $V_{OUT} = 1.2\text{ V}$)

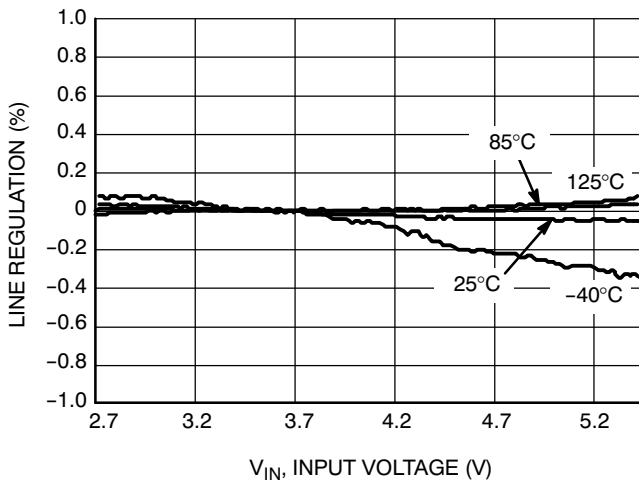

Figure 16. Line Regulation
($V_{OUT} = 1.2\text{ V}$, $I_{OUT} = 300\text{ mA}$)

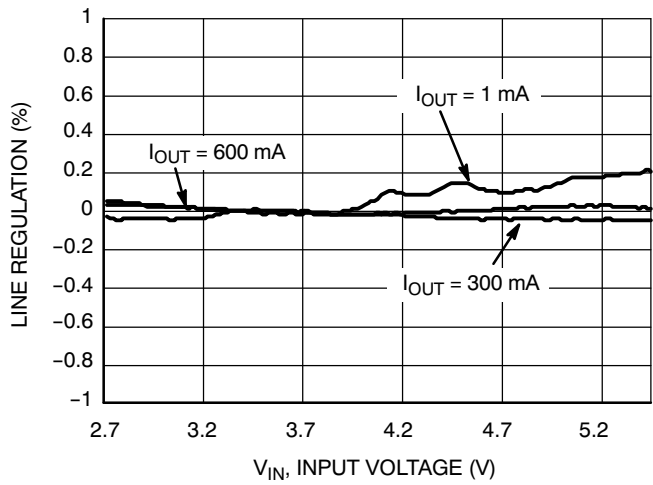

Figure 17. Line Regulation
($V_{OUT} = 1.2\text{ V}$, $T_A = 25^\circ\text{C}$)

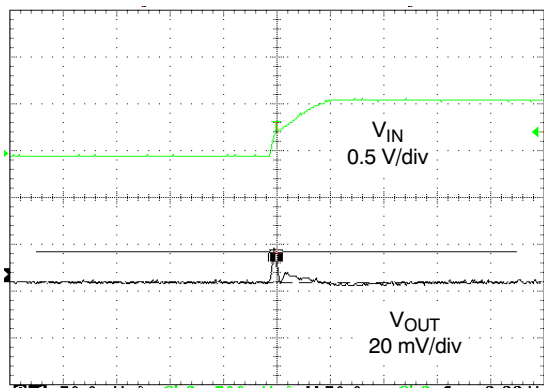

Figure 18. 3.0 V to 3.6 V Line Transient
(Risettime = $50\ \mu\text{s}$, $V_{OUT} = 1.2\text{ V}$, $I_{OUT} = 100\text{ mA}$, $T_A = 25^\circ\text{C}$)

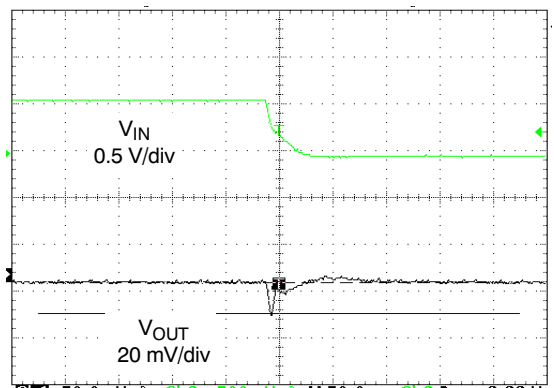

Figure 19. 3.6 V to 3.0 V Line Transient
(Risettime = $50\ \mu\text{s}$, $V_{OUT} = 1.2\text{ V}$, $I_{OUT} = 100\text{ mA}$, $T_A = 25^\circ\text{C}$)

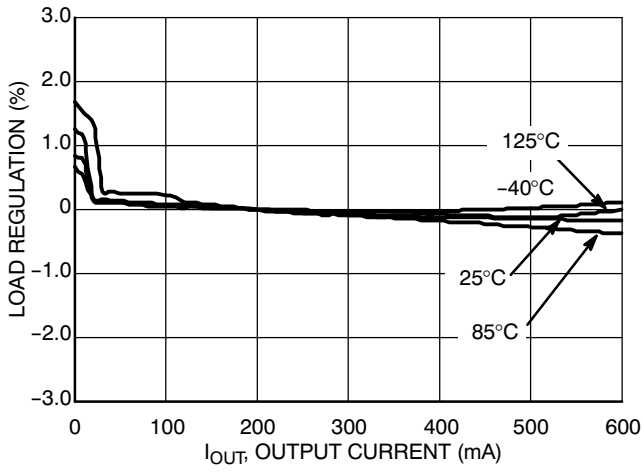

Figure 20. Load Regulation
(V_{IN} = 3.6 V, V_{OUT} = 1.2 V)

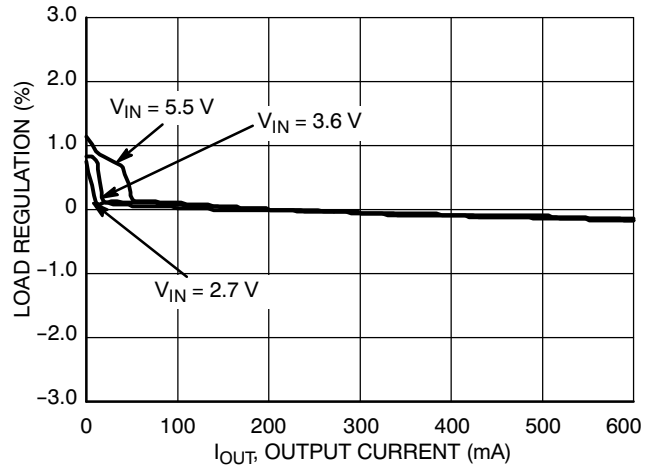

Figure 21. Load Regulation
(V_{OUT} = 1.2 V, T_A = 25°C)

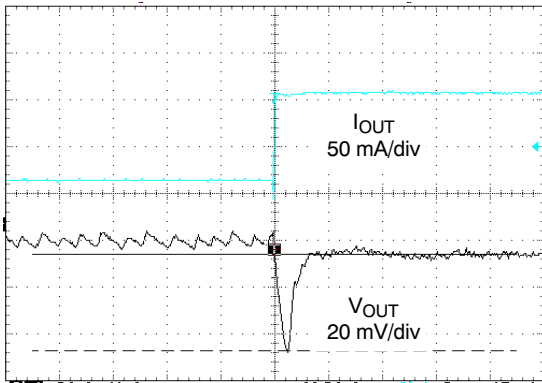

Figure 22. 10 mA to 100 mA Load Transient
(V_{IN} = 3.6 V, V_{OUT} = 1.2 V, T_A = 25°C)

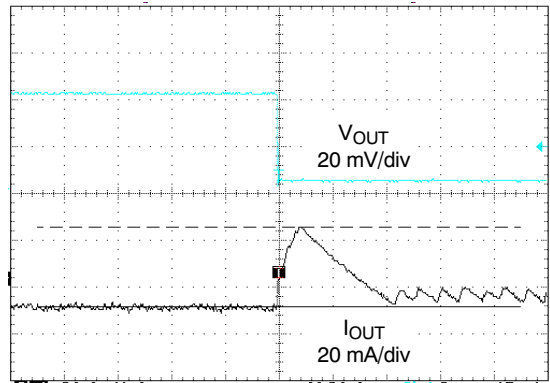

Figure 23. 100 mA to 10 mA Load Transient
(V_{IN} = 3.6 V, V_{OUT} = 1.2 V, T_A = 25°C)

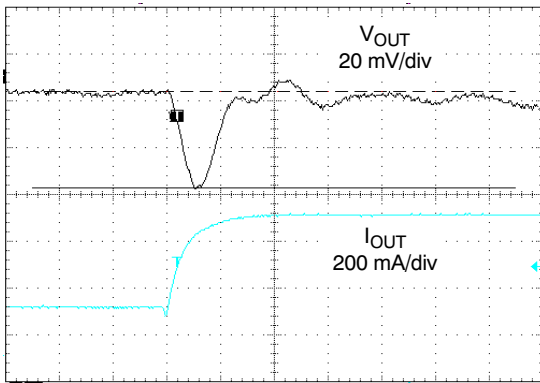

Figure 24. 200 mA to 600 mA Load Transient
(V_{IN} = 3.6 V, V_{OUT} = 1.2 V, T_A = 25°C)

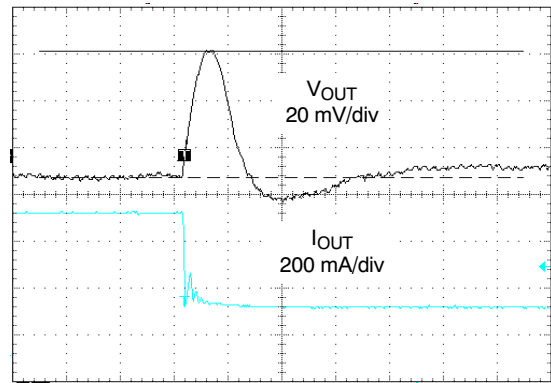

Figure 25. 600 mA to 200 mA Load Transient
(V_{IN} = 3.6 V, V_{OUT} = 1.2 V, T_A = 25°C)

DC/DC OPERATION DESCRIPTION

Detailed Description

The NCV8925 uses a constant frequency, voltage mode step-down architecture. Both the main (P-Channel MOSFET) and synchronous (N-Channel MOSFET) switches are internal.

The output voltage is set by an external resistor divider in the range of 0.9 V to 3.3 V and can source at least 600 mA.

The NCV8925 works with two modes of operation; PWM/PFM depending on the current required. In PWM mode, the device can supply voltage with a tolerance of $\pm 3\%$ and 90% efficiency or better. Lighter load currents cause the device to automatically switch into PFM mode to reduce current consumption and extended battery life.

Additional features include soft-start, undervoltage protection, current overload protection, and thermal shutdown protection. As shown in Figure 2, only six external components are required. The part uses an internal reference voltage of 0.6 V. It is recommended to keep NCV8925 in shutdown mode until the input voltage is 2.7 V or higher.

PWM Operating Mode

In this mode, the output voltage of the device is regulated by modulating the on-time pulse width of the main switch Q1 at a fixed 3 MHz frequency.

The switching of the PMOS Q1 is controlled by a flip-flop driven by the internal oscillator and a comparator that compares the error signal from an error amplifier with the sum of the sensed current signal and compensation ramp.

At the beginning of each cycle, the main switch Q1 is turned ON by the rising edge of the internal oscillator clock. The inductor current ramps up until the sum of the current sense signal and compensation ramp becomes higher than the error amplifier's voltage. Once this has occurred, the PWM comparator resets the flip-flop, Q1 is turned OFF while the synchronous switch Q2 is turned ON. Q2 replaces the external Schottky diode to reduce the conduction loss and improve the efficiency. To avoid overall power loss, a certain amount of dead time is introduced to ensure Q1 is completely turned OFF before Q2 is being turned ON.

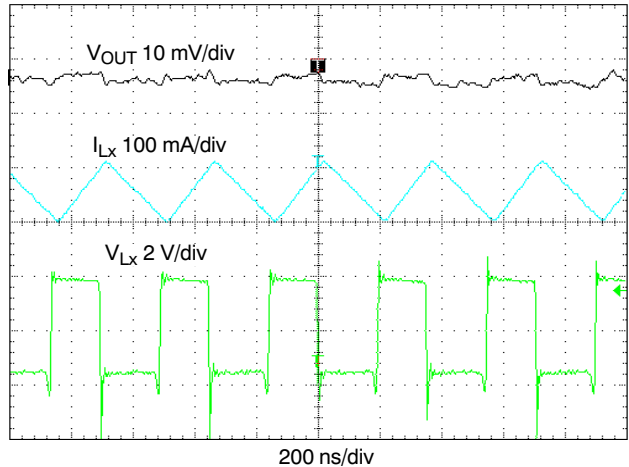

Figure 26. PWM Switching Waveform
 $(V_{IN} = 3.6 \text{ V}, V_{OUT} = 1.2 \text{ V}, I_{OUT} = 600 \text{ mA})$

PFM Operating Mode

Under light load conditions, the NCV8925 enters in low current PFM mode operation to reduce power consumption. The output regulation is implemented by pulse frequency modulation. If the output voltage drops below the threshold of PFM comparator, a new cycle will be initiated by the PFM comparator to turn on the switch Q1. Q1 remains ON during the minimum on time of the structure while Q2 is in its current source mode. The peak inductor current depends upon the drop between input and output voltage. After a short dead time delay where Q1 is switched OFF, Q2 is turned in its ON state. The negative current detector will detect when the inductor current drops below zero and sends the signal to turn Q2 to current source mode to prevent a too large deregulation of the output voltage. When the output voltage falls below the threshold of the PFM comparator, a new cycle starts immediately.

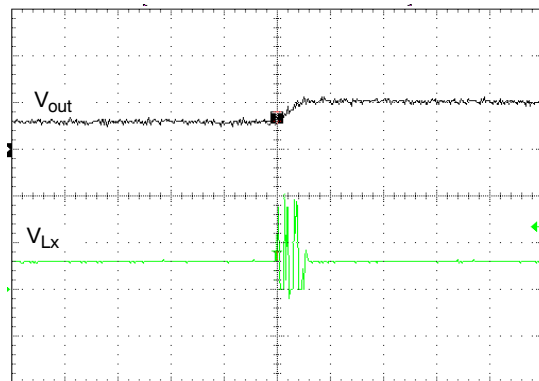

Figure 27. PFM Switching Waveforms
 $(V_{IN} = 3.6 \text{ V}, V_{OUT} = 1.2 \text{ V}, I_{OUT} = 0 \text{ mA}, \text{Temp} = 25^\circ\text{C})$

Soft-Start

The NCV8925 uses soft-start to limit the inrush current when the device is initially powered up or enabled. Soft-start is implemented by gradually increasing the reference voltage until it reaches the full reference voltage. During startup, a pulsed current source charges the internal soft-start capacitor to provide gradually increasing reference voltage. When the voltage across the capacitor ramps up to the nominal reference voltage, the pulsed current source will be switched off and the reference voltage will switch to the regular reference voltage.

Cycle-by-Cycle Current Limitation

From the block diagram, an I_{LIM} comparator is used to realize cycle-by-cycle current limit protection. The comparator compares the LX pin voltage with the reference voltage, which is biased by a constant current. If the inductor current reaches the limit, the I_{LIM} comparator detects the LX voltage falling below the reference voltage and releases the signal to turn off the switch Q1. The cycle-by-cycle current limit is set at 1200 mA (nom).

Low Dropout Operation

The NCV8925 offers a low input to output voltage difference. The NCV8925 can operate at 100% duty cycle. In this mode the PMOS (Q1) remains completely on.

The minimum input voltage to maintain regulation can be calculated as:

$$V_{IN(min)} = V_{OUT(max)} + (I_{OUT} \times (R_{DS(ON)} + R_{INDUCTOR})) \quad (eq. 1)$$

- V_{OUT} : Output Voltage (Volts)
- I_{OUT} : Max Output Current
- $R_{DS(ON)}$ = P-Channel Switch $R_{DS(ON)}$
- $R_{INDUCTOR}$: Inductor Resistance (DCR)

Undervoltage Lockout

The input voltage V_{IN} must reach 2.4 V (typ) before the NCV8925 enables the DC/DC converter output to begin the start up sequence (see Soft-Start section). The UVLO threshold hysteresis is typically 100 mV.

Shutdown Mode

Forcing this pin to a voltage below 0.4 V will shut down the IC. In shutdown mode, the internal reference, oscillator and most of the control circuitries are turned off. Therefore, the typical current consumption will be 0.3 μ A (typical value). Applying a voltage above 1.2 V to EN pin will enable the device for normal operation. The typical threshold is around 0.7 V. The device will go through soft-start to normal operation.

Thermal Shutdown

Internal Thermal Shutdown circuitry is provided to protect the integrated circuit in the event that the maximum junction temperature is exceeded. If the junction temperature exceeds 160°C, the device shuts down. In this mode switch Q1 and Q2 and the control circuits are all turned off. The device restarts in soft-start after the temperature drops below 135°C. This feature is provided to prevent catastrophic failures from accidental device overheating, and it is not intended as a substitute for proper heatsinking.

Short Circuit Protection

When the output is shorted to ground, the device limits the inductor current. The duty-cycle is minimum and the consumption on the input line is 300 mA (Typ). When the short circuit condition is removed, the device returns to the normal mode of operation.

APPLICATION INFORMATION

Output Voltage Selection

The output voltage is programmed through an external resistor divider connected from V_{OUT} to FB then to GND. For low power consumption and noise immunity, the resistor from FB to GND (R2) should be in the [100 k-600 k] range. If R2 is 200 k given the V_{FB} is 0.6 V, the current through the divider will be 3.0 μA.

The formula below gives the value of V_{OUT}, given the desired R1 and the R1 value:

$$V_{OUT} = V_{FB} \times \left(1 + \frac{R1}{R2}\right) \quad (\text{eq. 2})$$

- V_{OUT}: Output Voltage (Volts)
- V_{FB}: Feedback Voltage = 0.6 V
- R1: Feedback Resistor from V_{OUT} to FB
- R2: Feedback Resistor from FB to GND

Input Capacitor Selection

In PWM operating mode, the input current is pulsating with a large switching noise. Using an input bypass capacitor can reduce the peak current transients drawn from the input supply source, thereby reducing switching noise significantly. The capacitance needed for the input bypass capacitor depends on the source impedance of the input supply.

The maximum RMS current occurs at 50% duty cycle with maximum output current, which is I_{out_max}/2.

For NCV8925, a low profile ceramic capacitor of 4.7 μF should be used for most of the cases. For effective bypass results, the input capacitor should be placed as close as possible to the V_{IN} pin.

Table 1. LIST OF INPUT AUTOMOTIVE CAPACITORS

| | | |
|--------|-----------------|--------|
| Murata | GCM31CR71C475 | 4.7 μF |
| TDK | C3216X7R1E475MT | 4.7 μF |

Output L-C Filter Design Considerations

The NCV8925 operates at 3 MHz frequency and uses voltage mode architecture. The correct selection of the output filter ensures good stability and fast transient response.

Due to the nature of the buck converter, the output L-C filter must be selected to work with internal compensation. For NCV8925, the internal compensation is internally fixed and it is optimized for an output filter of L = 2.2 μH and C_{OUT} = 4.7 μF.

The corner frequency is given by:

$$f_c = \frac{1}{2\pi\sqrt{L \times C_{OUT}}} = \frac{1}{2\pi\sqrt{2.2 \mu\text{H} \times 4.7 \mu\text{F}}} = 49 \text{ kHz} \quad (\text{eq. 3})$$

The device is intended to operate with inductance value of 2.2 μH.

If the corner frequency is moved, it is recommended to check the loop stability depending on the accepted output ripple voltage and the required output current. Take care to check the loop stability. The phase margin is usually higher than 45°.

Table 2. L-C Filter Example

| Inductance (L) | Output Capacitor (C _{OUT}) |
|----------------|--------------------------------------|
| 1.0 μH | 10 μF |
| 2.2 μH | 4.7 μF |

Inductor Selection

The inductor parameters directly related to device performances are saturation current and DC resistance and inductance value. The inductor ripple current (ΔI_L) decreases with higher inductance:

$$\Delta I_L = \frac{V_{OUT}}{L \times f_{SW}} \left(1 - \frac{V_{OUT}}{V_{IN}}\right) \quad (\text{eq. 4})$$

- ΔI_L: Peak to Peak Inductor Ripple Current
- L: Inductor Value
- f_{SW}: Switching Frequency

The saturation current of the inductor should be rated higher than the maximum load current plus half the ripple current:

$$I_{L(MAX)} = I_{O(MAX)} + \frac{\Delta I_L}{2} \quad (\text{eq. 5})$$

- ΔI_{L(MAX)}: Maximum Inductor Current
- ΔI_{O(MAX)}: Maximum Output Current

The inductor's resistance will factor into the overall efficiency of the converter. For best performance, the DC resistance should be less than 0.3 Ω for good efficiency.

Table 3. LIST OF AUTOMOTIVE INDUCTORS

| | | | |
|-----------|-----------------|--------|--------|
| Coilcraft | DO3316T-102ML | 1.0 μH | 11 A |
| | DO3316T-222ML | 2.2 μH | 7.8 A |
| TDK | NLCV32T-1R0M-PF | 1.0 μH | 1.0 A |
| | NLCV32T-2R2M-PF | 2.2 μH | 0.77 A |

Output Capacitor Selection

Selecting the proper output capacitor is based on the desired output ripple voltage. Ceramic capacitors with low ESR values will have the lowest output ripple voltage and are strongly recommended. The output capacitor requires an X7R dielectric.

The output ripple voltage in PWM mode is given by:

$$\Delta V_{OUT} = \Delta I_L \times \left(\frac{1}{4 \times f_{SW} \times C_{OUT}} + ESR \right) \quad (\text{eq. 6})$$

- ΔV_{OUT} : Output Voltage Ripple in PWM Mode
- ΔI_L : Peak to Peak Inductor Ripple Current
- f_{SW} : Switching Frequency
- C_{OUT} : Output Capacitor
- ESR: Output Capacitor Serial Resistor

Table 4. LIST OF OUTPUT CAPACITORS

| | | |
|--------|-----------------|-------------|
| Murata | GCM31CR71C475 | 4.7 μ F |
| | GCM31CR71A106 | 10 μ F |
| TDK | C3216X7R1E475MT | 4.7 μ F |
| | C3216X7R1C106MT | 10 μ F |

Feed-Forward Capacitor Selection

The feed-forward capacitor sets the feedback loop response and is critical to obtain good loop stability.

Given that the compensation is internally fixed, an 18 pF or higher ceramic capacitor is needed. Choose a small ceramic capacitor X7R dielectric.

NCV8925

PACKAGE DIMENSIONS

TSOP-5 CASE 483-02 ISSUE H

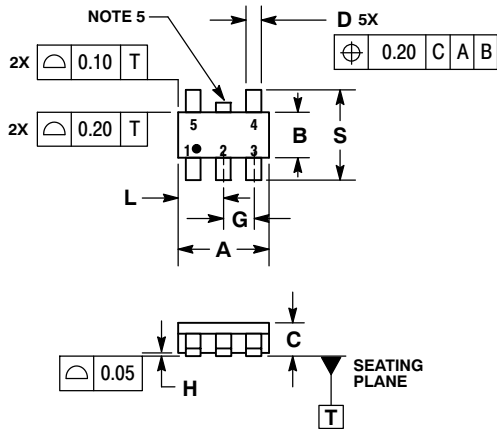

NOTES:

1. DIMENSIONING AND TOLERANCING PER ASME Y14.5M, 1994.
2. CONTROLLING DIMENSION: MILLIMETERS.
3. MAXIMUM LEAD THICKNESS INCLUDES LEAD FINISH THICKNESS. MINIMUM LEAD THICKNESS IS THE MINIMUM THICKNESS OF BASE MATERIAL.
4. DIMENSIONS A AND B DO NOT INCLUDE MOLD FLASH, PROTRUSIONS, OR GATE BURRS.
5. OPTIONAL CONSTRUCTION: AN ADDITIONAL TRIMMED LEAD IS ALLOWED IN THIS LOCATION. TRIMMED LEAD NOT TO EXTEND MORE THAN 0.2 FROM BODY.

| DIM | MILLIMETERS | |
|-----|-------------|------|
| | MIN | MAX |
| A | 3.00 BSC | |
| B | 1.50 BSC | |
| C | 0.90 | 1.10 |
| D | 0.25 | 0.50 |
| G | 0.95 BSC | |
| H | 0.01 | 0.10 |
| J | 0.10 | 0.26 |
| K | 0.20 | 0.60 |
| L | 1.25 | 1.55 |
| M | 0° | 10° |
| S | 2.50 | 3.00 |

SOLDERING FOOTPRINT*

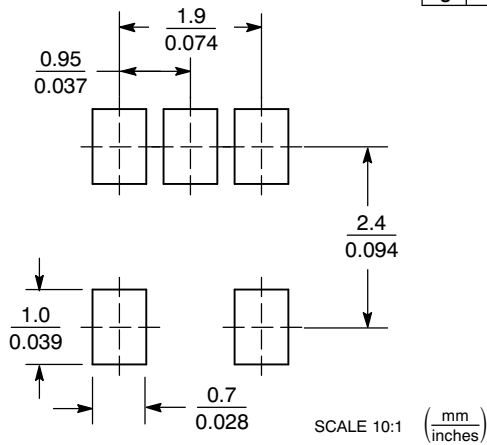

*For additional information on our Pb-Free strategy and soldering details, please download the ON Semiconductor Soldering and Mounting Techniques Reference Manual, SOLDERRM/D.

NCV8925

PACKAGE DIMENSIONS

UDFN6 2x2, 0.65P
CASE 517AB-01
ISSUE B

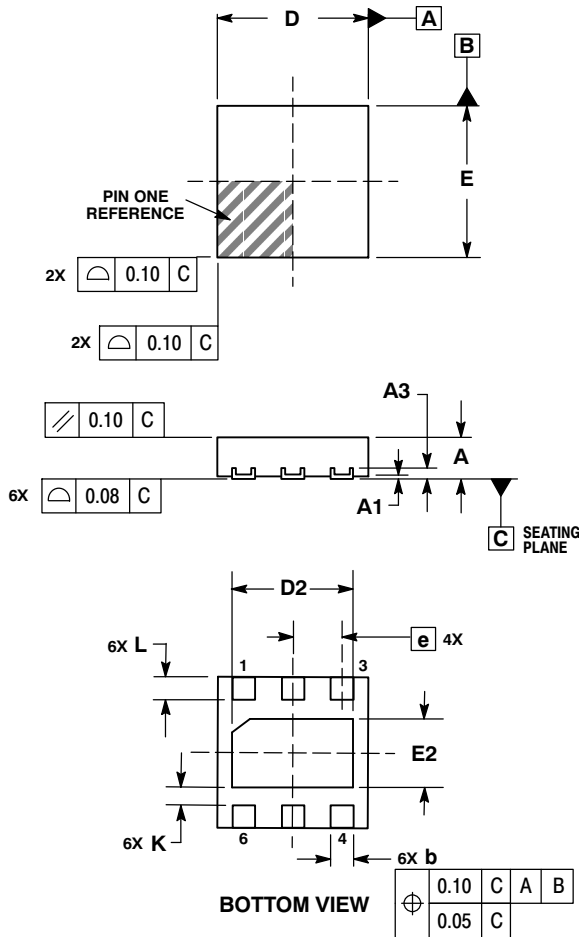

NOTES:

1. DIMENSIONING AND TOLERANCING PER ASME Y14.5M, 1994.
2. CONTROLLING DIMENSION: MILLIMETERS.
3. COPLANARITY APPLIES TO THE EXPOSED PAD AS WELL AS THE TERMINALS.

| DIM | MILLIMETERS | |
|-----|-------------|------|
| | MIN | MAX |
| A | 0.45 | 0.55 |
| A1 | 0.00 | 0.05 |
| A3 | 0.127 REF | |
| b | 0.25 | 0.35 |
| D | 2.00 BSC | |
| D2 | 1.50 | 1.70 |
| E | 2.00 BSC | |
| E2 | 0.80 | 1.00 |
| e | 0.65 BSC | |
| K | 0.20 | --- |
| L | 0.25 | 0.35 |

SOLDERING FOOTPRINT*

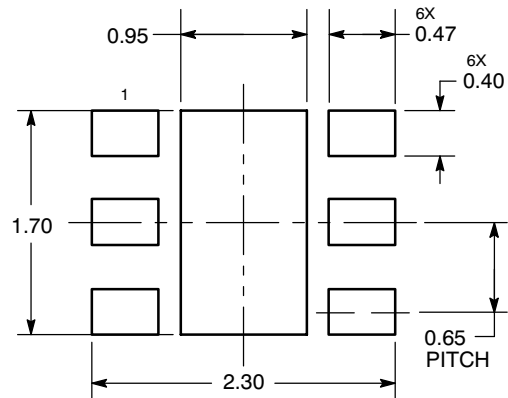

DIMENSIONS: MILLIMETERS

*For additional information on our Pb-Free strategy and soldering details, please download the ON Semiconductor Soldering and Mounting Techniques Reference Manual, SOLDERRM/D.

The products described herein (NCV8925), may be covered by one or more of the following U.S. patent(s); **TBD**. There may be other patents pending.

ON Semiconductor and **ON** are registered trademarks of Semiconductor Components Industries, LLC (SCILLC). SCILLC reserves the right to make changes without further notice to any products herein. SCILLC makes no warranty, representation or guarantee regarding the suitability of its products for any particular purpose, nor does SCILLC assume any liability arising out of the application or use of any product or circuit, and specifically disclaims any and all liability, including without limitation special, consequential or incidental damages. "Typical" parameters which may be provided in SCILLC data sheets and/or specifications can and do vary in different applications and actual performance may vary over time. All operating parameters, including "Typicals" must be validated for each customer application by customer's technical experts. SCILLC does not convey any license under its patent rights nor the rights of others. SCILLC products are not designed, intended, or authorized for use as components in systems intended for surgical implant into the body, or other applications intended to support or sustain life, or for any other application in which the failure of the SCILLC product could create a situation where personal injury or death may occur. Should Buyer purchase or use SCILLC products for any such unintended or unauthorized application, Buyer shall indemnify and hold SCILLC and its officers, employees, subsidiaries, affiliates, and distributors harmless against all claims, costs, damages, and expenses, and reasonable attorney fees arising out of, directly or indirectly, any claim of personal injury or death associated with such unintended or unauthorized use, even if such claim alleges that SCILLC was negligent regarding the design or manufacture of the part. SCILLC is an Equal Opportunity/Affirmative Action Employer. This literature is subject to all applicable copyright laws and is not for resale in any manner.

PUBLICATION ORDERING INFORMATION

LITERATURE FULFILLMENT:
Literature Distribution Center for ON Semiconductor
P.O. Box 5163, Denver, Colorado 80217 USA
Phone: 303-675-2175 or 800-344-3860 Toll Free USA/Canada
Fax: 303-675-2176 or 800-344-3867 Toll Free USA/Canada
Email: orderlit@onsemi.com

N. American Technical Support: 800-282-9855 Toll Free USA/Canada
Europe, Middle East and Africa Technical Support:
Phone: 421 33 790 2910
Japan Customer Focus Center
Phone: 81-3-5773-3850

ON Semiconductor Website: www.onsemi.com
Order Literature: <http://www.onsemi.com/orderlit>

For additional information, please contact your local Sales Representative