

LEFT SIDE VIEW

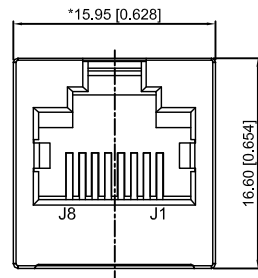

FRONT VIEW

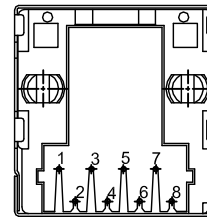

BACK VIEW

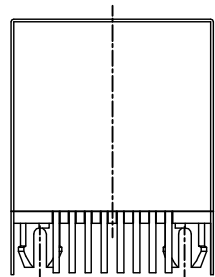
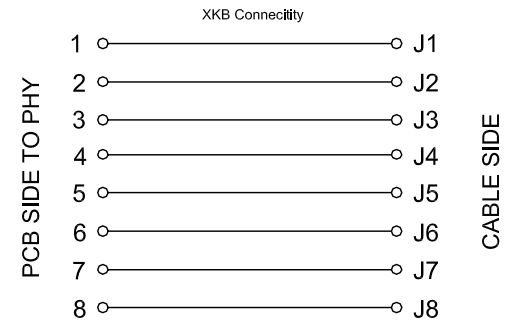

BOTTOM VIEW

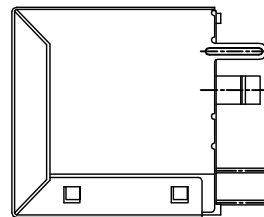

RIGHT SIDE VIEW

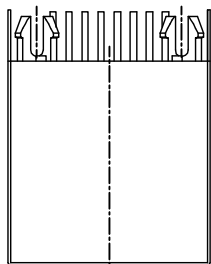

TOP VIEW

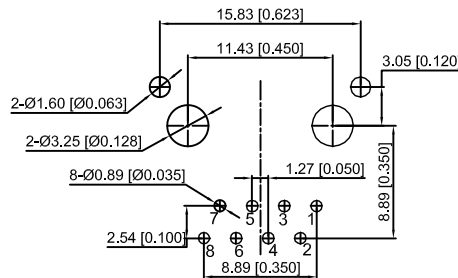

RECOMMENDED PCB LAYOUT  
VIEWED FROM COMPONENT SIDE

XKB Connectivity

XKB Connectivity

**MATERIAL 材料:**

HOUSING 外壳: PBT,UL94V-0,BLACK.

TERMINAL 端子: PHOSPHOR BRONZE ,Ø=0.46MM,  
GOLD PLATING ON CONTACT AREA.

SHIELD 保护物:C2680,T=0.20MM,20 MIN NICKEL PLATING  
ON ALL AREA.

**MECHANICAL 机械:**

DURABILITY 耐用性: 750 CYCLES MIN.12.5MM/MINUTE

INSERTION FORCE 插入力: 2.2KG.F MAX

RETENTION STRENGTH 固位力:7.7KG.F BETWEEN JACK AND PLUG

OPERATING TEMPERATURE 工作温度: -40°C~+85°C.

STORAGE TEMPERATURE 储存温度: -40°C~+85°C.

ALL CRITICAL DIMENSIONS WITH "\*"

**ELECTRICAL 电动:**

VOLTAGE 电压:125 VOL TS AC

CURRENT RATING 额定电流:1.5AMP

DIELECTRIC STRENGTH 介电强度:1000 VAC RMS 50HZ OR 60HZ,1MIN

INSULATION RESISTANCE 绝缘电阻:500 MEGA OHMS MIN.INITIAL  
AFTER 500V DC FOR 1 MINUTE

CONTACT RESISTANCE 接触电阻:SINGLE TERMINAL 30 MILLIOHMS MAX  
INITIAL 50 MILLIOHMS MAX.AFTER  
DURABILITY TEST

|  |  |  |  |  |   |  |      |  |                                      |                        |          |
|--|--|--|--|--|---|--|------|--|--------------------------------------|------------------------|----------|
|  |  |  |  |  | DSND  |  | DATE |  | SCALE: N/A                           | MODEL TYPE:<br>RJ JACK |          |
|  |  |  |  |  | DWN   |  | DATE |  | VIEW:                                | PART NO.:              |          |
|  |  |  |  |  | CHKD  |  | DATE |  | UNIT: mm/in                          | DWG NO.:               |          |
|  |  |  |  |  | APPD  |  | DATE |  | SIZE: A4                             | X05ADGWA3DY1027        |          |
|  |  |  |  |  | UNSPECIFIED TOLERANCES                        |  |      |  | XKB INDUSTRIAL PRECISION CO.,LIMITED |                        |          |
|  |  |  |  |  |   |  |      |  | WEIGHT                               | SHEET                  | REVISION |
|  |  |  |  |  |   |  |      |  | 1.0g                                 | 1/1                    | A0       |
|  |  |  |  |  | www.xk-dg.cn www.helloxkb.com www.helloxkb.cn |  |      |  |                                      |                        |          |