

NORA-W40 series

Stand-alone multiradio modules

Data sheet



Abstract

Targeted towards system integrators and design engineers, this technical data sheet includes the functional description, pin definition, specifications, country approval status, handling instructions, and ordering information for NORA-W40 series modules.

Supporting Wi-Fi 6 (802.11b/g/n/ax), Bluetooth Low Energy v5.3, Zigbee 3.0 and Thread 1.3 (802.15.4). NORA-W40 standalone, multiradio modules offer a host-less, open CPU configuration that allows customer applications to run on the module itself – with no need for a supporting host MCU. NORA-W40 series modules are ideal for Internet of Things (IoT) devices, telematics, low-power sensors, connected buildings (appliances and surveillance), point-of-sales, health devices, AI, facial recognition, and other design solutions that demand top-grade security.

Document information

Title	NORA-W40 series	
Subtitle	Stand-alone multiradio modules	
Document type	Data sheet	
Document number	UBXDOC-465451970-3088	
Revision and date	R02	16-Sep-2024
Disclosure restriction	C1-Public	

Product status	Corresponding content status	
Functional sample	Draft	For functional testing. Revised and supplementary data will be published later.
In development / Prototype	Objective Specification	Target values. Revised and supplementary data will be published later.
Engineering sample	Advance Information	Data based on early testing. Revised and supplementary data will be published later.
Initial production	Early Production Information	Data from product verification. Revised and supplementary data may be published later.
Mass production / End of life	Production Information	Document contains the final product specification.

This document applies to the following products:

Product name	Type number	Hardware version	PCN reference	Product status
NORA-W401	NORA-W401-00B-00	04	N/A	Engineering sample
NORA-W406	NORA-W406-00B-00	04	N/A	Engineering sample
NORA-W401	NORA-W401-10B-00	14	N/A	In development
NORA-W406	NORA-W406-10B-00	14	N/A	In development

u-blox or third parties may hold intellectual property rights in the products, names, logos, and designs included in this document. Copying, reproduction, or modification of this document or any part thereof is only permitted with the express written permission of u-blox. Disclosure to third parties is permitted for clearly public documents only.

The information contained herein is provided "as is" and u-blox assumes no liability for its use. No warranty, either express or implied, is given, including but not limited to, with respect to the accuracy, correctness, reliability, and fitness for a particular purpose of the information. This document may be revised by u-blox at any time without notice. For the most recent documents, visit www.u-blox.com.

Copyright © u-blox AG.

Contents

Document information	2
Contents	3
1 Functional description	5
1.1 Overview.....	5
1.2 Applications	5
1.3 Block diagram	6
1.4 Product variants.....	6
1.4.1 NORA-W401	6
1.4.2 NORA-W406	6
1.5 Radio performance	7
1.6 CPU.....	7
1.6.1 Software upgrade	8
1.7 MAC addresses	8
1.8 Power modes.....	8
2 Interfaces	9
2.1 Power supply	9
2.1.1 Module supply input (VCC)	9
2.1.2 Digital I/O interfaces reference voltage (VCC_IO).....	9
2.2 Low frequency clock	9
2.3 Module reset	9
2.4 Boot strap pins	10
2.5 RF antenna interface.....	10
2.5.1 Internal antenna.....	10
2.5.2 External RF antenna interface.....	11
2.6 IO signals.....	11
2.7 Pulse Width Modulation (PWM)	11
2.8 Data interfaces.....	12
2.8.1 UARTs	12
2.8.2 SPI	12
2.8.3 Dual/Quad SPI.....	12
2.8.4 I2C	12
2.8.5 I2S	13
2.8.6 SDIO.....	13
2.8.7 Pulse Count Controller.....	13
2.8.8 TWAI.....	13
2.9 Debug interfaces.....	13
2.9.1 JTAG debug interfaces	13
2.10 Analog interfaces	13
2.10.1 Analog to digital converters	13
2.11 USB Serial/JTAG Controller	13

3	Pin definition	14
3.1	Input and output pins	14
3.2	NORA-W40 pin assignment	14
3.3	Pin-out	15
4	Electrical specifications	18
4.1	Absolute maximum ratings	18
4.1.1	Maximum ESD ratings	18
4.2	Operating conditions	18
4.2.1	Operating temperature range	18
4.2.2	Supply/Power pins	19
4.2.3	RESET_N pin	19
4.2.4	LPO clock	20
4.2.5	Digital pins	20
4.2.6	Current consumption	21
4.2.7	Wi-Fi characteristics and absolute maximum radio performance	21
4.2.8	Bluetooth Low Energy characteristics and absolute maximum radio performance	22
4.2.9	Antenna radiation patterns	23
5	Mechanical specifications	26
5.1	NORA-W401/W406 mechanical specifications	26
6	Qualification and approvals	28
6.1	Country approvals	28
6.2	Bluetooth qualification information	28
7	Product handling	29
7.1	Packaging	29
7.1.1	Reels	29
7.1.2	Tapes	29
7.2	Moisture sensitivity levels	30
7.3	Reflow soldering	30
7.4	ESD precautions	30
8	Labeling and ordering information	31
8.1	Product labeling	31
8.2	Product identifiers	32
8.3	Identification codes	32
8.4	Ordering information	32
	Appendix	33
A	Glossary	33
	Related documents	34
	Revision history	34
	Contact	34

1 Functional description

1.1 Overview

The NORA-W40 series comprises small, stand-alone, multiradio modules that integrate a powerful microcontroller (MCU) and a radio for wireless communication. The open CPU architecture allows customers to develop advanced applications running on the single core high power 32-bit RISC-V MCU and a low power supplement 32-bit RISC-V MCU. The radio provides support for Wi-Fi 802.11b/g/n/ax in the 2.4 GHz ISM band, Bluetooth v5.3 (Bluetooth Low Energy communications), Zigbee 3.0 and Thread 1.3 (802.15.4). They all coexist and share the same antenna.

These compact modules include the wireless MCU, flash memory, crystal, and other components for matching, filtering, antenna, decoupling, and antenna operation. Supporting integrated cryptographic hardware accelerators, NORA-W40 series modules are ideal for Internet of Things (IoT) devices, telematics, low power sensors, connected factories, connected buildings (appliances and surveillance), point-of-sales, health devices, artificial intelligence, facial recognition, and other design solutions that demand top-grade security.

NORA-W40 is based on the Espressif ESP32-C6 chip [3]. It is the third generation of u-blox modules residing on the Espressif ESP32 series WiFi and Bluetooth chip. First generation, NINA-W1/B2 series modules are based on the Espressif ESP32 chip [4] and second generation, NORA-W1/W2 series modules are based on Espressif ESP32-S3 chip [5]. The simple device design allows developers to use an external antenna (NORA-W401) or utilize the internal antenna (NORA-W406) in the application design.

The mechanical design of NORA-W40 is based on the NORA form factor.

NORA-W40 modules will be compliant with the Radio Equipment Directive (RED) and will also be certified in the following countries: Great Britain (UKCA), US (FCC), Canada (IC / ISED RSS), Japan (MIC), Taiwan (NCC), South Korea (KCC) and Australia / New Zealand (ACMA). The modules are also qualified according to u-blox qualification policy, based on AEC-Q104 standard for professional grade operation. NORA-W40 supports temperature range of $-40\text{ }^{\circ}\text{C}$ to $+85$, see [Operating temperature range](#).

1.2 Applications

NORA-W40 series are suitable for a wide range of applications, including:

- Wi-Fi networks
- Internet of Things (IoT)
- Bluetooth low energy applications
- Telematics
- Point-of-sales
- Medical and industrial networks
- Access to laptops, mobile phones, and similar consumer devices
- Home/building automation apps
- Wireless gateways
- Artificial intelligence (AI)
- Facial recognition

1.3 Block diagram

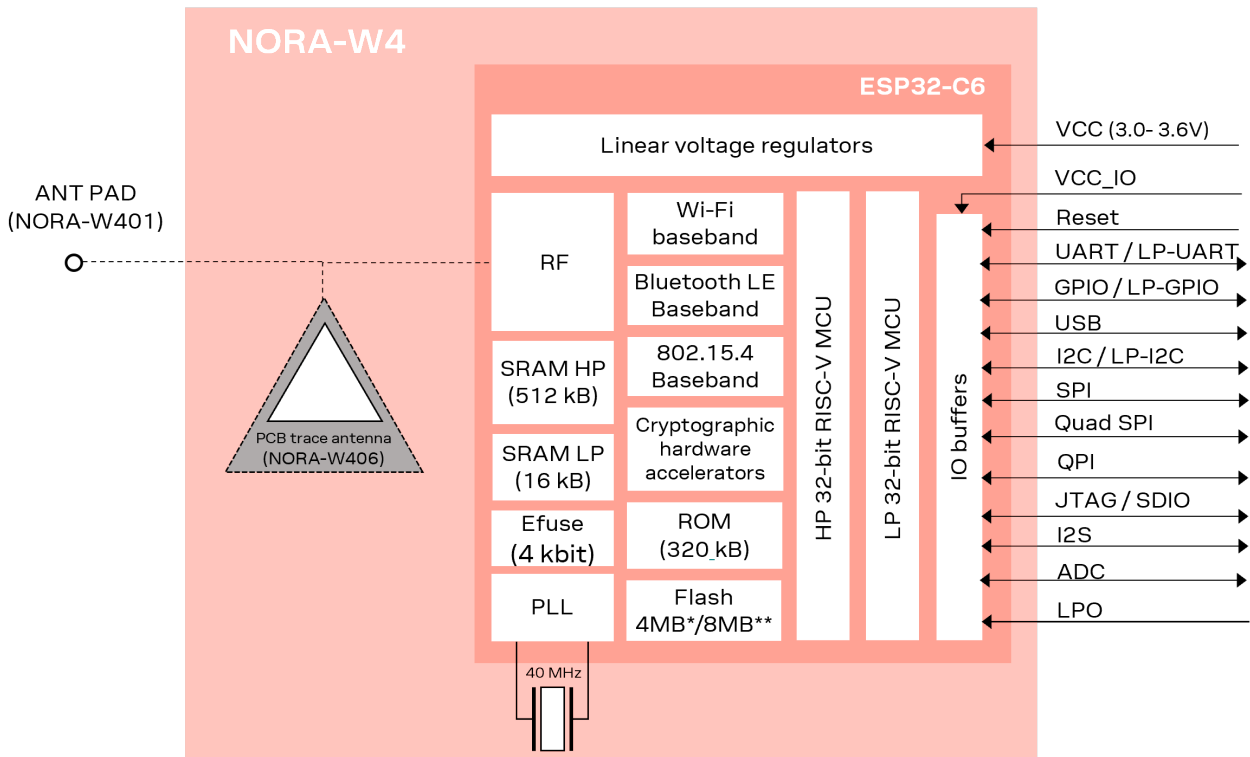

* Only on NORA-W401-00B and NORA-W406-00B

** Only on NORA-W401-10B and NORA-W406-10B

Figure 1: NORA-W40 series block diagram

1.4 Product variants

NORA-W40 modules have an open CPU architecture that is tailored towards OEMs that want to embed Wi-Fi and Bluetooth LE support into their own application.

1.4.1 NORA-W401

NORA-W401-00B has no internal antenna, but the RF signal for routing to an external antenna or antenna connector signal is available through a dedicated module pin instead. See also the list of approved antennas in the NORA-W40 system integration manual [1]. The 00B version includes an embedded flash of 4 MB and the 10B version includes an embedded flash of 8 MB.

NORA-W401 has an outline of 10.4 (length) x 14.3 mm (width) x 1.9 mm (height).

1.4.2 NORA-W406

NORA-W406-00B is equipped with an internal PCB trace antenna, using antenna technology licensed from Abracon. The RF signal is not connected to any module pin. The 00B version includes an embedded flash of 4 MB with quad SPI and the 10B version includes an embedded flash of 8 MB.

NORA-W406 has an outline of 10.4 (length) x 14.3 mm (width) x 1.9 mm (height).

1.5 Radio performance

NORA-W40 series (NORA-W401, and NORA-W406) modules support Wi-Fi and are conformant with IEEE 802.11b/g/n/ax single-band 2.4 GHz operation and Bluetooth LE specifications, as shown in [Table 1](#).

Wi-Fi	Bluetooth Low Energy
IEEE 802.11b/g/n/ax	Bluetooth 5.3 Bluetooth LE
Band support Station mode: 2.4 GHz, channel 1-14* Access Point mode: 2.4 GHz, channel 1-14*	Band support 2.4 GHz, 40 channels
Typical conducted output power : 17 dBm	Typical conducted output power 7 dBm
Typical radiated output power: 20 dBm EIRP**	Typical radiated output power 10 dBm EIRP**
Conducted sensitivity -99 dBm	Conducted sensitivity -98 dBm
Data rates: IEEE 802.11b: 1 / 2 / 5.5 / 11 Mbit/s IEEE 802.11g: 6 / 9 / 12 / 18 / 24 / 36 / 48 / 54 Mbit/s IEEE 802.11n: MCS 0-7, HT20 (72 Mbit/s, Max), HT40 (150 Mbit/s, Max) IEEE 802.11ax MCS 0-9, HE20 (114 Mbit/s, Max)	Data rates: 1 / 2 Mbit/s 125 / 500 Kbit/s

* Depending on the location (country or region), channels 12-14 must be limited or disabled. Consequently, the software implementation must support country determination algorithms when using channels 12-14. For example, algorithms must be supported on these channels to comply with 802.11d amendment standard. For further information, see the NORA-W40 series system integration manual [\[1\]](#).

** RF power including maximum antenna gain (3 dBi)

Table 1: NORA-W40 series Wi-Fi and Bluetooth characteristics

1.6 CPU

NORA-W40 series modules have a single-core system with a 32-bit HP RISC -V processor operating at a maximum 160 MHz internal clock frequency. Additionally, a low power LP 32-bit RISC-V processor resides in the NORA-W40 operating at maximum frequency of 20MHz. The LP replaces the HP processor during sleep modes or as a supplement in active mode to save power.

The main features of the internal NORA-W40 memories include:

- 320 kByte ROM for booting and core functions.
- HP memory: 512 kByte SRAM for data and instruction.
- LP memory: 16 kB of SRAM that can be accessed by HP CPU or LP CPU. It can retain data in Deep-sleep mode.
- 4/8 MByte FLASH (-00B/-10B) for code storage, including hardware encryption to protect programs.
- 4 kbit EFUSE (non-erasable memory) for MAC addresses, module configuration, flash encryption, and chip ID.

NORA-W40 has no software but includes an Open CPU architecture that allows customers to develop advanced applications running on the dual core 32-bit MCU. The radio provides support for Wi-Fi 802.11b/g/n/ax in the 2.4 GHz ISM band, and Bluetooth LE communication.

NORA-W40 Open CPU also support external PSRAM memory depending upon the module variant.

The customer is responsible for the NORA-W40 certification and configuration, as described in [Country approvals](#).

NORA-W40 series modules can be used to design solutions with top-grade security. Including integrated cryptographic hardware accelerators, the modules feature secure boot functionality that ensures that the module can only be restarted with authenticated software.

1.6.1 Software upgrade

For information about upgrading NORA-W40 series software, see the NORA-W40 system integration manual [\[1\]](#).

1.7 MAC addresses

For information about MAC addresses, see https://docs.espressif.com/projects/espressif/en/v5.2/esp32c6/api-reference/system/misc_system_api.html#mac-address

1.8 Power modes

NORA-W40 series modules are power efficient devices capable of operating in different power saving modes and configurations. Different sections of the module can be powered off when they are not needed, and complex wake up events can be generated from different external and internal inputs.

For the lowest power consumption modes an external LPO clock or low frequency crystal is required. See also [Low frequency clock](#).

For more information about power modes, see the Espressif ESP32-C6 Datasheet [\[3\]](#) and the Espressif API Reference guide [\[1\]](#) section about sleep modes.

2 Interfaces

2.1 Power supply

The power for NORA-W40 series modules is supplied through **VCC** and **VCC_IO** pins by DC voltage.

-  The system power supply circuit must be able to provide enough current to support the highest Wi-Fi output power. This must be considered during dimensioning the power supply circuitry.

2.1.1 Module supply input (VCC)

NORA-W40 series modules use an integrated Linear Voltage converter to transform and stabilize the supply voltage applied to the **VCC** pin.

2.1.2 Digital I/O interfaces reference voltage (VCC_IO)

All NORA-W40 series modules have an additional supply input for setting the I/O voltage level. Currently, NORA-W40 modules support a 3.3 V IO voltage level.

2.2 Low frequency clock

NORA-W40 series modules do not have an internal low power oscillator (LPO) or low frequency crystal (LFXTAL), which is required for low power modes. If low power modes are required, a 32.768 kHz clock signal can be supplied externally.

2.3 Module reset

NORA-W40 series modules can be reset (rebooted) with a low-level input on the **RESET_N** pin. The logic level of this pin is normally set high using an internal pull-up resistor. The low-level input triggers a “hardware reset” of the module. The **RESET_N** signal should be driven by an open drain, open collector, or contact switch.

2.4 Boot strap pins

Several module pins related to the boot configuration must be strapped correctly using either pull-up or pull-down resistors, as shown in [Table 2](#).

⚠ Boot strap pins should be avoided if other GPIO pins can be used instead. Note that all module pins configured to their default state internally in the ESP32-C6 chip (shown in bold) must NOT be configured externally.

Pin	ESP32-C6 GPIO	State during boot	Default	Behavior	Description
J8, F7	GPIO8, GPIO9*	00		Invalid, do not use	
		01		Normal Boot from internal Flash	SPI Boot
		10		Download Boot	Bootling Mode
		11	Default	Normal Boot from internal Flash	SPI Boot
H9	GPIO15	0	N/A	<i>EFUSE_DIS_USB_JTAG = 0,</i> <i>EFUSE_DIS_PAD_JTAG = 0,</i> <i>EFUSE_JTAG_SEL_ENABLE = 1</i> JTAG signal from on-chip JTAG pins	JTAG Signal Selection
		1		<i>EFUSE_DIS_USB_JTAG = 0,</i> <i>EFUSE_DIS_PAD_JTAG = 0,</i> <i>EFUSE_JTAG_SEL_ENABLE = 1</i> JTAG signal from USB Serial/JTAG controller	
		D/C		<i>EFUSE_DIS_USB_JTAG = 0,</i> <i>EFUSE_DIS_PAD_JTAG = 0,</i> <i>EFUSE_JTAG_SEL_ENABLE = 0</i> JTAG signal from USB Serial/JTAG controller	

*Pull-up internally 45 kΩ

Table 2: NORA-W40 series boot strapping pins

2.5 RF antenna interface

NORA-W40 modules' single antenna interface supports Wi-Fi, Bluetooth LE, Zigbee and Thread. The different communication protocols are time divided on the antenna and are switched between the Zigbee, Thread, Bluetooth, and Wi-Fi data. Although the communication using these different protocols is (more or less) transparent in the application, these protocols are never active at exactly the same time as they are in the module antenna.

NORA-W40 series modules support either a single internal antenna (NORA-W406) or external antennas connected through a dedicated antenna pin (NORA-W401). For an overview of the different antenna types (internal, integrated, and external) described in this section, see also the system integration manual [\[1\]](#).

2.5.1 Internal antenna

NORA-W406 modules have internal antennas that are specifically designed and optimized for NORA modules. NORA-W401 modules do not support an internal antenna.

NORA-W406 is equipped with a 2.4 GHz PCB trace antenna that is ideally placed in the middle of the module – along the side edge of the host PCB. For further information about antenna placement, see the system integration manual [\[1\]](#).

In NORA-W406 designs, keep a minimum clearance of 5 mm between the antenna and the casing. If a metal enclosure is required, use NORA-W401 and an external antenna.

It is beneficial to have a large solid ground plane on the host PCB with a proper grounding on the module. A 50 x 50 mm ground plane is recommended but its size should be no less than 24x30 mm.

For more information about antenna-related design, see also the NORA-W40 series system integration manual [1].

 The **ANT** solder pin (K9) on NORA-W406 modules is internally unconnected and consequently not available for fitting any external antenna.

2.5.2 External RF antenna interface

NORA-W401 has an antenna signal (**ANT**) pin with a characteristic impedance of 50 Ω for using an external antenna. The antenna signal supports both Tx and Rx.

An SMD antenna, or any other antenna featured in the pre-approved antennas list residing in the NORA-W40 system integration manual [1], can be employed as an external antenna or an integrated antenna on the host PCB. An antenna connector, for use with an external antenna through a coaxial cable, could also be implemented in the application design. A cable antenna might be necessary if the module is mounted in a shielded enclosure such as a metal box or cabinet.

An external antenna connector (U.FL. connector) features in the NORA-W40 reference design shown in the NORA-W40 series system integration manual [1]). The reference design must be followed to comply with regulatory approvals.

See also the list of pre-approved antennas in the NORA-W40 system integration manual [1].

2.6 IO signals

The NORA-W40 form factor includes a total of 82 pins, of which 22 pins are configurable as both input and output. These pins can function as GPIO signals and can also be multiplexed with digital and analog interfaces.

To maintain compatibility with the NORA form factor, certain signals are routed to multiple pins, as detailed in Table 4. For instance, GPIO9 is connected to both F7 (IO/BOOT) and H8 (IO/LED_GREEN).

It is also possible to multiplex all interfaces to any pin through an IO MUX, but the speed is limited. See also [Digital pins](#).

2.7 Pulse Width Modulation (PWM)

The Pulse Width Modulation (PWM) functionality can be used for different purposes, for example to control the intensity of LEDs and driving digital motors. The controller consists of PWM timers, the PWM operator, and a dedicated capture sub-module. Each timer provides timing in synchronous or independent form, and each PWM operator generates the waveform for one PWM channel.

The PWM controller has eight channels, which can generate independent waveforms that can be used to drive RGB LED devices. For maximum flexibility, the high-speed and low-speed channels can be driven from one of four timers. The PWM controller can also automatically increase or decrease the duty cycle gradually, which allows for fades without any processor interference. The PWM signals can be configured to be available on any of the GPIO pins via the IO MUX.

2.8 Data interfaces

2.8.1 UARTs

NORA-W40 modules have three UART interfaces, UART0, UART1 and LP UART. All UART interfaces can be routed to any GPIO pin through the IO MUX. UART0 serves as the primary interface port, where the firmware upgrades are performed. Consequently, the default pins of UART0 are recommended to not be routed to any other pins. For further information about the default pins, see also [Pin-out](#).

All UART interfaces provide hardware management of the CTS and RTS signals and software flow control (XON and XOFF).

2.8.1.1 UART0 and UART1

These interfaces provide asynchronous communication, for example RS232, RS485 and IrDA standards (with external drivers). The maximum speed for UART interfaces is 5 Mbit/s.

2.8.1.2 LP UART

LP UART only supports asynchronous communication (RS232) at a speed of up to 1.25 Mbit/s. LP UART can only be accessed by the CPU.

2.8.2 SPI

There are three SPI, SPI0/1/2, whereof two SPI are dedicated for internal embedded memories. They are not available for applications. The third SPI, SPI2, can be configured for general-purpose SPI and is available for external devices using a single SPI interface. It is also possible to configure the SPI interface as a dual or quad SPI (2 or 4-bit bidirectional data signals). See also [Dual/Quad SPI](#).

It is possible to connect the SPI interface to other pins via the IO MUX but the maximum speed is reduced.

2.8.3 Dual/Quad SPI

The dual/quad SPI (2 or 4 bi-bidirectional data signals) can be used for connecting an additional external PSRAM/Flash. The SPI to dual/quad SPI signal mappings is shown in [Table 3](#).

SPI signal	Dual SPI signal	Quad SPI signal
MOSI (Main Out / Sub In)	IO0	IO0
MISO (Main In / Sub Out)	IO1	IO1
WP	-	IO2
HD	-	IO3
CS	CS	CS
CLK	CLK	CLK

Table 3: SPI to dual/quad SPI signal mapping

2.8.4 I2C

NORA-W40 modules offers two I2C bus interfaces including an LP I2C.

NORA-W40 modules can operate as both the controller and target on the I2C bus, using both standard (100 kbit/s) and fast (400 kbit/s) transmission speeds. The LP I2C is only used in controller mode. The interface uses the **SCL** signal to clock instructions and data on the **SDA** signal.

2.8.5 I2S

An I2S interface can be routed over any GPIO pin.

NORA-W40 modules can operate with an 8-bit, 16-bit, 24-bit, or 32-bit resolution, central mode and peripheral mode I2S interface. NORA-W40 allows half duplex and full duplex communication mode, with the clock frequency of 10 kHz up-to 40 MHz.

2.8.6 SDIO

SDIO is multiplexed with the JTAG interface and the SPI2 interface. It is possible to connect the SDIO interfaces to other pins via the IO MUX but the speed is limited. See also [Digital pins](#). SDIO specification version 2.0, peripheral device is supported, which means a host controller can access the module. Example of features: A clock range of 0–50 MHz, 1-bit SDIO and 4-bit SDIO transfer modes. The module acting as an SDIO host device is not supported.

2.8.7 Pulse Count Controller

NORA-W40 modules support four independent counters that count 1–65535 up to a maximum frequency of 40 MHz. Any GPIOs can be used.

2.8.8 TWAI

NORA-W40 modules support the Two-Wire Automotive Interface (TWAI) communication protocol (ISO 11898-1, CAN specification 2.0) with inherent message priorities and arbitration. It provides multi-controller and multi-cast communication with error detection and signaling. The TWAI controller can operate with a 1 kbit/s to 1 Mbit/s bit rate along with a 64-byte FIFO receiver. Any GPIOs can be used.

2.9 Debug interfaces

2.9.1 JTAG debug interfaces

NORA-W40 modules support the JTAG debug interface (**JTAG_TMS**, **JTAG_CLK**, **JTAG_TDI** and **JTAG_TDO**). The JTAG interface is multiplexed with the SDIO and SPI2 interface.

2.10 Analog interfaces

2.10.1 Analog to digital converters

NORA-W40 modules support a 12-bit, SAR, Analog to Digital Converter (ADC). Any analog capable pin can be used for ADC applications. All appropriate analog pins are shown in the [Pin-out](#).

For lower power consumption, NORA-W401, NORA-W406 modules can measure voltages in sleep mode and threshold settings can be used to wake the CPU.

2.11 USB Serial/JTAG Controller

NORA-W40 modules support built-in USB CDC-ACM serial port solution for a seamless communication with the chip and provides an efficient method for JTAG debugging. It enables a serial port emulation that is compatible with most modern operating systems, enabling plug-and-play operation. Additionally, it allows the host to control chip reset and initiate download mode.

The interface is USB 2.0 full speed compliant and is capable of up to 12 Mbit/s transfer speed. Hence, JTAG adapter functionality facilitates fast communication with the CPU debugging core through a compact representation of JTAG instructions. The controller also supports the reprogramming of attached flash memory via the ROM startup code and includes an internal PHY.

3 Pin definition

3.1 Input and output pins

All NORA-W40 modules have 82 pins. 22 pins can be used for either General Purpose input or output (GPIO).

3.2 NORA-W40 pin assignment

Figure 2 shows the multiplexed pin-out for NORA-W401 and NORA-W406 Open CPU modules. These, and several additional interfaces not shown here, are described in the [Pin-out](#).

Although it is also possible to multiplex all interfaces through an IO MUX using any pin, the maximum speed is limited. See also [Digital pins](#).

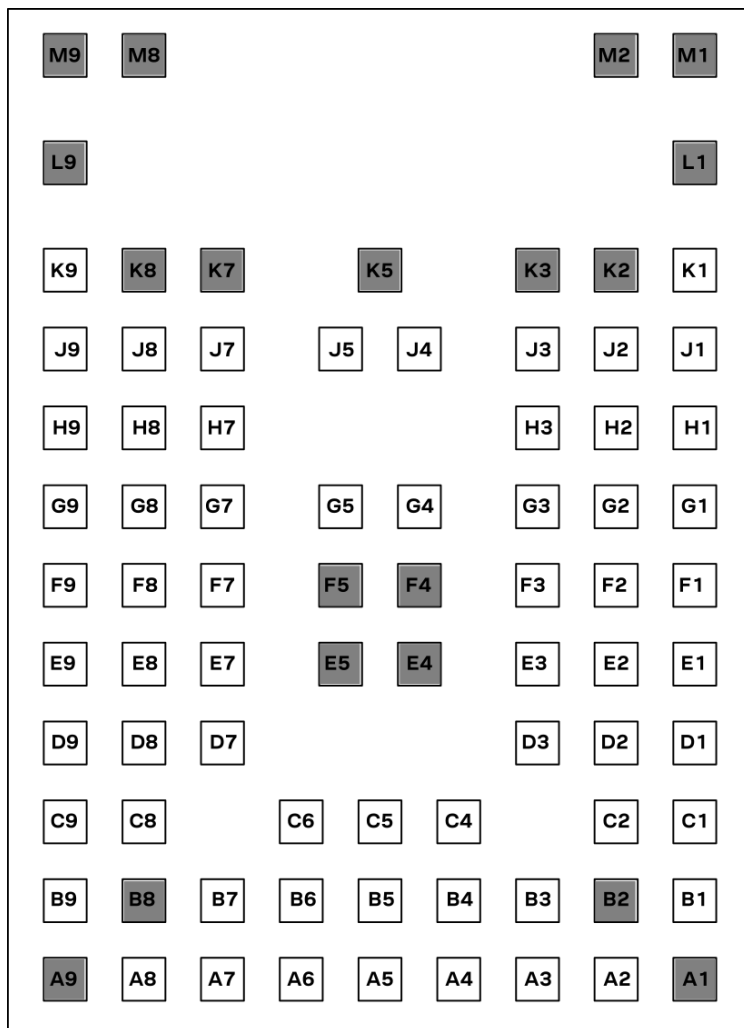





Figure 2: NORA-W401/W406 pin numbering (top view)

-  All grey pins located on the module are GND pins.
-  Pins A7, A8, B7, and J3 can only be used as input signals – regardless of the selected function/interface.
-  The signals for several pins are boot strapped. It is important that these signals, shown in the [Pin-out](#), are set in the correct state during startup. See also [Boot strap pins](#).

3.3 Pin-out

Table 4 describes the common pin-out for NORA-W401 and NORA-W406 series modules.

No.	NORA function	I/O ¹	Description	ESP32-C6 function	Remarks
A2	FSPIWP / GPIO21	I/O	SPI2 Write Protect / General Purpose I/O	FSPIWP / GPIO21	
A3	GPIO7/MTDO	I/O	General Purpose I/O	GPIO7	LP option (LP_GPIO7 / LP_I2C_SCL)
A4		NC			
A5	GPIO14	I/O		GPIO14	
A6		NC			
A7	VCCIO	I	Module I/O level voltage input		VIO voltage supply.
A8	VCC	I	Module supply voltage input		3.0-3.6 V module voltage supply.
B1	FSPICLK / GPIO19	I/O	SPI2 clock / General Purpose I/O	FSPICLK / GPIO19	
B3	FSPICS0 / GPIO23	I/O	SPI2 Chip select / General Purpose I/O	FSPICS0 / GPIO23	
B4	GPIO6/ MTCK	I/O	JTAG Test clock / General Purpose I/O	MTCK / GPIO6	Analog-capable pin LP option (LP_GPIO6 / LP_I2C_SDA)
B5		NC			
B6	XTAL_32K_N/ GPIO1	I/O	32KHz external clock input / General Purpose I/O	GPIO1	Analog-capable pin. LP option (LP_GPIO1 / LP_UART_DSRN)
B7	VCCIO	I	Module I/O level voltage input		VIO voltage supply.
B9		NC			
C1	FSPIQ / GPIO20	I/O	SPI2 Master Input Slave Output / General Purpose I/O	FSPIQ / GPIO20	
C2	FSPID / GPIO18	I/O	SPI2 Master Output Slave Input / General Purpose I/O	FSPID / GPIO18	
C4		NC			
C5		NC			
C6	XTAL_32K_P / GPIO0	I/O	32KHz external clock input / General Purpose I/O	GPIO0	Analog-capable pin. LP option (LP_GPIO0 / LP_UART_DTRN)
C8	USB_P / GPIO13	I/O	USB differential data signal / General Purpose I/O	USB_D+ / GPIO13	Analog-capable pin. Default drive capability of this pin is ~40mA
C9	USB_P / GPIO13	I/O	USB differential data signal / General Purpose I/O	USB_D+ / GPIO13	Analog-capable pin. Default drive capability of this pin is ~40mA
D1		NC			
D2		NC			
D3	FSPIHD / GPIO22	I/O	SPI2 Hold / General Purpose I/O	FSPIHD / GPIO22	
D7		NC			
D8	USB_N / GPIO12	I/O	USB differential data signal / General Purpose I/O	USB_D- / GPIO12	Analog-capable pin. Default drive capability of this pin is ~40mA
D9	USB_N / GPIO12	I/O	USB differential data signal / General Purpose I/O	USB_D- / GPIO12	Analog-capable pin. Default drive capability of this pin is ~40mA
E1		NC			
E2		NC			

¹ I/O notations: I=Input, O=Output, I/O=Input or Output, PU=Pull Up, PD=Pull Down, D=Default, PP=Push-Pull, OD=Open Drain, AI/AO=Analog Input/Output, NC=Not Connected

No.	NORA function	I/O ¹	Description	ESP32-C6 function	Remarks
E3		NC			
E7		NC			
E8	WAKE_HOST / GPIO2	I/O	General Purpose I/O	GPIO2	Analog-capable pin. LP option (LP_GPIO2 / LP_UART_RTSN)
E9	GPIO14	I/O	General Purpose I/O	GPIO14	
F1		NC			
F2		NC			
F3		NC			
F7	PBOOT / GPIO9	I/O	General Purpose I/O	Boot / GPIO9	
F8	FSPIWP / GPIO21	I/O	SPI2 Write Protect / General Purpose I/O	FSPIWP / GPIO21	
F9	FSPIHD / GPIO22	I/O	SPI2 Hold / General Purpose I/O	FSPIHD / GPIO22	
G1	MTDO / GPIO7	I/O	JTAG Test Data Out /	MTDO / GPIO7	LP option (LP_GPIO7 / LP_I2C_SCL)
G2		NC			
G3		NC			
G4		NC			
G5		NC			
G7		NC			
G8	U0TXD / GPIO16	I/O	UART data output / General Purpose I/O	U0TXD / GPIO16	
G9	U0RXD / GPIO17	I/O	UART data input / General Purpose I/O	U0RXD / GPIO17	
H1	MTDI / GPIO5	I/O	JTAG Test Data In (debug interface) / General Purpose I/O	MTDI / GPIO5	Analog-capable pin. LP option (LP_GPIO5 / LP_UART_TXD)
H2	MTMS / GPIO4	I/O	JTAG Test Mode Select / General Purpose I/O	MTMS / GPIO4	Analog-capable pin. LP option (LP_GPIO4 / LP_UART_RXD)
H3		NC			
H7		NC			
H8	PBOOT / GPIO9	I/O	General Purpose I/O	Boot / GPIO9	
H9	GPIO15	I/O	General Purpose I/O	GPIO15	
J1		NC			
J2	MTCK / GPIO6	I/O	JTAG Test clock / General Purpose I/O	MTCK / GPIO6	Analog-capable pin. LP option (LP_GPIO6 / LP_I2C_SDA)
J3	RESET_N	I	External system reset input.	RESET	Active low
J4		NC			
J5		NC			
J7		NC			
J8	SBOOT / GPIO8	I/O	General Purpose I/O	Boot / GPIO8	
J9	WAKE_UP/GPIO 3	I/O	General Purpose I/O	GPIO3	Analog-capable pin LP option (LP_GPIO3 / LP_UART_CTSN)
K1		NC			
K9	ANT	I/O	Antenna Tx/Rx interface	LNA_IN	50 Ω nominal characteristic impedance, only used with NORA-W401 modules.

No.	NORA function	I/O ¹	Description	ESP32-C6 function	Remarks
					NC for NORA-W406
	EGP	-	Exposed Ground Pins		Exposed scattered grey pins on the module should be connected to GND
L1-M9	EAGP	-	Exposed Antenna Ground Pins		Exposed pins underneath the antenna area should be connected to GND

Table 4: NORA-W40 pin-out

 The LP, low power, mode option is used to save power with limited functionality. For more information see the ESP32-C6 data sheet [\[3\]](#).

4 Electrical specifications

Stressing the device above one or more of the [Absolute maximum ratings](#) can cause permanent damage. These are stress ratings only. Operating the module at these or at any conditions other than those specified in the [Operating conditions](#) should be avoided. Exposure to absolute maximum rating conditions for extended periods may affect device reliability.

All given application information is only advisory and does not form part of the specification.

4.1 Absolute maximum ratings

Symbol	Description	Condition	Min	Max	Unit
VCC/VCC_IO	Module supply voltage	Input DC voltage at VCC and VCC_IO pins	-0.3	3.6	V
I _{VCC MAX} + I _{VCC_IO MAX}	Absolute maximum power consumption			500	mA
DPV	Digital pin voltage	Input DC voltage at any digital I/O pin	-0.3	3.6	V
P_ANT	Maximum power at receiver	Input RF power at antenna pin		0	dBm
Tstr	Storage temperature		-40	+85	°C

Table 5: Absolute maximum ratings

The product is not protected against overvoltage or reversed voltages. If necessary, voltage spikes exceeding the power supply voltage specification shown in [Table 5](#) must be limited to values within the specified boundaries by using appropriate protection devices.

4.1.1 Maximum ESD ratings

Parameter	Min.	Typical	Max.	Unit	Remarks
ESD immunity			±8*	kV	Indirect discharge according to IEC 61000-4-2
ESD sensitivity, tested for all pins except ANT pin.			2.5	kV	Human body model according to JEDEC JS001

* Tested on EVK-NORA-W10 evaluation board.

Table 6: Maximum ESD ratings

NORA-W40 series modules are Electrostatic Sensitive Devices, which means that some special precautions must be observed when handling them. See also [ESD precautions](#).

4.2 Operating conditions

Operation beyond the specified operating conditions is not recommended and extended exposure beyond them can affect device reliability.

Unless otherwise specified, all operating condition specifications are at an ambient temperature of 25 °C and at a supply voltage of 3.3 V.

4.2.1 Operating temperature range

Parameter	Min	Max	Unit
Operating temperature	-40	+85	°C

Table 7: Temperature range

4.2.2 Supply/Power pins

Symbol	Parameter	Condition	Min	Typ	Max	Unit
VCC	Input supply voltage	Ambient temperature	3.00	3.30	3.60	V
VCC_IO	I/O reference voltage	Ambient temperature	3.00	3.30	3.60	V

Table 8: Input characteristics of voltage supply pins

4.2.3 RESET_N pin

Figure 3 shows the conditions for VCC and RESET_N timing during start-up and reset duration. The pin characteristics are described in Table 9.

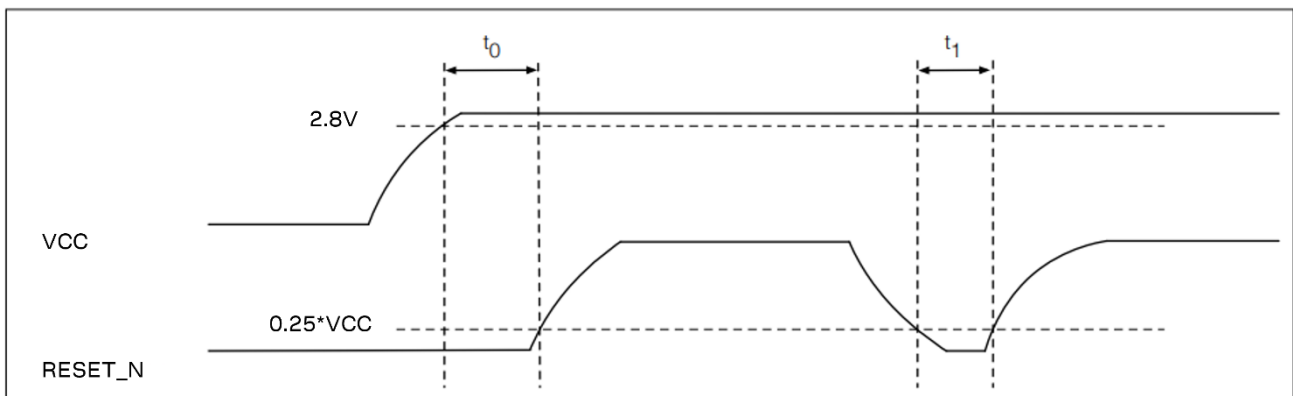

Figure 3: Module power-up and reset timing

Pin name	Parameter	Min	Typ	Max	Unit
RESET_N	Low-level input	-0.3		0.25*VCC	V
	Internal pull-up resistance		45		kΩ
	Internal capacitance		10		nF
t ₀	Time from VCC valid input level 2.8 V to RESET_N release reaches 0.25*VCC	50	1000		μs
t ₁	Duration of RESET_N pin < low level input 0.25*VCC, to trigger hardware reset	50			μs

Table 9: RESET_N pin characteristics.

In case of slow ramp-up, frequent power on and off, or unstable power supply (e.g., battery charging, photovoltaic systems) consider using an external reset chip or a watchdog timer IC set to around 3.0 V to boot correctly.

4.2.4 LPO clock

NORA-W40 series modules do not have an internal low power oscillator (LPO) or crystal for low power modes. If low power modes are required, the LPO signal can be supplied to the **LPO_IN** pin from an external oscillator. Alternatively, an external low frequency crystal can also be attached to **XTAL_32K_N** and **XTAL_32K_P** pins.

The amplitude range is $0.6\text{ V} < V_{pp} < V_{CC_IO}$. If the input signal is square wave the bottom voltage should be higher than 200 mV.

Symbol	Parameter	Min	Typ	Max	Unit
LPO	Input clock frequency		32.768		kHz
	Input slow clock accuracy (Initial + temp + aging)			±150	ppm
Tr/Tf	Input transition time Tr/Tf -10% to 90%			100	ns
	Frequency input duty cycle	20	50	80	%
VIH	Input voltage limits			VCC_IO	V
VIL	(Square wave, DC-coupled)	0		0.6	V
	Input capacitance			10	pF

Table 10: External LPO clock characteristics

4.2.5 Digital pins

Pin name	Parameter	Min	Typ	Max	Unit	Remarks
Any digital pin	Input characteristic: Low-level input	0		0.3*VCC_IO	V	
	Input characteristic: high-level input	0.7*VCC_IO		VCC_IO	V	
	Output characteristic: Low-level output	0		0.4	V	
	Output characteristic: High-level output	VCC_IO-0.4		VCC_IO	V	
	Drive capability			20	mA	Source/Sink
	Pull-up/pull-down resistance		45		kΩ.	
Signals rerouted through the IO MUX	Output signal speed			20	MHz	
	Input signal speed			10	MHz	The GPIO matrix delays the input signals by two cycles of the AHB clock, which typically introduces an 80 MHz -> 25 ns delay.

Table 11: Digital pin characteristics

4.2.6 Current consumption

The typical current consumption of a NORA-W40 module is shown in [Table 12](#). The current consumption is highly dependent on the application implementation. All measurements taken with 3.3 V supply at 25 °C.

The current consumption figures are inherited from the Espressif ESP 32-C6 data sheet [\[3\]](#).

Power mode	Activity	Peak	Unit	Remarks
Wi-Fi	Wi-Fi Tx 802.11b 1Mbit/s @ 20 dBm	354	mA	100% duty cycle
	Wi-Fi Tx 802.11g 54Mbit/s @ 17 dBm	300	mA	
	Wi-Fi Tx 802.11n HT20 MCS7 @ 16.5 dBm	280	mA	
	Wi-Fi Tx 802.11n HT40 MCS7 @ 16.5 dBm	268	mA	
	Wi-Fi Tx 802.11ax MCS9 @ 16.5 dBm	252	mA	
	Wi-Fi Rx 802.11b/g/n/ax	78	mA	
Bluetooth LE	Bluetooth Tx Pout 0 dBm	130	mA	100% duty cycle
	Bluetooth Rx and listening	71	mA	
	CPU speed 160 MHz, dual core	27	mA	Immediate wake-up
	CPU speed 80 MHz, dual core	19	mA	
Light-sleep mode	VDD_SPI and Wi-Fi are powered down, and all GPIOs are high impedance.	180	µA	
Deep-sleep mode	RTC memory and RTC peripherals are powered on	7	µA	
Power off mode	CHIP_PU is set to low level. The chip is powered off	1	µA	

Table 12: Current consumption during typical use cases

4.2.7 Wi-Fi characteristics and absolute maximum radio performance

$V_{CC} = 3.3\text{ V}$, $T_{amb} = 25\text{ °C}$

Parameter	Operating mode	Specification	Unit
RF frequency range	802.11b/g/n/ax	2.400 – 2.484	GHz
Modulation	802.11b	CCK and DSSS	
	802.11g/n	OFDM	
	802.11ax	OFDMA	
Supported data rates	802.11b	1, 2, 5.5, 11	Mbit/s
	802.11g	6, 9, 12, 18, 24, 36, 48, 54	Mbit/s
	802.11n	MCS0 – MCS7	
	802.11ax	MCS0 – MCS9	
Supported bandwidth	802.11n	20,40	MHz
	802.11ax	20	MHz
Supported guard interval	802.11b/g/n	400	ns
	802.11ax	800, 1600, 3200	ns

Table 13: Wi-Fi radio characteristics

NORA-W40 series modules support Wi-Fi 802.11b/g/n/ax operation in the 2.4 GHz band. Maximum transmitter output power values are supported only in certain regions – depending upon the certification approval. For typical radio performance data, see [Radio performance](#).

Table 14 shows the maximum (conducted) transmitter output power and receiver sensitivity for supported modes of operation.

Parameter	Operating mode	Data rate	Specification (dBm)	Bandwidth	802.11 EVM limit (dBm)
Conducted Transmit Power	802.11b	1 Mbit/s	20 ± 1	20 MHz	-21 dBm
		11 Mbit/s	20 ± 1		-21 dBm
	802.11g	6 Mbit/s	20 ± 1	20 MHz	-20 dBm
		54 Mbit/s	18.5 ± 1		-26.5 dBm
	802.11n	MCS0	19 ± 1	20 MHz	-21.5 dBm
			18 ± 1		-28.5 dBm
		MCS7	18.5 ± 1	40 MHz	-23.5 dBm
			17 ± 1		-28.5 dBm
	802.11ax	MCS0	19 ± 1	HE20	-29.0 dBm
		MCS9	15 ± 1		-34.0 dBm
Receiver Sensitivity	802.11b	1 Mbit/s	-99 ± 2	20 MHz	N/A
		11 Mbit/s	-89 ± 2		N/A
	802.11g	6 Mbit/s	-94 ± 2	20 MHz	N/A
		54 Mbit/s	-77 ± 2		N/A
	802.11n	MCS0	-93.5 ± 2	20 MHz	N/A
			-74 ± 2		N/A
		MCS7	-91 ± 2	40 MHz	N/A
			-72 ± 2		N/A
	802.11ax	MCS0	-93.5 ± 2	HE20	N/A
		MCS9	-68 ± 2		HE20

* There is lower output power on band edge channels

Table 14: Wi-Fi radio maximum transmitter and receiver power parameter

Maximum transmitter output power values are supported only in certain regions – depending upon the certification approval. For typical radio performance data, see [Radio performance](#).

4.2.8 Bluetooth Low Energy characteristics and absolute maximum radio performance

$V_{CC} = 3.3 \text{ V}$, $T_{amb} = 25 \text{ }^\circ\text{C}$

Parameter	Specification	Unit
RF Frequency Range	2.400 – 2.4835	GHz
Supported Modes	Bluetooth v5.3	
Number of channels	40	
Modulation	GFSK	
Transmit Power (conducted)	20 ± 1	dBm
Receiver Sensitivity	-98 ± 2	dBm

Table 15: Bluetooth Low Energy characteristics

Maximum transmitter output power value is only supported in certain regions, depending upon the certification approval. For typical radio performance data, see [Radio performance](#).

4.2.9 Antenna radiation patterns

Figure 4 provides an overview of the measurement procedure and describes how NORA-W106 module with integrated PCB trace antenna is aligned to the XYZ-coordinate system.

A measurement is taken at every dotted position above the module image (shown left). Each measurement is represented as a grid point in the radiation pattern (shown right). NORA-W406 module will have similar radiation pattern.

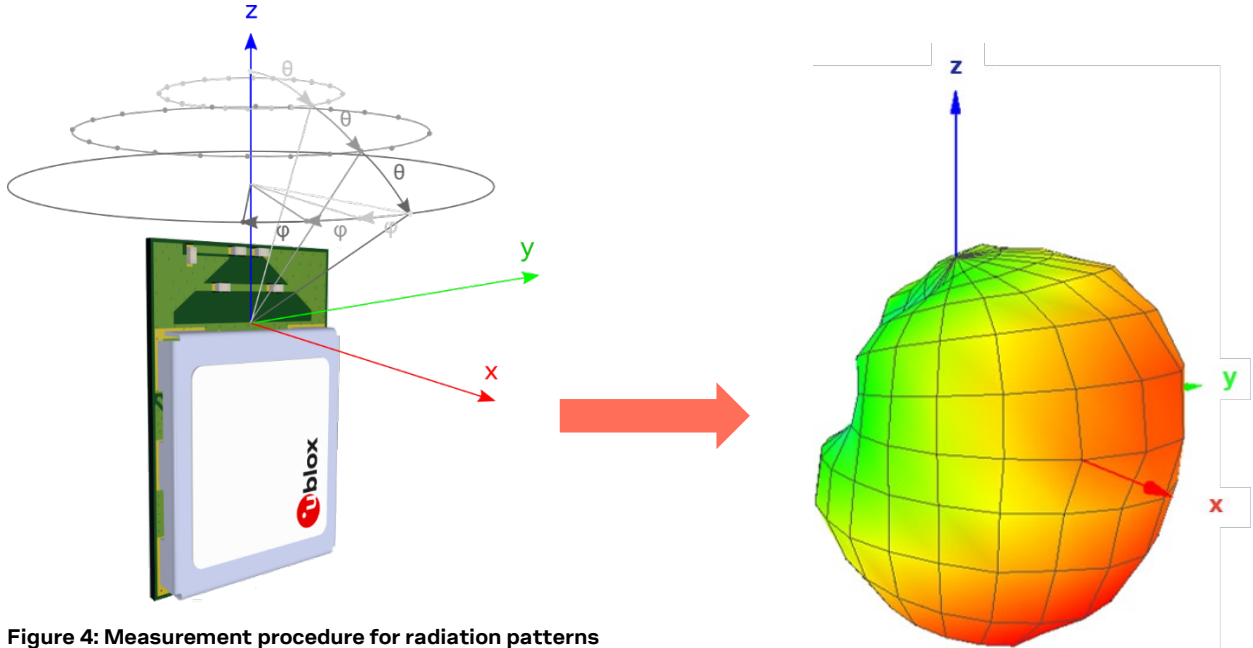
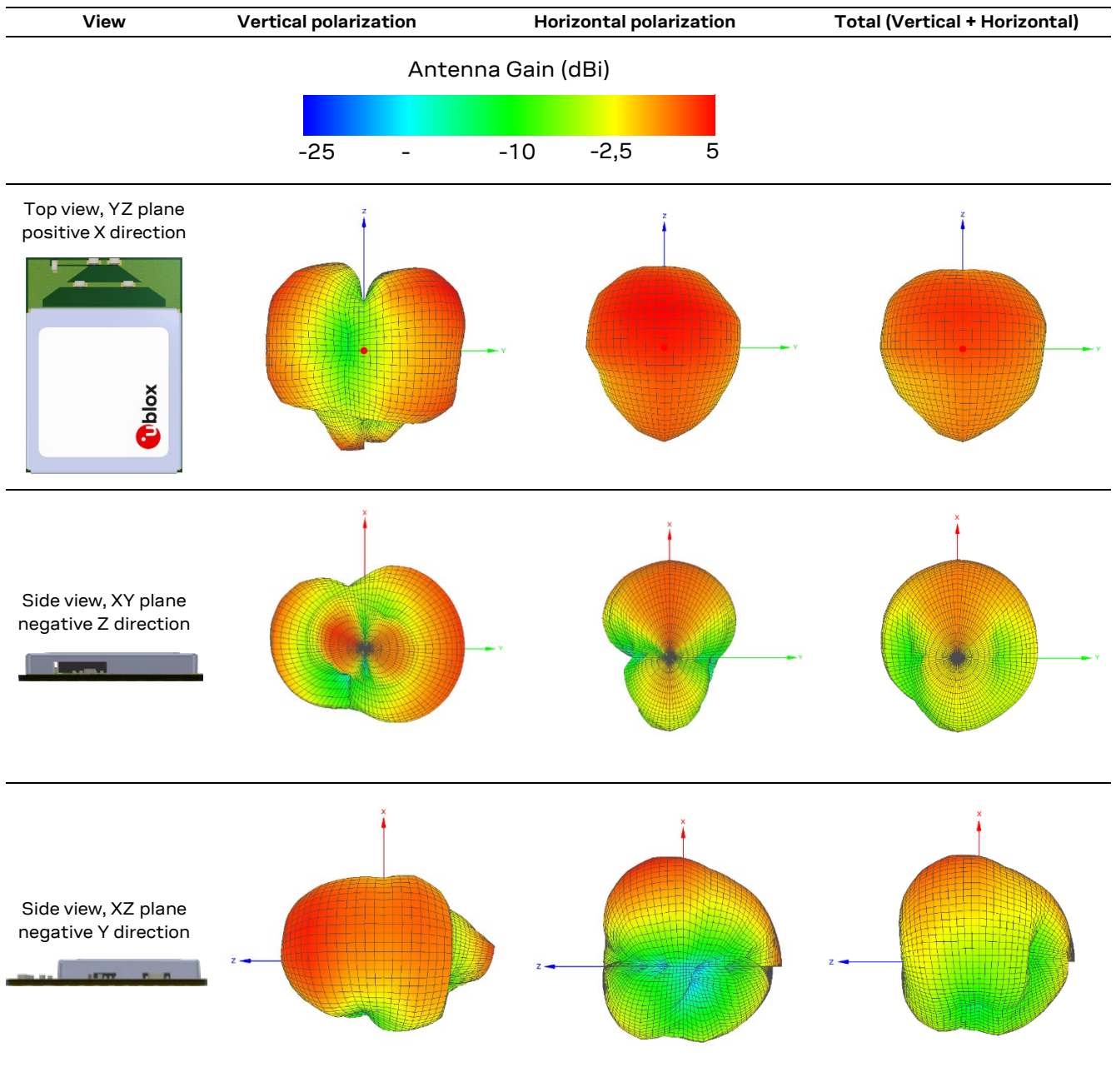

Figure 4: Measurement procedure for radiation patterns

Table 16 shows the displayed radiation patterns of the internal PCB trace antenna on NORA-W406.



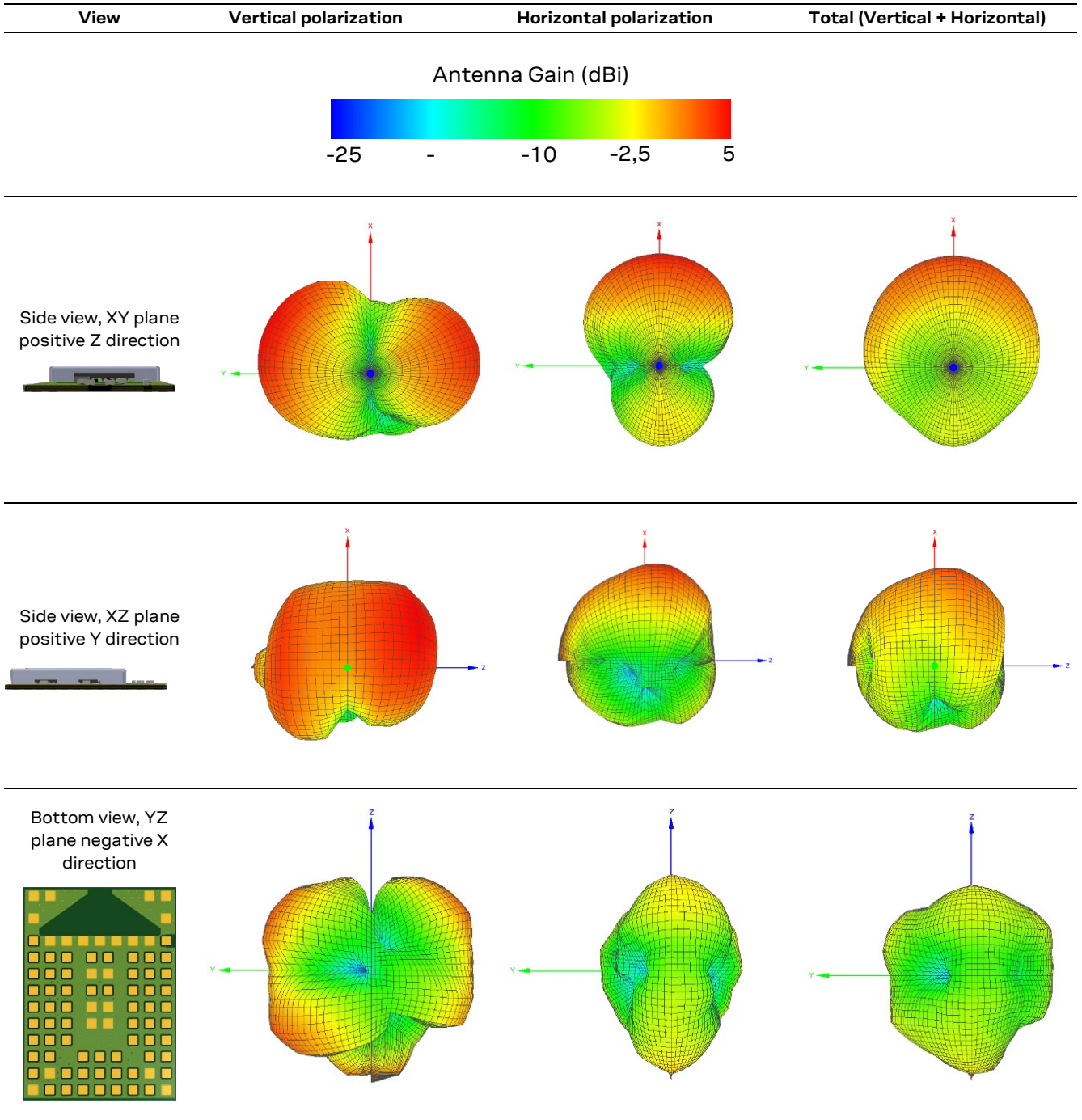

Table 16: NORA-W406 antenna radiation patterns

5 Mechanical specifications

5.1 NORA-W401/W406 mechanical specifications

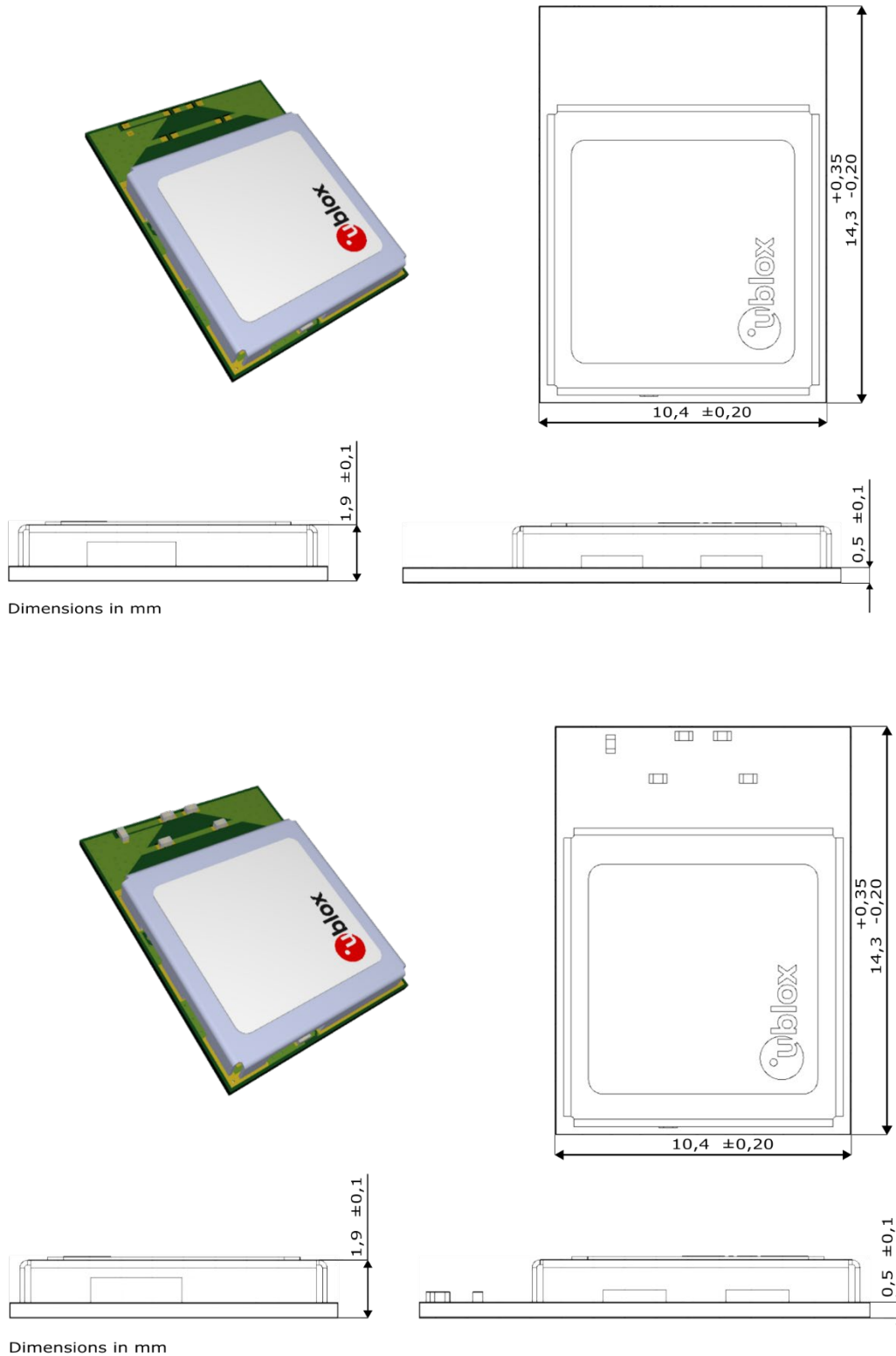

Figure 5: NORA-W401 and NORA-W406 dimensions

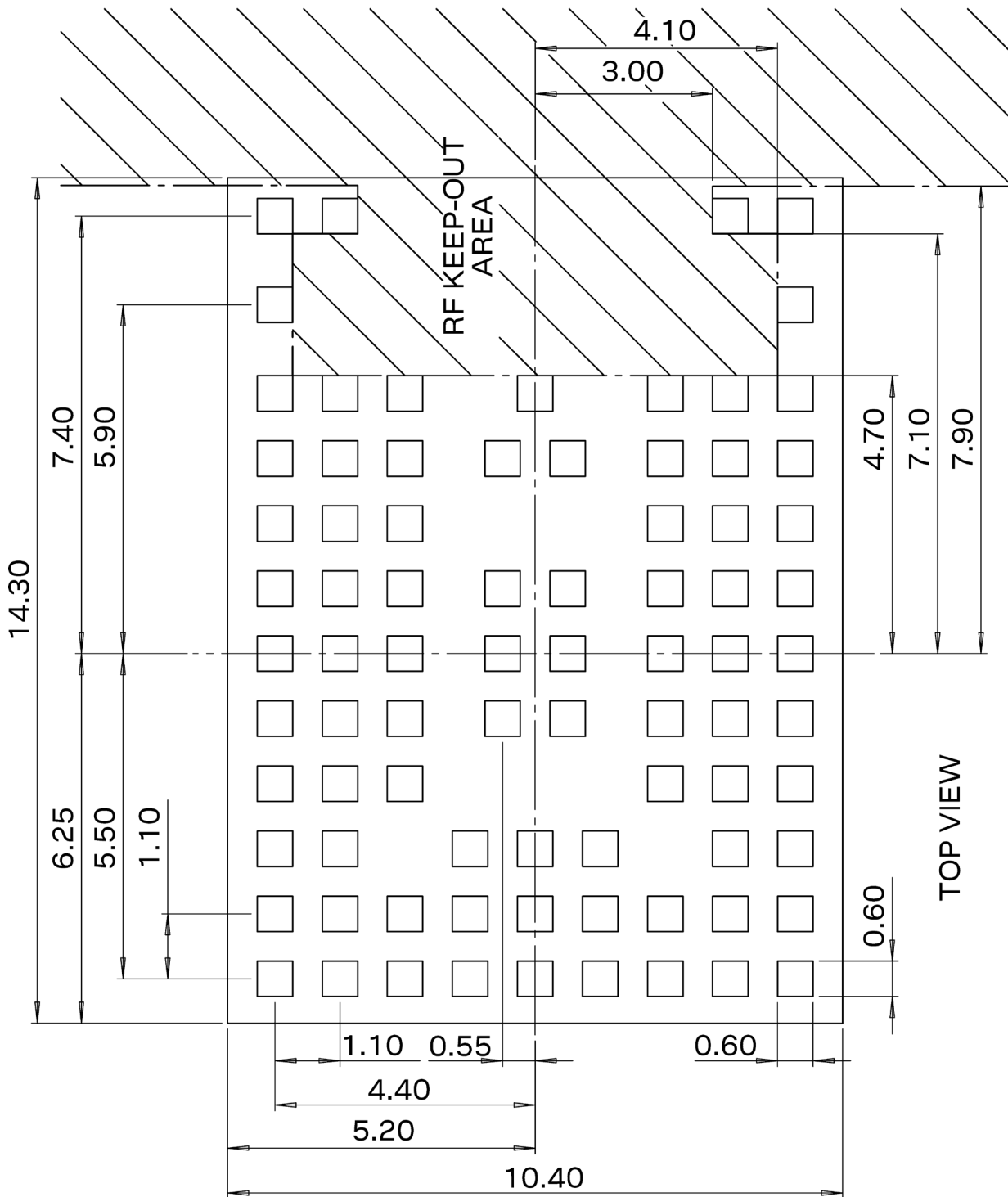

Figure 6: NORA-W401 mechanical outline

6 Qualification and approvals

6.1 Country approvals

The NORA-W40 module series will be certified for use in the following countries/regions:

Country/region	NORA-W401-00B	NORA-W406-00B	NORA-W401-10B	NORA-W406-10B
Europe (RED)	Pending	Pending	Pending	Pending
Great Britain (UKCA)	Pending	Pending	Pending	Pending
USA (FCC)	Pending	Pending	Pending	Pending
Canada (ISED)	Pending	Pending	Pending	Pending
Japan (MIC)	Pending	Pending	Pending	Pending
Taiwan (NCC)	Pending	Pending	Pending	Pending
South Korea (KCC)	Pending	Pending	Pending	Pending
Australia and New Zealand (ACMA)	Pending	Pending	Pending	Pending

Table 17: Country approvals for NORA-W40

For detailed information about the regulatory requirements that must be met when using NORA-W40 modules in an end product, see the NORA-W40 system integration manual [\[1\]](#).

6.2 Bluetooth qualification information



End products must be qualified and listed with the [Bluetooth Special Interest Group \(SIG\)](#). Product declarations are submitted through the SIG [Bluetooth SIG Qualification Workspace](#).

NORA-W40 module series are qualified as Core-Controller Configuration in accordance with the Bluetooth 5.3 specification and are registered with the SIG Qualified Design IDs (QD ID) shown in [Table 18](#).

Model	Product type	QDID	Listing date
NORA-W401-00B	Core-Controller Configuration	-	
NORA-W406-00B	Core-Controller Configuration	-	
NORA-W401-10B	Core-Controller Configuration	-	
NORA-W406-10B	Core-Controller Configuration	-	

Table 18: NORA-W401/NORA-W406 Bluetooth QD ID

The Espressif IoT development framework for ESP-IDF currently supports two host Bluetooth stacks: Bluedroid and Apache NimBLE for Bluetooth LE. For further listing information, search the Bluetooth SIG Qualification Workspace.

7 Product handling

7.1 Packaging

NORA-W40 series modules are delivered as hermetically sealed, reeled tapes to enable efficient production, production lot set-up and tear-down. See also the Product packaging guide [2].

7.1.1 Reels

NORA-W40 modules are delivered in quantities of 500 pieces on a reel. The reel types for NORA-W40 modules are shown in Table 19. See also the Product packaging guide [2].

Model	Reel type
NORA-W401	A3
NORA-W406	A3

Table 19: Reel types for different NORA-W40 series modules

7.1.2 Tapes

Figure 7 and Figure 8 show the position and orientation of NORA-W40 modules as they are delivered on tape. The dimensions of the tapes are specified in Figure 7 and Figure 8.



Figure 7: NORA-W401 module on tape orientation



Figure 8: NORA-W406 module on tape orientation

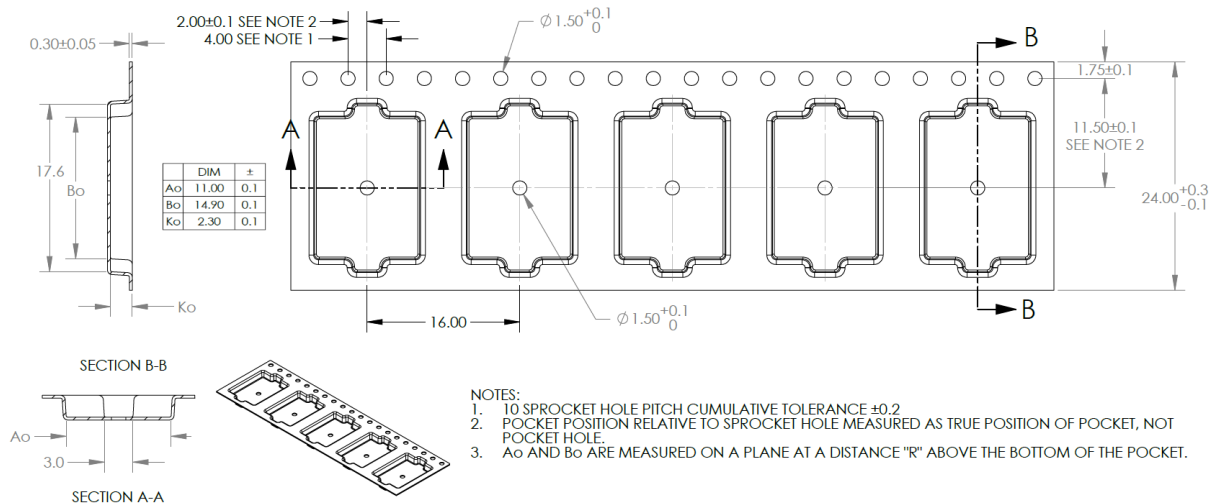

Figure 9: NORA-W401/NORA-W406 tape dimensions

7.2 Moisture sensitivity levels

NORA-W40 modules are rated as Moisture Sensitivity Level (MSL) Level 4 devices in accordance with the IPC/JEDEC J STD-020 standard. For more information, see the moisture sensitive warning label on the MBB (Moisture Barrier Bag).

After opening the dry pack, the modules must be mounted within 168 hours in factory conditions of maximum 30 °C/60% RH or must be stored at less than 10% RH. The modules require baking if the humidity indicator card shows more than 10% when read at 23±5 °C or if the conditions mentioned above are not met. For information about the bake procedure, see also the J-STD-033 standard.

For more information regarding MSL (Moisture Sensitivity Level), labeling, and storage, see also the Product packaging guide [2].

7.3 Reflow soldering

NORA-W40 modules are approved for two reflow processes only.

- ⚠ Reflow profiles must be selected in accordance with u-blox soldering recommendations described in the NORA-W40 system integration manual [1]. Failure to observe these recommendations can result in severe damage to the device.

7.4 ESD precautions

NORA-W40 modules are Electrostatic Sensitive Devices (ESD) that demand the observance of special handling precautions against static damage. Failure to observe these precautions can result in severe damage to the product. See also [Maximum ESD ratings](#).

Proper ESD handling and packaging procedures must be applied throughout the processing, handling, and operation of any application that incorporates the module. ESD precautions are also relevant when handling the application board on which the module is mounted.

For further information about the handling of NORA-W40 modules, see also the system integration manual [1].

8 Labeling and ordering information

8.1 Product labeling

The labels (8x8 mm) of the NORA-W40 series modules described in the section include important product information.

Figure 10 shows the label of all the NORA-W40 series modules, which includes product type number and revision, production date, and data matrix that bears a unique serial number and the u-blox logo.

All units in mm unless specified otherwise specified.

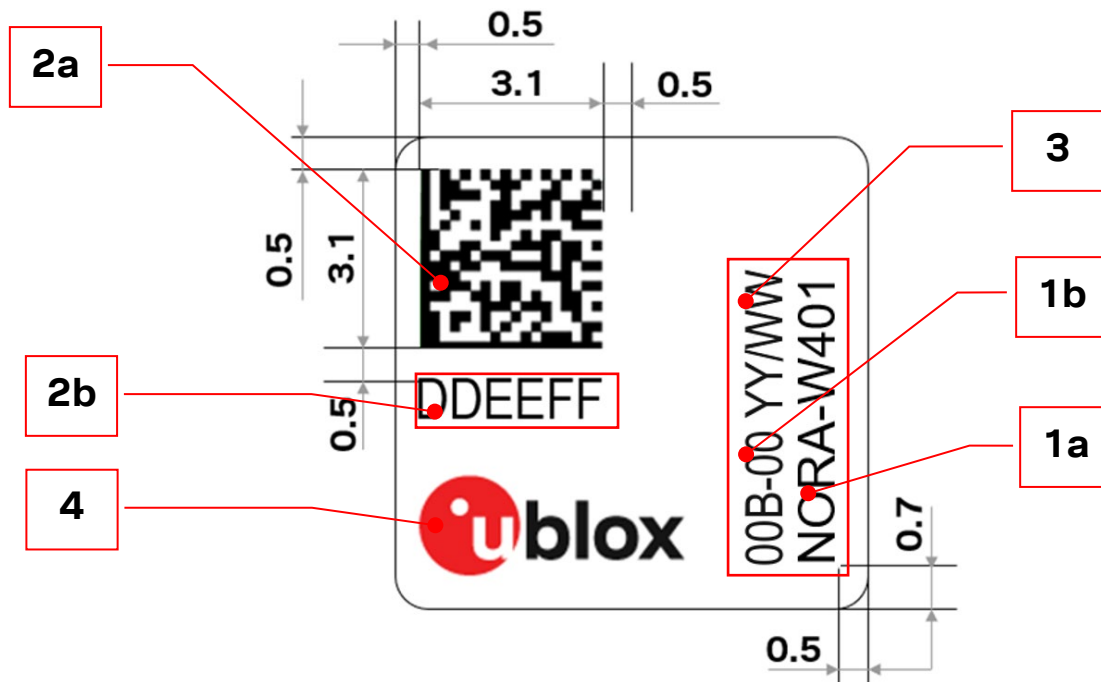

Figure 10: Location of product type number on the NORA-W40 series module label

Reference	Description
1a	Text box containing Product Name and approval ID:s (Applicable model names: NORA-W4xx).
1b	Product type number.
2a	Data Matrix with unique serial number comprising 19 alphanumeric digits: (product identifier, serial number, datacode) <ul style="list-style-type: none"> Product identifier: 3 digits, used for production tracking and are an abbreviated representation of the Type number that is unique to each module variant Serial number: 12 digits, Unique MAC address assigned during module production. Datacode: 4 digits, Represent the hardware and firmware version encoded.
2b	The six last hex symbols of the MAC address (AABBCCDDEEFF).
3	Date of production encoded YY/WW (year/week).
4	u-blox logo. The red dot also indicates pin 1.

Table 20: NORA-W40 series label description

8.2 Product identifiers

[Table 21](#) describes the three product identifiers, namely the Type number, Model name and Ordering code.

Format	Description	Nomenclature
Model name	Describes the form factor, platform technology and platform variant. Used mostly in product documentation like this data sheet, the model name represents the most common identity for all u-blox products	PPPP-TGVV
Ordering code	Comprises the model name – with additional identifiers to describe the major product version and quality grade	PPPP-TGVV-TTQ
Type number	Comprises the model name and ordering code – with additional identifiers to describe minor product versions.	PPPP -TGVV-TTQ-XX

Table 21: Product code formats

8.3 Identification codes

[Table 22](#) describes the individual identification codes represented in each product identifier.

Code	Meaning	Example
PPPP	Form factor	NORA
TG	Platform (Technology and Generation) T – Dominant technology, For example, W: Wi-Fi, B: Bluetooth G – Generation	W4: Wi-Fi Generation 4
VV	Variant based on the same platform; range [00...99]	01: product with antenna pin
TT	Major Product Version	00: first revision
Q	Quality grade A: Automotive B: Professional C: Standard	B: professional grade
XX	Minor product version (not relevant for certification)	Default value is 00

Table 22: Part identification code

8.4 Ordering information

Ordering code	Product
NORA-W401-00B	Module with antenna pin. Open CPU version. Using ESP32-C6FH4 including 4MB embedded flash with Quad SPI.
NORA-W406-00B	Module with internal PCB trace antenna. Open CPU version. Using ESP32-C6FH4 including 4MB embedded flash with Quad SPI.
NORA-W401-10B	Module with antenna pin. Open CPU version. Using ESP32-C6FH8 including 8MB embedded flash with Quad SPI.
NORA-W406-10B	Module with internal PCB trace antenna. Open CPU version. Using ESP32-C6FH8 including 8MB embedded flash with Quad SPI.

Table 23: Product ordering codes

See also [Product variants](#).

Appendix

A Glossary

Abbreviation	Definition
ADC	Analog to Digital Converter
BPF	Band Pass Filter
BR/EDR	Basic rate/Enhanced data rate
CAN	Controller Area Network
CTS	Clear To Send
DAC	Digital to Analog Converter
DC	Direct Current
D/C	Don't Care
DSR	Data Set Ready
ESD	Electro Static Discharge
FCC	Federal Communications Commission
GATT	Generic ATtribute profile
GND	Ground
GPIO	General Purpose Input/Output
I2C	Inter-Integrated Circuit
I2S	Inter-IC Sound
IC	Industry Canada
LCD	liquid crystal display
IEEE	Institute of Electrical and Electronics Engineers
IoT	Internet of Things
LPO	Low Power Oscillator
MCU	Micro Controller Unit
MDIO	Management Data Input / Output
MII	Media-Independent Interface
MIMO	Multi-Input Multi-Output
MRD	Market Requirement Document
MSD	Moisture Sensitive Device
N/A	Not Applicable
PCN	Product Change Notification
RTS	Request To Send
RXD	Receive Data
SDIO	Secure Digital Input Output
SDK	Software Development Kit
SIM	System integration manual
SPI	Serial Peripheral Interface
TBD	To Be Defined
TWAI	Two-wire Automotive Interface
TXD	Transmit Data
UART	Universal Asynchronous Receiver/Transmitter

Table 24: Explanation of the abbreviations and terms used

Related documents

- [1] NORA-W40 series system integration manual, [UBXDOC-465451970-3233](#)
- [2] Product packaging reference, [UBX-14001652](#)
- [3] Espressif System ESP32-C6 [Data sheet](#)
- [4] Espressif System ESP32 [Data sheet](#)
- [5] Espressif System ESP32-S3 [Data sheet](#)
- [6] Espressif [API Reference guide](#)
- [7] NORA-W40 series product summary, [UBX-23009094](#)

 For product change notifications and regular updates of u-blox documentation, register on our website, www.u-blox.com.

Revision history

Revision	Date	Name	Comments
R01	01-Mar-2024	asoh, hekf	Initial release
R02	16-Sep-2025	asoh, hekf	NORA-W4x-10B version details updated. Description about USB/JTAG interface added. Product status updated to ES.

Contact

u-blox AG

Address: Zürcherstrasse 68
8800 Thalwil
Switzerland

For further support and contact information, visit us at www.u-blox.com/support.