

WD3168

5V/300mA Charge Pump Device

[Http://:www.sh-willsemi.com](http://www.sh-willsemi.com)

Descriptions

The WD3168 is a switched capacitor voltage converter which produces a regulated, low noise, and low-ripple output voltage (5V) from an unregulated input voltage. It maintains 5V regulation even when VIN is greater than 5V. The 5V output can supply a maximum of 300mA current with a small package.

WD3168 operates in skip-mode when the load current falls below 4mA under typical condition. In skip-mode operation, quiescent current is reduced to 170uA. Only 3 external capacitors are needed to generate output voltage, thereby saving PCB space. Inrush current is limited by the soft start function during power on and power transient states.

The WD3168 has built-in current limit protection that is ideal for HDMI, USB OTG and other battery powered applications. The WD3168 is available in Green SOT-23-6L package and is specified over an ambient temperature range of -40°C to +85°C.

Features

- Output Current up to 300mA
- Wide Input Voltage Range: 2.7V to 5.5V
- Fixed Output Voltage of 5.0V
- x2 Charge Pump
- Minimum External Components: No Inductors
- High Frequency Operation: 1.7MHz
- Automatic Soft Start Limits Inrush Current
- Low Ripple and EMI
- Thermal and Over Current Protection
- Typical 170uA Quiescent Current at no Load condition (Skip-mode)

Applications

- 3V to 5V Boost Conversion
- USB On-The-Go or HDMI 5V Supply
- Local 5V Supply from Lower Rail
- Battery Backup Systems
- Handheld Portable Devices

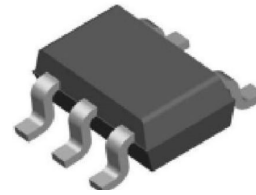

SOT-23-6L

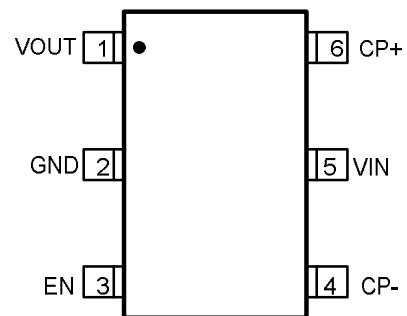

Pin configuration (Top view)

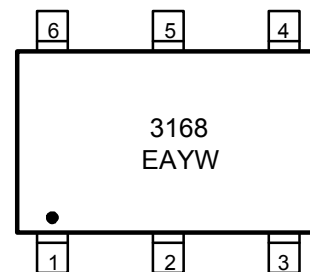

SOT-23-6L

3168 = Device code
EA = Special code
Y = Year code
W = Week code
Marking

Order Information

Device	Package	Shipping
WD3168E-6/TR	SOT-23-6L	3000/Reel&Tape

Pin configuration (Top view)

Symbol	Descriptions
CP+	Positive input for the external flying capacitor
CP-	Negative input for the external flying capacitor
VIN	Input power supply
EN	Enable control input (Active High)
GND	Ground reference for all voltages
VOU	Regulated Output Voltage (5V)

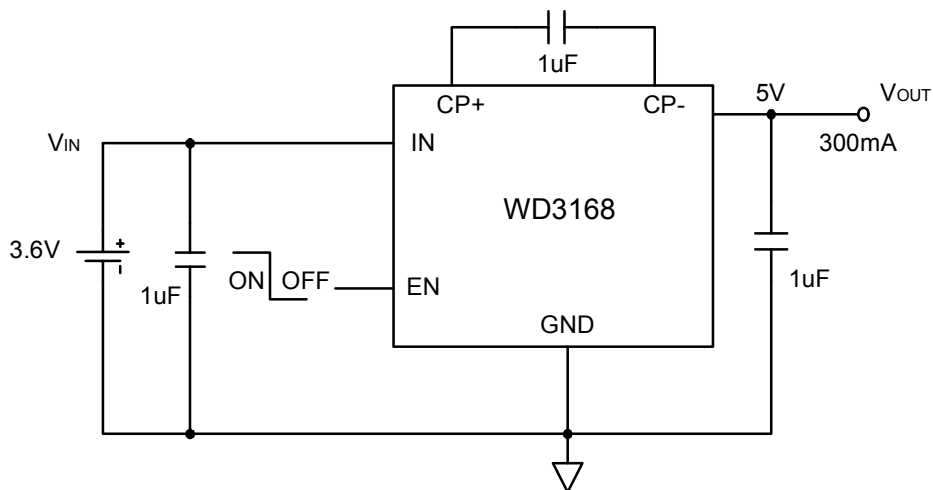
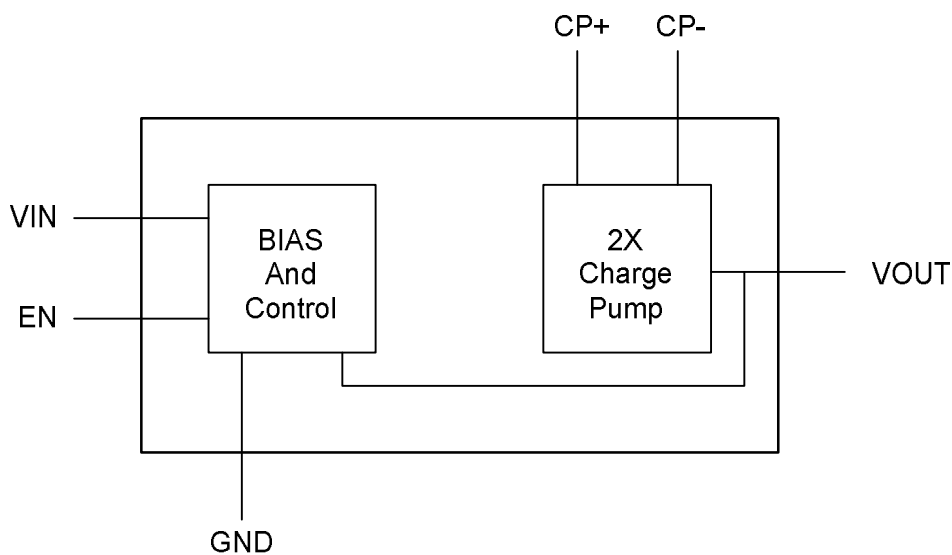
Typical applications

Block diagram

Absolute maximum ratings

Parameter	Symbol	Value	Unit
VIN,VOUT pin voltage range	V _{in}	-0.3~6	V
EN pin voltage range	V _{en}	-0.3~5.5	V
Output Current	I _{OUT}	500	mA
Power Dissipation (SOT-23-6L)	P	0.3	W
Junction to Ambient Thermal Resistance	R _{θJA}	200	°C/W
Junction temperature	T _J	150	°C
Lead temperature	T _L	260	°C
Operating ambient temperature	T _{opr}	-40 ~ 85	°C
Storage temperature	T _{stg}	-55 ~ 150	°C
ESD Ratings	HBM	4000	V
	MM	400	V

These are stress ratings only. Stresses exceeding the range specified under “Absolute Maximum Ratings” may cause substantial damage to the device. Functional operation of this device at other conditions beyond those listed in the specification is not implied and prolonged exposure to extreme conditions may affect device reliability.

Electronics Characteristics (Ta=25°C, V_{IN}=3.7V, C_{IN} = C_F = C_{OUT} = 1uF, unless otherwise noted)

Parameter	Symbol	Conditions	Min.	Typ.	Max.	Units
Input Voltage Range	V _{IN}		2.7		5.5	V
Regulated Output Voltage	V _{OUT}	V _{IN} =2.7V~5.5V I _{LOAD} =50mA	4.8	5.0	5.2	V
Line Regulation	V _{LINE}	V _{IN} =3.1V~4.5V I _{LOAD} =50mA		20		mV
Load Regulation	V _{LOAD}	I _{LOAD} =10mA~100mA		10		mV
Switching Frequency	f _{OSC}			1.7		MHz
Output Ripple Voltage	V _{RIPPLE}	I _{LOAD} =100mA		40		mVpp
Normal Output Current	I _{OUT-N}	V _{OUT} remains between 4.8V and 5.2V, V _{IN} =3.5V~5.5V		300		mA
Current Limit	I _{OUT-MAX}	V _{OUT} =4.5V			500	mA
Short Circuit Current	I _{OUT-S}	V _{OUT} =0V		90		mA
Normal Operating Quiescent Current	I _{Q-N}	I _{LOAD} =100mA		2		mA
Skip-mode Operating Quiescent Current	I _{Q-S}	I _{LOAD} =0mA		170		uA
Shutdown Current	I _{SHDN}	V _{IN} =2.7V~4.5V V _{EN} = 0V			1	uA
Charge Pump Equivalent Resistance (2X)	R _{ON}	V _{IN} =3.1V I _{LOAD} =200mA (Note 1)		6		Ω
Efficiency		V _{IN} =3.0V I _{LOAD} =100mA		80		%
EN Logic Low	V _{ENH}				0.4	V
EN Logic High	V _{ENL}	V _{IN} =2.7V~5.5V	1.3			V
EN Pin Pull-down Resistor	R _{EN}			2		MΩ
V _{OUT} Turn-on Time (10% to 90%)	T _{ON}	I _{LOAD} =100mA		150		uS
Thermal Shutdown	T _{SHDN}			150		°C
Thermal Recovery	T _{RC}			120		°C

1. $R_{ON} = (2V_{IN} - V_{OUT}) / I_{OUT}$

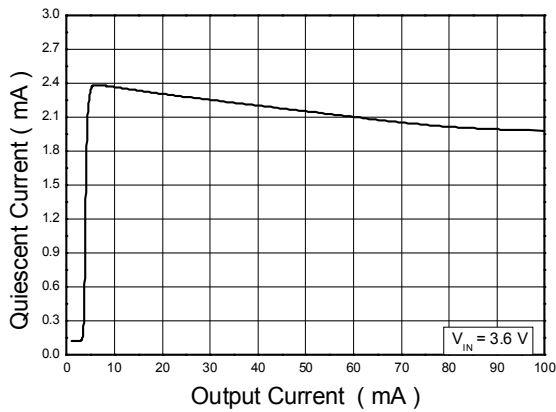
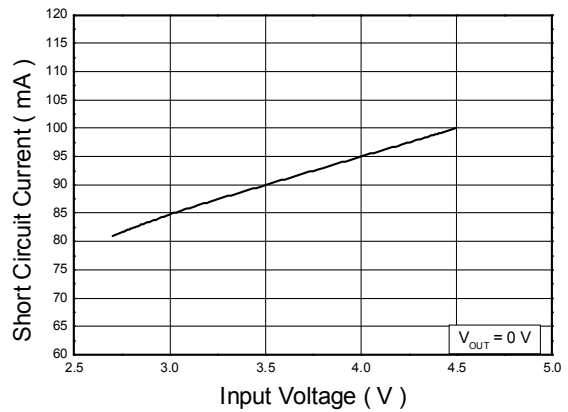
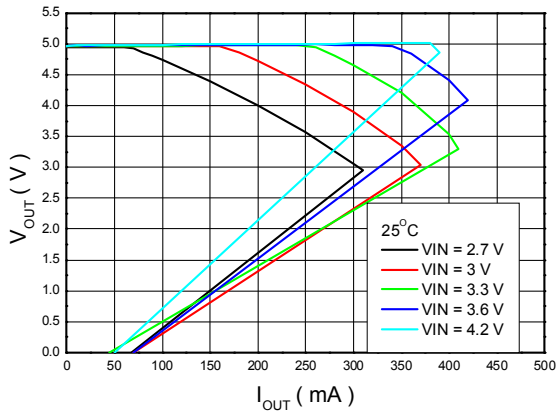
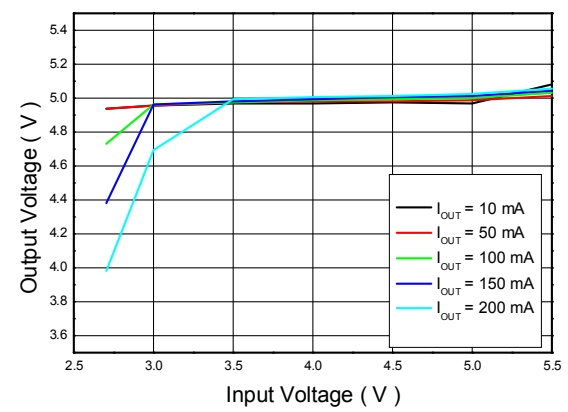
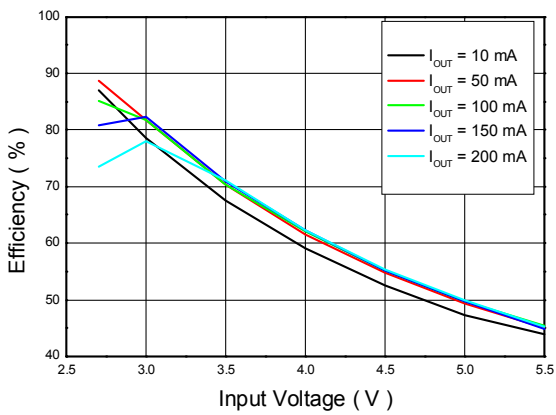
Typical Characteristics (Ta=25°C, V_{IN}=3.6V, C_{IN} = C_F = C_{OUT} = 1uF, unless otherwise noted)

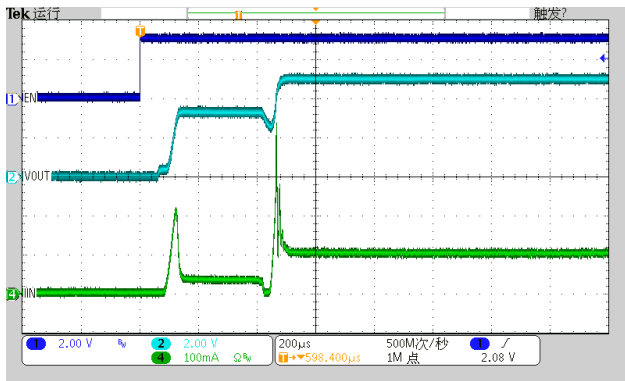
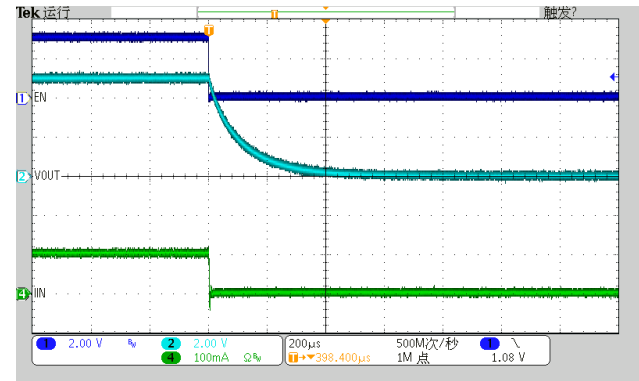
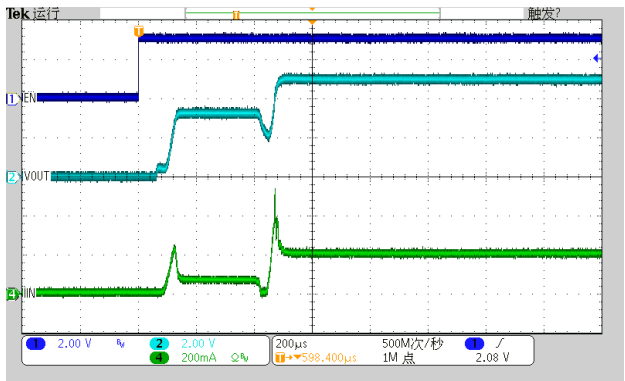
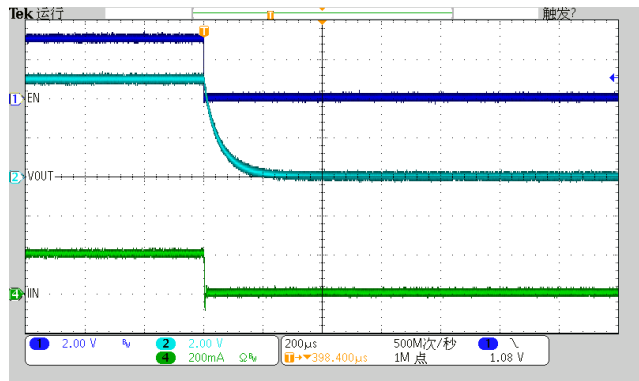
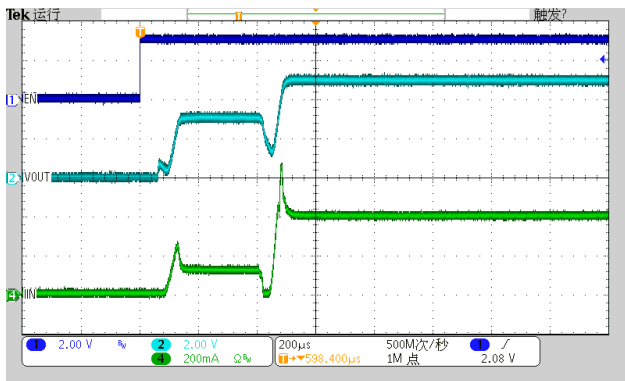
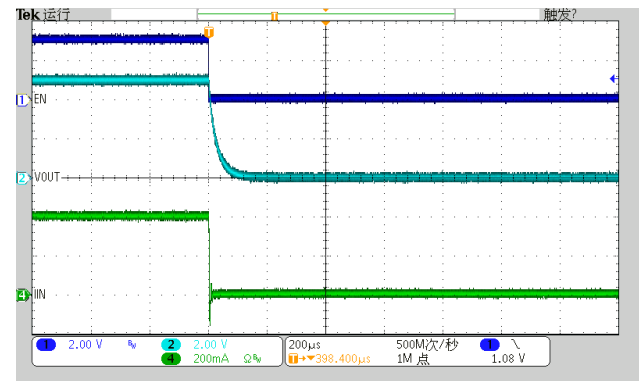
Quiescent Current vs. Output Current

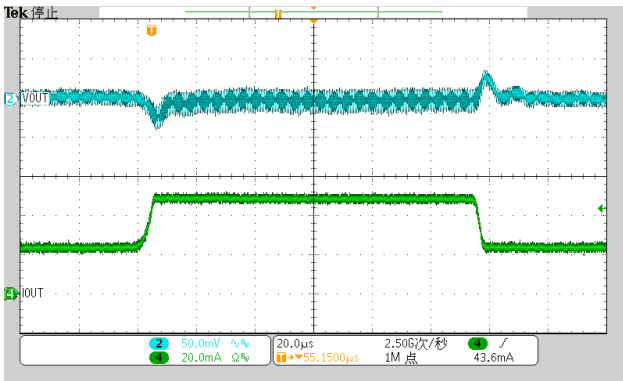
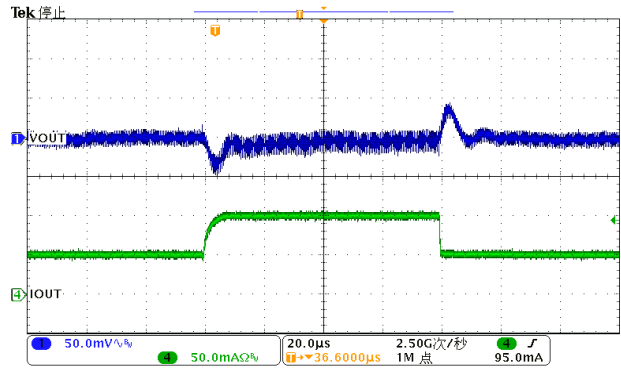
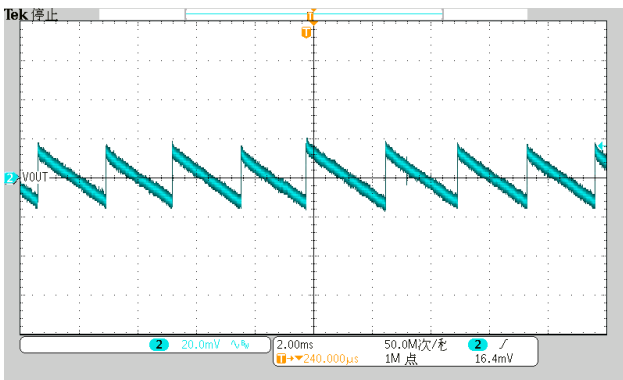
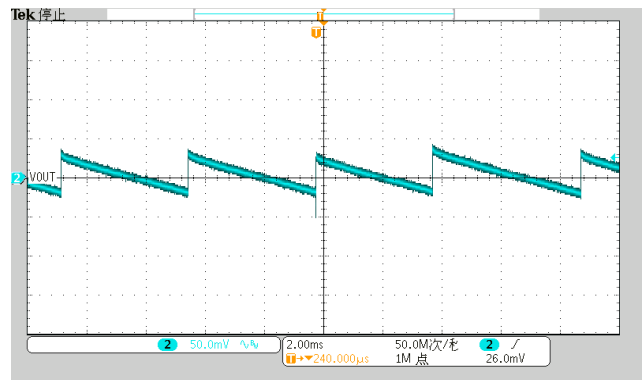
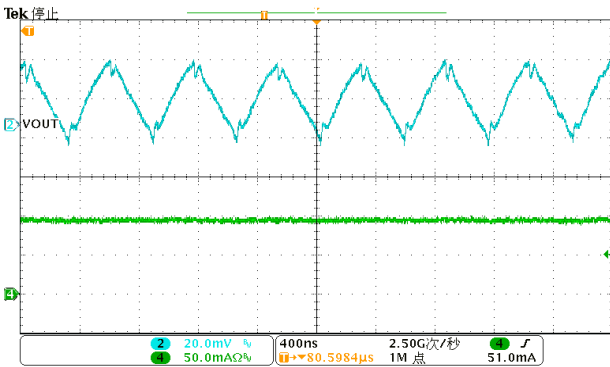
Short Circuit Current vs. Input Voltage

Output Voltage vs. Output Current

Output Voltage vs. Input Voltage

Efficiency vs. Input Voltage

Power-Up (EN L-to-H) VIN=3.3V, IOU=50mA

Power-Down (EN H-to-L) VIN=3.3V, IOU=50mA

Power-Up (EN L-to-H) VIN=3.3V, IOU=100mA

Power-Down (EN H-to-L) VIN=3.3V, IOU=100mA

Power-Up (EN L-to-H) VIN=3.3V, IOU=200mA

Power-Down (EN H-to-L) VIN=3.3V, IOU=200mA

Load transient response (IO=25mA-50mA)

Load transient response (IO=50mA-100mA)

Output ripple (VIN=2.7V, IO=0mA)

Output ripple (VIN=3.6V, IO=0mA)

Output ripple (IO=100mA)

Operation Information

The WD3168 uses a switched capacitor charge pump to boost the VIN voltage to a regulated output voltage. Regulation is achieved by sensing the output voltage through an internal resistor divider and modulating the charge pump output current based on the error signal. A two-phase non-overlapping clock activates the charge pump switches. The flying capacitor is charged from VIN on the first phase of the clock. On the second phase of the clock it is stacked in series with VIN and connected to VOUT. The charging and discharging the flying capacitor continues at a free running frequency of typically 1.7MHz.

In shut down (EN=logic low) mode all circuitry is turned off and the WD3168 draws only leakage current from the VIN supply. VOUT is disconnected from VIN. EN has an internal pull-down resistor and can be left floating.

The WD3168 has built-in short-circuit current limiting when output is overloaded or shorted to ground. The WD3168 ensures a limit of 500mA or less which is mandated by the HDMI electrical specification. The further avoid damage when output is shorted to ground, the short circuit protection circuitry senses the output voltage and clamp the maximum output current to a lower value, typically 90mA.

The WD3168 has thermal shutdown circuitry that protects it from damage caused by overload conditions. The thermal protection circuitry disables the output when the junction temperature reaches approximately 150°C, allowing the device to cool. When it cools to approximately 120°C, the output circuitry is automatically re-enabled.

The WD3168 has both normal constant-frequency mode and skip mode operation. As the load current falls below 4mA, it will enter skip mode. In which, the WD3168 disables the oscillator and decreases the

pre-bias current of the output stage to reduce the power consumption. As the load current rises above typically 10mA, it will return to normal constant-frequency mode, thereby re-enabling the oscillator and increasing the pre-bias current of the output stage to supply output current. Constant-frequency mode, due to higher operating current, is less efficient at light loads than skip mode. The skip threshold voltage and current depends on input voltage and output current conditions.

Tradeoffs Between Operating Modes

Feature	Skip Mode	Normal Mode
Best Light-Load Efficiency	YES	
Smallest External Component Size		YES
Output Frequency	Variable	Constant
Output Ripple	Relatively Large	Relatively Small
Load Regulation	Very Good	Good

The WD3168 charge pump circuit only requires 3 capacitors (recommended values): 1μF input, 1μF output and 1μF flying capacitors. For the input capacitor, a larger value of 4.7μF will help reduce input voltage ripple for applications sensitive to ripple on the battery voltage. All the capacitors should be surface mount ceramic for low lead inductance necessary at the 1.7MHz switching frequency and to obtain low ESR(<0.03Ω@100KHz), which improves bypassing on the input and output and improves output voltage drive by reducing output resistance. Ceramic capacitors with X5R or X7R temperature grade and 0402 or 0603 size are recommended for most applications.

The input and output capacitors should be located as close to the VIN and VOUT pins as possible to obtain best bypassing, and the returns should be connected directly to the GND pin or ground located under the WD3168. The flying capacitors should be respectively located across CP+ and CP- pins as close as possible. To obtain lower output ripple, the COUT value can be increased from 1uF to 2.2μF or to 4.7μF with a corresponding decrease in output ripple.

The efficiency of WD3168 is dominated by their quiescent current at low output currents and by their output

impedance at higher current
$$\eta = \frac{I_{OUT}(V_I - I_{OUT} \times R_O)}{(I_{OUT} + I_Q)V_I} = \frac{I_{OUT}}{(I_{OUT} + I_Q)} \left(1 - \frac{I_{OUT} \times R_O}{V_I}\right)$$

Increasing the output capacitor reduces the output ripple voltage. Decreasing its ESR reduces both output resistance and ripple. Use the following equation to calculate the peak-to-peak ripple for constant-frequency

mode:
$$V_{\text{Ripple(const-freq)}} = \frac{I_{OUT}}{2f_{OSC}C_O} + 2I_{OUT}ESR_{CO}$$

The peak-to-peak ripple for skip mode:
$$V_{\text{Ripple(skip)}} \cong \frac{(2V_I - V_{OUT})ESR_{CO}}{R_{TX}}$$
 where R_{TX} ($\sim 1.6\Omega$) is output

transfer resistance.

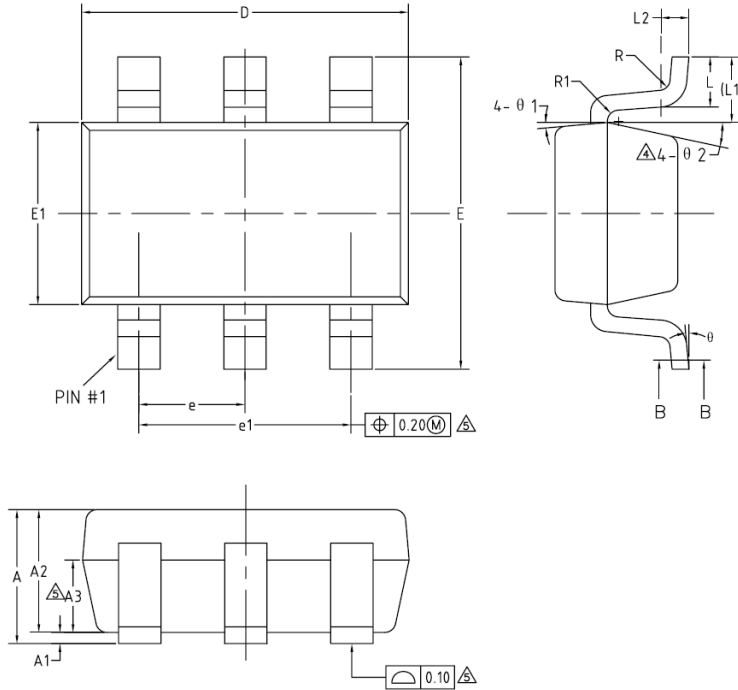
Package outline dimensions
SOT-23-6L

 COMMON DIMENSIONS
 (UNITS OF MEASURE=MILLIMETER)

SYMBOL	MIN	NOM	MAX
A	—	—	1.25
A1	0	—	0.15
A2	1.00	1.10	1.20
A3	0.60	0.65	0.70
b	0.36	—	0.50
b1	0.36	0.38	0.45
c	0.14	—	0.20
c1	0.14	0.15	0.16
D	2.826	2.926	3.026
E	2.60	2.80	3.00
E1	1.526	1.626	1.726
e	0.90	0.95	1.00
e1	1.80	1.90	2.00
L	0.35	0.45	0.60
L1	0.59REF		
L2	0.25BSC		
R	0.10	—	—
R1	0.10	—	0.20
theta	0°	—	8°
theta 1	3°	5°	7°
theta 2	6°	—	14°